

Installation, Operation and Maintenance Manual

Please read and save these instructions for future reference. Read carefully before attempting to assemble, install, operate or maintain the product described. Protect yourself and others by observing all safety information. Failure to comply with instructions could result in personal injury and/or property damage!



General Safety Information

Only qualified personnel should install this system. Personnel should have a clear understanding of these instructions and should be aware of general safety precautions. Improper installation can result in electric shock, possible injury due to coming in contact with moving parts, as well as other potential hazards, including environmental. Other considerations may be required if high winds or seismic activity are present. If more information is needed, contact a licensed professional engineer before moving forward.

1. Follow all local electrical and safety codes, as well as the National Electrical Code (NEC), the National Fire Protection Agency (NFPA), where applicable. Follow the Canadian Electrical Code (CE) in Canada.
2. All moving parts must be free to rotate without striking or rubbing any stationary objects.
3. Unit must be securely and adequately grounded.
4. Do not spin fan wheel faster than maximum cataloged fan RPM. Adjustments to fan speed significantly affect motor load. If the fan RPM is changed, the motor current should be checked to make sure it is not exceeding the motor nameplate amps.
5. Verify that the power source is compatible with the equipment.
6. Never open access doors to the unit while it is running.

DANGER

Always disconnect power before working on or near this equipment. Lock and tag the disconnect switch or breaker to prevent accidental power up.

CAUTION

When servicing the unit, the internal components may be hot enough to cause pain or injury. Allow time for cooling before servicing.

WARNING

The roof lining contains high voltage wiring. To prevent electrocution, do not puncture the interior or exterior panels of the roof.

Table of Contents

General Safety Information	1
Receiving, Handling and Storage	3
Product Overview	4
Optional Subassemblies	4
Installation	
Unit Dimensions and Weights	5
Curb Outside Dimensions, Recommended	
Roof Openings and Curb Weights	5
Service Clearances and Access Locations	6
Handling	6
Lifting	7
Roof Curb Mounting	7
Optional Piping Vestibule	8
Rail Mounting/Layout	8
Duct Connections	9
Electrical Installation	
Procedure	10
Field-Provided Disconnect	11
Discharge Air Temperature Sensor	11
Typical Control Center Components	11
Optional Accessory Wiring Schematics	12
Piping Installation	
Optional Coil Piping	13
Condensate Drain Trap	13
Unit Overview	
Basic Unit	14
Optional Component Overview	
Economizer	14
Frost Control	15
Variable Frequency Drive	15
CO ₂ Sensor	15
Rotation Sensor	15
Dirty Filter Sensor	15
Microprocessor Control	15
Unoccupied Recirculation Damper	16
Service Outlet	16
Vapor Tight Lights	16
Smoke Detector	16
Exhaust Fan Only Power	16
Airflow Monitor	16
Start-Up	
Warnings	17
Special Tools Required	17
Start-Up Procedure	17
Voltage Imbalance	17
Pre-Start-Up Checklist	18
Start-Up Checklist	18
Optional Accessories Checklist	19
Start-Up Components	
Energy Wheel	20
Fans	20-21
Vibration	21
Optional Start-Up Components	
Dirty Filter Switch	22
Economizer	22-23
Frost Control	23
Airflow Monitor	24
Variable Frequency Drives	25-26

Routine Maintenance	
Maintenance Frequency	27
Maintenance Procedures	
Lubrication	28
Dampers	28
Fan Belts	28
Fan Motors	28
Fan Wheel & Fasteners	28
Bearings	28
Internal Filter	29
External Filter	29
Coils	29
Door Seals	29
Energy Wheel	30
Troubleshooting	
Unit	31
Energy Wheel	32
Controller Alarms	33
Rotation Sensor	33
Economizer	33
Maintenance Log	34-35
Our Commitment	Backcover



Receiving

This product may have been subject to road salt during transit. If so, immediately wash off all visible white residue from all exterior surfaces. Upon receiving the product, check to ensure all line items are accounted for by referencing the delivery receipt or packing list. Inspect each crate or carton for shipping damage before accepting delivery. Alert the carrier if any damage is detected, **do not refuse shipment**. The customer shall make notation of damage (or shortage of items) on the delivery receipt and all copies of the bill of lading should be countersigned by the delivering carrier. If damaged, immediately contact your manufacturer's representative. Any physical damage to the unit after acceptance is not the responsibility of the manufacturer.

Handling

Units are to be rigged and moved by the lifting brackets provided or by the skid when a forklift is used. Location of brackets varies by model and size. Handle in such a manner as to keep from scratching or chipping the coating. Damaged finish may reduce ability of unit to resist corrosion.

Unpacking

Verify that all required parts and the correct quantity of each item have been received. If any items are missing, report shortages to your local representative to arrange for obtaining missing parts. Sometimes it is not possible that all items for the unit be shipped together due to availability of transportation and truck space. Confirmation of shipment(s) must be limited to only items on the bill of lading.

Storage

Units are protected against damage during shipment. If the unit cannot be installed and operated immediately, precautions need to be taken to prevent deterioration of the unit during storage. The user assumes responsibility of the unit and accessories while in storage. The manufacturer will not be responsible for damage during storage. These suggestions are provided solely as a convenience to the user.

The ideal environment for the storage of units and accessories is indoors, above grade, in a low humidity atmosphere which is sealed to prevent the entry of blowing dust, rain, or snow. Units designed for outdoor applications may be stored outdoors. All accessories must be stored indoors in a clean, dry atmosphere.

Indoor

Maintain temperatures evenly to prevent condensation. Remove any accumulations of dirt, water, ice, or snow and wipe dry before moving to indoor storage. To avoid condensation, allow cold parts to reach room temperature. Leave coverings loose to permit air circulation and to allow for periodic inspection.

The unit should be stored at least 3½ in. (89 mm) off

the floor. Clearance should be provided to permit air circulation and space for inspection.

Outdoor

The unit should be placed on a level surface to prevent water from leaking into the unit. The unit should be elevated so that it is above water and snow levels. Ensure sufficient support to prevent unit from settling into soft ground. Locate parts far enough apart to permit air circulation, sunlight, and space for periodic inspection. To minimize water accumulation, place all unit parts on blocking supports so that rain water will run off.

Do not cover parts with plastic film or tarps as these cause condensation of moisture from the air passing through heating and cooling cycles.

Inspection and Maintenance

While in storage, inspect units once per month. Keep a record of inspection and maintenance performed.

If moisture or dirt accumulations are found on parts, the source should be located and eliminated. At each inspection, rotate the fan wheel by hand ten to fifteen revolutions to distribute lubricant on motor. If paint deterioration begins, consideration should be given to touch-up or repainting. Units with special coatings may require special techniques for touch-up or repair.

Machined parts coated with rust preventive should be restored to good condition promptly if signs of rust occur. Immediately remove the original rust preventive coating with petroleum solvent and clean with lint-free cloths. Polish any remaining rust from surface with crocus cloth or fine emery paper and oil. Do not destroy the continuity of the surfaces. Wipe thoroughly clean with Tectyl® 506 (Ashland Inc.) or the equivalent. For hard to reach internal surfaces or for occasional use, consider using Tectyl® 511M Rust Preventive, WD-40® or the equivalent.

Removing from Storage

As units are removed from storage to be installed in their final location, they should be protected and maintained in a similar fashion until the equipment goes into operation.

Prior to installing the unit and system components, inspect the unit assembly to make sure it is in working order.

1. Check all fasteners, set screws on the fan, wheel, bearings, drive, motor base, and accessories for tightness.
2. Rotate the fan wheel(s) by hand and assure no parts are rubbing.

Product Overview

The model ERT combines the benefits of energy recovery, wrap-around heat pipe, cooling coil and optional heating sources. Heating sources include electric, hot water. Cooling sources include split direct expansion and chilled water. This product is specifically designed to process 100% outdoor air to desired supply conditions. Three housing sizes provide airflow capacities from 2,000 to 10,000 cfm with external static pressures up to 1.75 in. wg.

Optional Subassemblies

Dampers

There are four locations where dampers can be installed. Low leakage or insulated low leakage motorized dampers can be added in the outdoor airstream and/or return airstream. An unoccupied recirculating air damper is also available. A backdraft damper is standard in the exhaust hood.

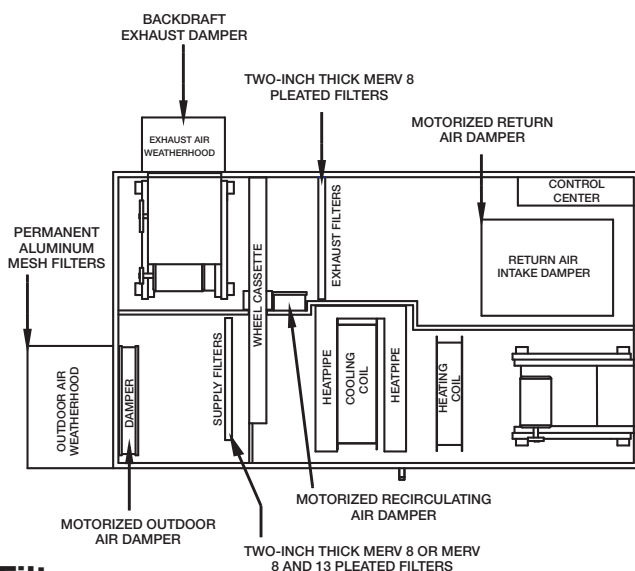

Filters

There is the option of either two-inch thick MERV 8 or MERV 8 and 13 pre-filters in the outdoor airstream and MERV 8 filters in the exhaust airstream. There are also permanent washable aluminum mesh filters in the optional weatherhood.

Hot Water / Chilled Water Coils

Water coils can be used for a single purpose such as heating or cooling, or their function can be alternated between heating and cooling by changing the temperature of the water flowing through the coil. Depending on the application, it may be necessary to use a glycol mixture to prevent the liquid from freezing. The water coils are engineered to operate at pressures up to 250 PSIG and temperatures up to 300°F, but ancillary equipment such as valves and pumps will often dictate lower operating temperatures. All water coils are pressure tested at the factory with 450 PSIG of dry nitrogen.

Split DX

The unit is equipped with an evaporator coil that will be connected to a separate condensing unit (provided by others). Depending on controlling options, the condensing unit will be controlled by others or an integral unit microprocessor controller. Piping components such as thermostatic expansion valve, filter drier, sight glass, etc., shall be field-provided.

Electric Post-Heaters

The optional post-heater is used as a heat source for the building and is integrated into the supply airstream.

A temperature sensor (with a field-adjustable set point) is mounted in the supply airstream after the post-heater to turn the post-heater on. A SCR heater allows for an infinite amount of modulating control of the heat to provide an accurate discharge temperature during the call for heat.

As standard, the post-heater control panel is not single point wired to the unit control center. Separate power must be supplied to the post-heater disconnect (located in unit control center). Electric heaters are available in 208, 230, 460, or 575 VAC (refer to heater nameplate for voltage).

Outdoor Air Weatherhood

Outdoor air weatherhood will be factory-mounted.

Exhaust Air Weatherhood

The exhaust weatherhood is shipped separately as a kit with its own instructions. Backdraft dampers are always included as an integral part of the exhaust hood assemblies.

Installation

Unit Dimensions and Weights

Model	Length	Width	Height	Exhaust Hood	Outdoor Air Hood	Approximate Weight (lbs)
ERT-45	119.3	64.4	70.2	20.7	21.7	3100
ERT-55	133.5	75.2	71	23.6	21.7	3625
ERT-90	151.5	94.5	89	25.5	26.7	5800

All dimensions are in inches. Unit weights assume rooftop configuration with weatherhood, filters, outdoor air damper, cooling options, including but not limited to a six row dx coil, and heating options (where applicable). The approximate weight (lbs) is assuming all possible accessories are added per housing and may vary by 10% depending on unit.

Curb Outside Dimensions, Recommended Roof Openings and Curb Weights

Model	Outside Curb Dimensions		Recommended Roof Openings		Optional Piping Vestibule		12 inch Curb Weight	12 inch Curb Weight with Piping Vestibule	Curb weight only	Curb Weight with Piping Vestibule
	Length	Width	A	B	C	D				
ERT-45	114.9	60	31.8	54.8	48.1	32.8	195	228	+9.5	+11.4
ERT-55	129.1	70.8	38.3	63.5	54.8	32.8	228	260	+10.9	+12.7
ERT-90	147.1	90.1	39.1	79.4	64.1	32.8	291	323	+13.1	+14.9

All dimensions are in inches. All weights are in pounds. Various curb heights are available; use the adder per inch column to determine the weights above 12 inches.

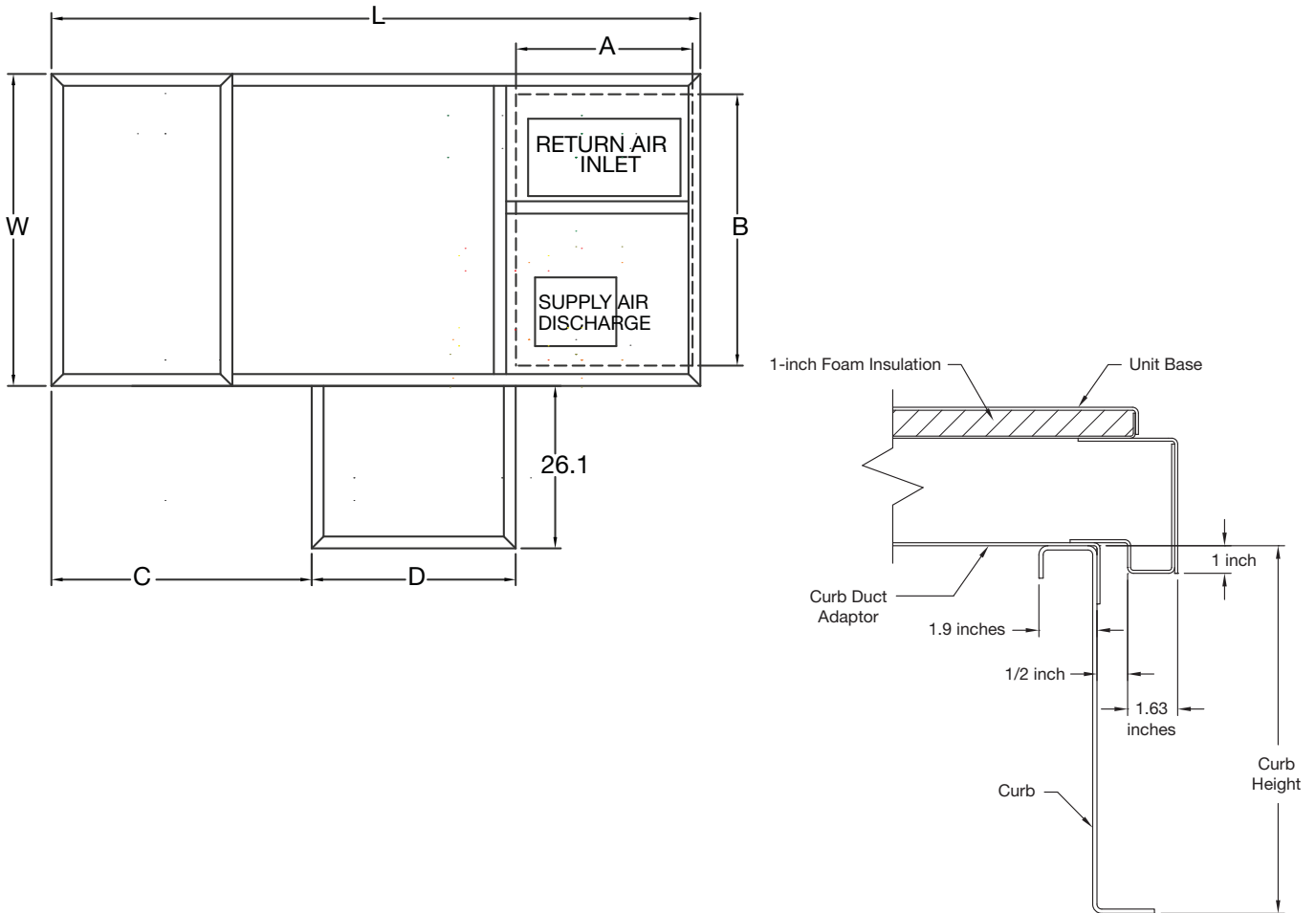

Roof Curb Detail

Service Clearances / Access Panel

Units require minimum clearances for access on all sides for routine maintenance. Filter replacement, drain pan inspection and cleaning, energy wheel cassette inspection, fan bearing lubrication and belt adjustment are examples of routine maintenance that must be performed. Blower and motor assemblies, energy recovery wheel cassette, coil and filter sections are always provided with a service door or panel for proper component access.

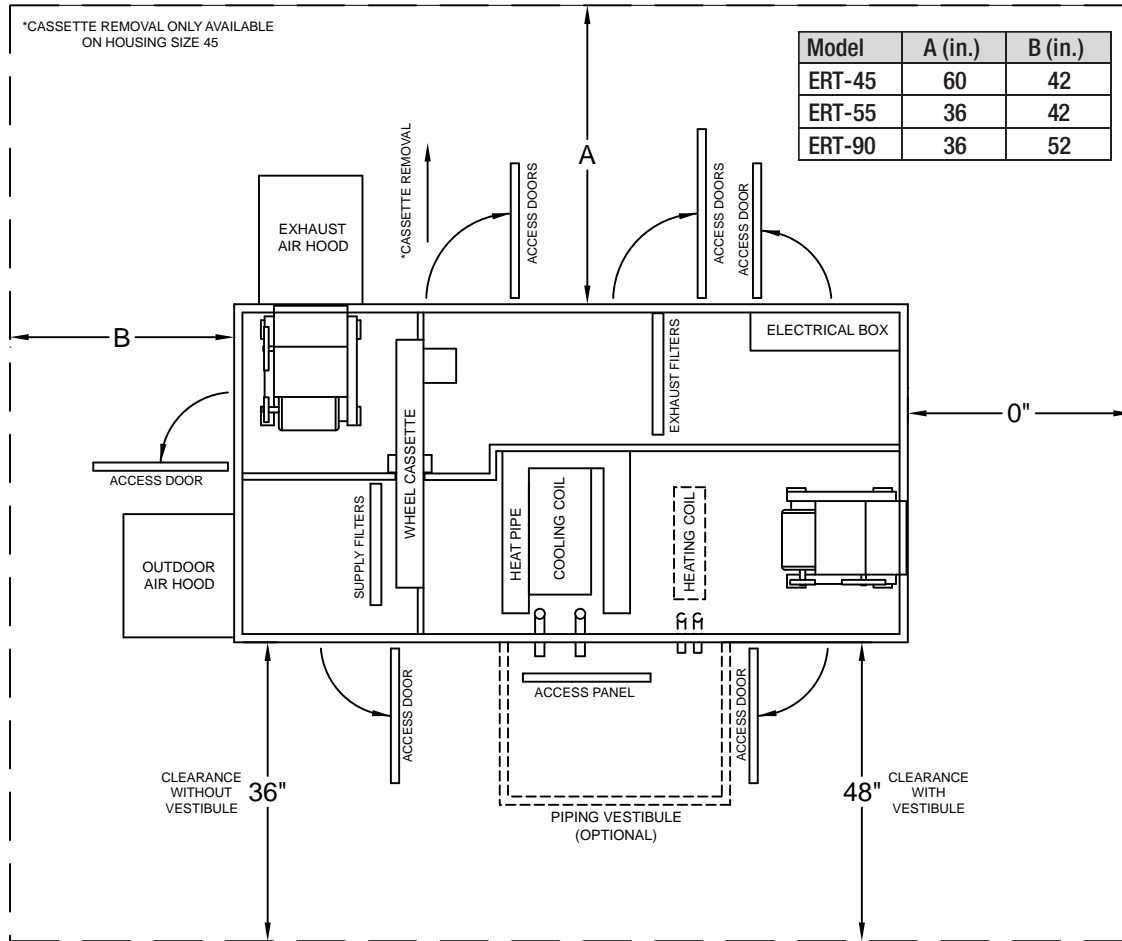

Handling

While this unit was constructed with quality and dependability in mind, damage still may occur during handling of the unit for installation.

The system design and installation should follow accepted industry practice, such as described in the ASHRAE Handbook. Adequate space should be left around the unit for piping coils and drains, filter replacement, and maintenance. Sufficient space should be provided on the side of the unit for routine service and component removal should that become necessary.

Lifting

WARNING

All factory-provided lifting lugs must be used when lifting the units. Failure to comply with this safety precaution could result in property damage, serious injury, or death.

1. Before lifting, be sure that all shipping material has been removed from unit.
2. To assist in determining rigging requirements, weights are provided in the Installation, Unit Dimensions and Weights section of this manual.
3. Unit must be lifted by all lifting lugs provided on base structure.
4. Rigger to use suitable mating hardware to attach to unit lifting lugs.
5. Spreader bar(s) must span the unit to prevent damage to the cabinet by the lift cables.

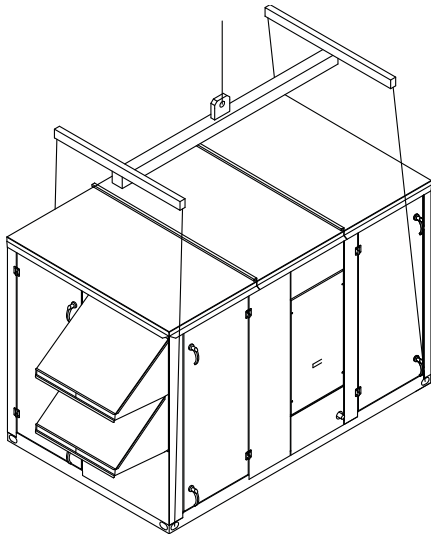

6. Always test-lift the unit to check for proper balance and rigging before hoisting to desired location.
7. Never lift units by weatherhoods.
8. Never lift units in windy conditions.
9. Preparation of curb and roof openings should be completed prior to lifting unit to the roof.
10. Check to be sure that gasketing (supplied by others) has been applied to the curb prior to lifting the unit and setting on curb.
11. Do not use fork lifts for handling unit.

NOTE

Install and caulk covers over lift points after unit is installed to ensure weatherization.

Roof Curb Mounting

Rooftop units require curbs to be mounted first. The duct connections must be located so they will be clear of structural members of the building.

Position the unit roof opening such that the supply discharge and exhaust inlet of the unit will line up with the corresponding ductwork. Be sure to allow for the recommended service clearances when positioning opening.

Do not face the outdoor air intake of the unit into prevailing wind and keep the intake away from any other exhaust fans. Likewise, position the exhaust discharge opening away from outdoor air intakes of any other equipment.

1. Factory-Supplied Roof Curbs Roof curbs are Model GKD, which are shipped in a knockdown kit (includes duct adapter) and require field assembly (by others). Assembly instructions are included with the curb.

2. Install Curb Locate curb over roof opening and fasten in place. Reference Installation, Curb Outside Dimensions, Recommended Roof Openings and Weights in this manual. Check that the diagonal dimensions are within $\pm 1/8$ inch of each other and adjust as necessary. For proper coil drainage and unit operation, it is important that the installation be level. Shim as required to level.

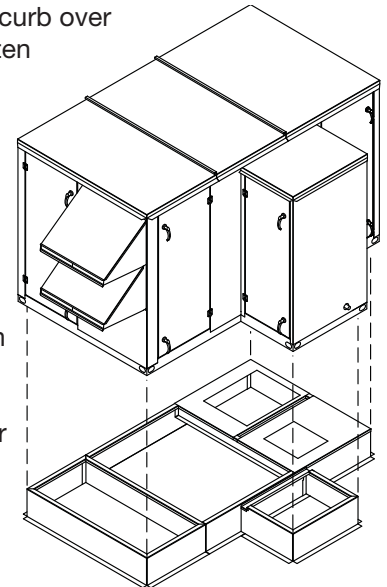

3. Install Ductwork Installation of all ducts should be done in accordance with SMACNA and AMCA guidelines. Duct adapter provided to support ducts prior to setting the unit.

4. Set the Unit Lift unit to a point directly above the curb and duct openings. Guide unit while lowering to align with duct openings. Roof curbs fit inside the unit base. Make sure the unit is properly seated on the curb and is level. Gasketing (by others) needs to be installed to curb creating a seal between the ductwork and the base of the unit.

Optional Piping Vestibule

Insulated enclosure that is mounted externally to the unit in order to protect the water supply and return piping. Not available in models with water-source heat pump or evaporative cooling.

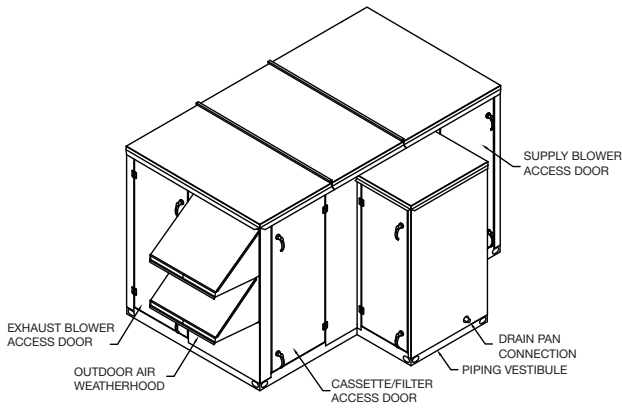

Cooling Coil (with or without heating)

Unit Size	Weight
ERT-45	235
ERT-55	235
ERT-90	280

All weights are in pounds.

Rail Mounting / Layout

1. Rails designed to handle the weight of the unit should be positioned as shown on the diagram (rails by others).
2. Make sure that rail positioning does not interfere with the supply air discharge opening or the exhaust air intake opening on the unit. Avoid area dimensioned "B" below.
3. Rails should run the width of the unit and extend beyond the unit a minimum of 12 inches on each side.
4. Set unit on rails.

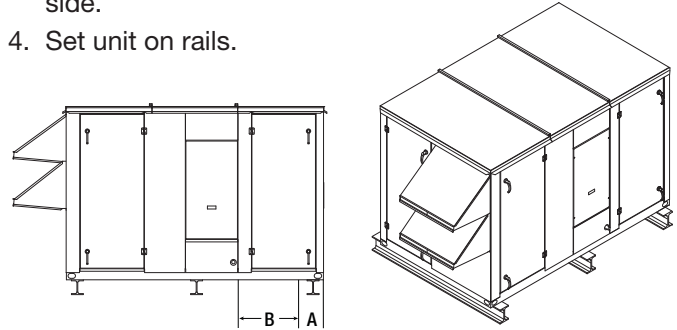

Rail Mounting		
Unit Size	A	B
ERT-45	7.0	41.9
ERT-55	5.5	53.0
ERT-90	6.0	59.0

All dimensions are in inches.

Ductwork Connections

Examples of poor and good fan-to-duct connections are shown. Airflow out of the fan should be directed straight or curve the same direction as the fan wheel rotates. Poor duct installation will result in low airflow and other system effects.

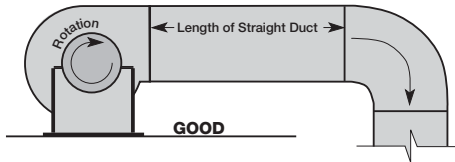
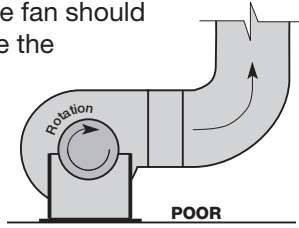

Inlet/Outlet Descriptions			
Code	Description	Code	Description
OIE	Outdoor Air Intake End	SDT	Supply Discharge Top
OIT	Outdoor Air Intake Top	SDT/IG	Supply Discharge Top w/IG
RIE	Return Air Intake End	SDS	Supply Discharge Side
RIS	Return Air Intake Side	SDB	Supply Discharge Bottom
RIB	Return Air Intake Bottom	EDE	Exhaust Discharge End
RIT	Return Air Intake Top	EDT	Exhaust Discharge Top
SDE	Supply Discharge End	EDS	Exhaust Discharge Side

ERT-45			Recommended Duct Size
Intake	Duct Size	Discharge	12-12 Blower
OIE	28 x 36	SDE	20 x 20
OIT	34 x 24	SDS	20 x 20
RIE	24 x 40	SDT	20 x 20
RIS	26 x 32	SDT/IG	28 x 28
RIB	20 x 48	SDB	16 x 18
RIT	28 x 30	EDE	20 x 20
		EDT	20 x 20
		EDS	20 x 20

ERT-55			Recommended Duct Size
Intake	Duct Size	Discharge	15-15 Blower
OIE	32 x 52	SDE	28 x 28
OIT	40 x 28	SDS	28 x 28
RIE	30 x 40	SDT	28 x 28
RIS	30 x 38	SDT/IG	38 x 30
RIB	20 x 54	SDB	18 x 20
RIT	30 x 40	EDE	28 x 28
		EDT	28 x 28
		EDS	28 x 28

ERT-90			Recommended Duct Size
Intake	Duct Size	Discharge	18-18 Blower
OIE	34 x 64	SDE	32 x 32
OIT	34 x 50	SDS	32 x 32
RIE	32 x 60	SDT	32 x 32
RIS	40 x 40	SDT/IG	34 x 33
RIB	22 x 74	SDB	20 x 24
RIT	40 x 40	EDE	32 x 32
		EDT	32 x 32
		EDS	32 x 32

All dimensions shown in inches.

- Recommended duct sizes are based on velocities across the cfm range of each model at approximately 800 feet per minute (FPM) at minimum airflow and up to 1600 fpm at maximum airflow.
- Recommended duct sizes are only intended to be a guide and may not satisfy the requirements of the project. Refer to plans for appropriate job specific duct size and/or velocity limitations.

Electrical Installation

WARNING

The roof lining contains high voltage wiring. To prevent electrocution, do not puncture the interior or exterior panels of the roof.

WARNING

To prevent injury or death due to electrocution or contact with moving parts, lock disconnect switch open.

IMPORTANT

Before connecting power to the unit, read and understand the following instructions and wiring diagrams. Complete wiring diagrams are attached on the inside of the control center door(s).

IMPORTANT

All wiring should be done in accordance with the latest edition of the National Electrical Code ANSI/NFPA 70 and any local codes that may apply. In Canada, wiring should be done in accordance with the Canadian Electrical Code.

IMPORTANT

The equipment must be properly grounded and bonded. Any wiring running through the unit in the airstream must be protected by metal conduit, metal clad cable or raceways.

CAUTION

If replacement wire is required, it must have a temperature rating of at least 105°C, except for an energy cut-off or sensor lead wire which must be rated to 150°C.

DANGER

High voltage electrical input is needed for this equipment. This work should be performed by a qualified electrician.

CAUTION

Any wiring deviations may result in personal injury or property damage. Manufacturer is not responsible for any damage to, or failure of the unit caused by incorrect final wiring.

WARNING

If unit is equipped with a microprocessor, terminals Y1, Y2 and W1 cannot be wired to a thermostat. Wiring to these terminals will bypass unit's internal safeties.

1. Determine the Size of the Main Power Lines

The unit's nameplate states the voltage and the unit's MCA. The main power lines to the unit should be sized accordingly. The nameplate is located on the outside of the unit on the control panel side.

2. Determine the Size of Electric Heater Wiring

An optional electric heater may require a separate power supply. The power connection should be made to the factory-provided electric heater disconnect and must be compatible with the ratings on the nameplate, supply power voltage, phase and amperage. Consult ANSI/NFPA 70 and CSA C22.1 for proper conductor sizing.

3. Provide the Opening(s) for the Electrical Connections

Electrical openings vary by unit size and arrangement and are field-supplied.

4. Connect the Power Supplies

Connect the main power lines and electric heater power lines to the disconnect switches or terminal blocks and main grounding lug(s). Torque field connections to manufacturer's recommendations.

5. Wire the Optional Convenience Outlet

The convenience outlet requires a separate 115V power supply circuit. The circuit must include short circuit protection which may need to be supplied by others.

6. Connect Field-Wired Low Voltage Components

Most factory-supplied electrical components are prewired. To determine what electrical accessories require additional field-wiring, refer to the unit-specific wiring diagram located on the inside of the control center access door.

Control wires should not be run inside the same conduit as that carrying the supply power. Make sure that field-supplied conduit does not interfere with access panel operation. All low voltage wiring should be run in conduit wherever it may be exposed to the weather.

The low voltage control circuit is 24 VAC and control wiring should not exceed 0.75 ohms. If wire resistance exceeds 0.75 ohms, an isolation relay should be added to the unit control center and wired in place of the remote switch (typically between terminal blocks R and G on the terminal strip). The relay must be rated for at least 5 amps and have a 24 VAC coil. Failure to comply with these guidelines may cause motor starters to "chatter" or not pull in which can cause contactor failures and/or motor failures.

Field-Provided Disconnect

If field-installing an additional disconnect switch, it is recommended that there is at least four feet of service room between the switch and system access panels. When providing or replacing fuses in a fusible disconnect, use dual element time delay fuses and size according to the rating plate.

Discharge Air Temperature Sensor

The discharge air temperature sensor is factory-mounted in the blower discharge section of the unit behind the blower cut off plate.



Typical Control Center Components with Microprocessor Control

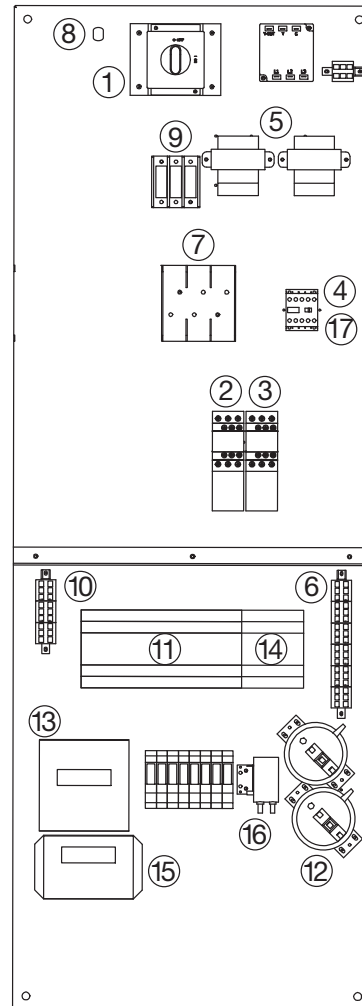

Individual components and locations will vary.

1. Main disconnect (non-fusible, lockable)
2. Motor starter - outdoor air fan
3. Motor starter - exhaust air fan
4. Motor contactor - energy wheel
5. 24 VAC control transformer
6. 24 VAC terminal strip
7. Fuses for blower motors
8. Grounding lug
9. Distribution block
10. Terminal block

Optional Components

11. Microprocessor controller
12. Dirty filter pressure switches
13. Economizer module
14. Thermostats for
 - Economizer module
 - Energy recovery wheel frost control
15. GreenTrol®
16. Frost control pressure switch
17. Energy recovery wheel VFD

Optional Accessory Wiring Schematics

Remote Panel

The remote panel is available with a number of different alarm lights and switches to control the unit. The remote panel ships loose and requires mounting and wiring in the field. The remote panel is available with the following options:

- Unit on/off switch
- Unit on/off light
- 7-day time clock
- Hand/off/auto switch
- Dirty filter light
- Economizer light
- Frost control light
- Wheel rotation sensor light



7-Day Timer

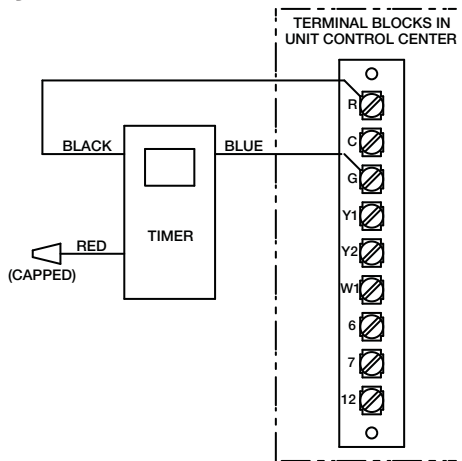

Unit Interfacing Terminals

Heating/Cooling Switches and Night Setback Switch/Timer

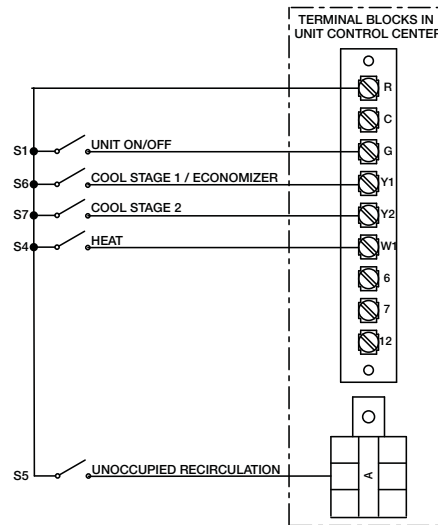

Dirty Filter Indicator

(Powered by others)

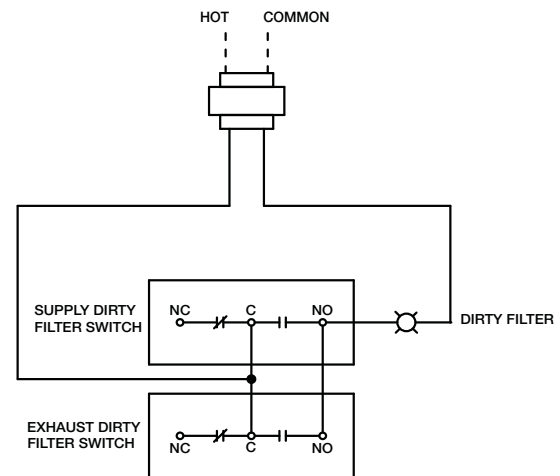

On/Off/Auto Switch & Indicator Light Wiring

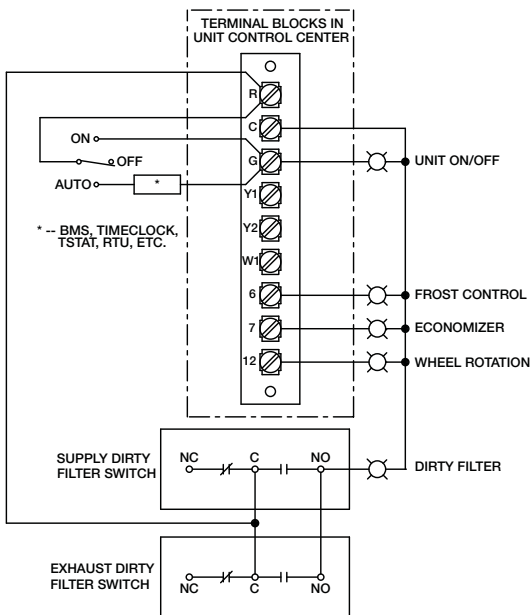

ON/OFF/AUTO SWITCH ALLOWS THREE MODES OF OPERATION
 "ON" - UNIT IS TURNED ON MANUALLY
 "OFF" - UNIT IS TURNED OFF MANUALLY
 "AUTO" - UNIT IS CONTROLLED VIA SCHEDULER OF BMS, TIMECLOCK, TSAT, ETC.

Piping Installation

Optional Coil Piping

Factory-installed cooling and heating components are mounted in the coil section of the unit. The coil section is downstream of the energy wheel on the supply air side of the unit. Note the coil connection locations on the picture. Coil connections are located external to the unit as shown.

Note: DX coil liquid connection is internal to units.

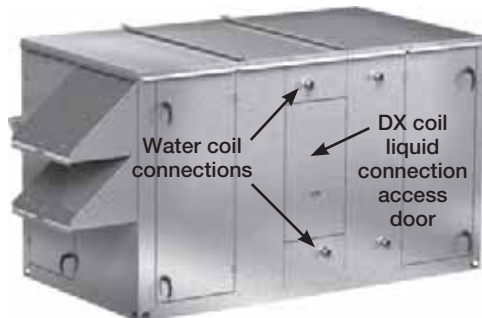

Water Coils

1. Piping should be in accordance with accepted industry standards. Pipework should be supported independently of the coils. When installing couplings, do not apply undue stress to the connection extending through the unit. Use a backup pipe wrench to avoid breaking the weld between coil connection and header.
2. Connect the water supply to the bottom connection on the air leaving side and the water return to the top connection on the air entering side. Connecting the supply and/or return in any other manner will result in very poor performance. Be sure to replace factory-installed grommets around coil connections if removed for piping. Failure to replace grommets will result in water leakage into the unit and altered performance.
3. Water coils are not normally recommended for use with entering air temperatures below 40°F. No control system can be depended on to be 100% safe against freeze-up with water coils. Glycol solutions or brines are the only safe media for operation of water coils with low entering air conditions. If glycol or brine solutions are not used, coils must be drained when freezing conditions are expected. **If required, vent and drain connections must be field-piped, external to the unit.**
4. Pipe sizes for the system must be selected on the basis of the head (pressure) available from the circulation pump. The velocity should not exceed 6 feet per second and the friction loss should be approximately 3 feet of water column per 100 feet of pipe.
5. For chilled water coils, the condensate drain pipe should be sized adequately to ensure the condensate drains properly. Refer to Condensate Drain Trap section.

Direct Expansion (DX) Coils (Split DX)

1. Piping should be in accordance with accepted industry standards. Pipework should be supported independently of the coils. Undue stress should not be applied at the connection to coil headers.
2. The condensate drain pipe should be sized adequately to ensure the condensate drains properly. Refer to Condensate Drain Trap section.
3. When connecting suction and liquid connections make sure the coil is free from all foreign material. Make sure all joints are tight and free of leakage. Be sure to replace factory-installed grommets around coil connections if removed for piping.
4. Manufacturer does not supply compressor or condensing units with standard models. For further instruction on DX coil installation and operation contact your compressor and/or condenser manufacturer.

Condensate Drain Trap

This unit is equipped with a stainless steel condensate pan with a 1-inch MPT stainless steel drain connection. It is important that the drain connection be fitted with a P trap to ensure proper drainage of condensate while maintaining internal static pressures.

A P trap assembly (kit) is supplied with each unit and is to be assembled and installed as local conditions require and according to the assembly instructions provided with the P trap. If local and area codes permit, the condensate may be drained back onto the roof, but a drip pad should be provided beneath the outlet. If local and area codes require a permanent drain line, it should be fabricated and installed in accordance with Best Practices and all codes.



In some climates, it will be necessary to provide freeze protection for the P trap and drain line. The P trap should be kept filled with water or glycol solution at all times and it should be protected from freezing to protect the P trap from damage. If severe weather conditions occur, it may be necessary to fabricate a P trap and drain line of metal and install a heat tape to prevent freezing.

Unit Overview

Basic Unit

The unit is pre-wired such that when a call for outside air is made (via field-supplied 24 VAC control signal wired to unit control center), the supply fan, exhaust fan, and energy wheel are energized and optional motorized dampers open.

The unit can be supplied with or without heating and cooling coils. For units with coils, controls can be supplied by manufacturer or by the controls contractor. If supplied by the controls contractor, they would provide, mount, and wire any temperature controllers and temperature or relative humidity sensors required for the unit to discharge air at the desired conditions. However, temperature, pressure, and current sensors can be provided by manufacturer for purposes of monitoring via the BMS.

Summer Operation

Outdoor air is preconditioned (temperature and moisture levels are decreased) by the transfer of energy from the cooler, drier exhaust air via the energy recovery wheel. Units supplied with cooling coils can further cool the air coming off the wheel and strip out moisture to levels at or below room design. A heating coil downstream of the cooling coil can reheat the air to a more comfortable discharge temperature to the space.

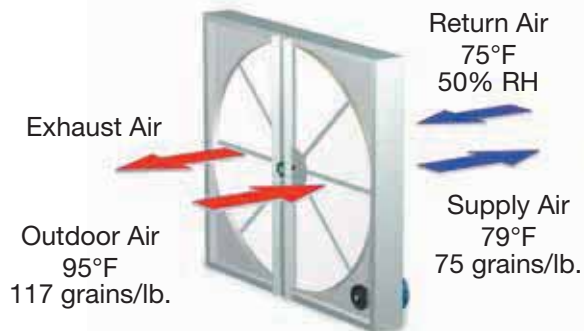

Winter Operation

Outdoor air is preconditioned (temperature and moisture levels are increased) by the transfer of energy from the warmer, more humid exhaust air via the energy recovery wheel. Units supplied with heating coils can further heat the air coming off the wheel to levels at or above room design.

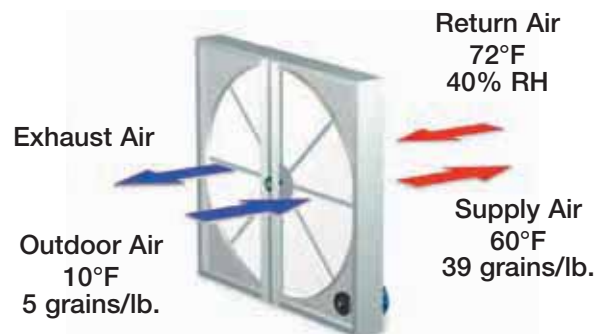

Optional Component Overview

Economizer

The energy wheel operation can be altered to take advantage of economizer operation (free cooling).

Two modes are available:

1. Stopping the wheel
2. Modulating the wheel

Stopping the wheel: A field-supplied call for cool (Y1) is required. De-energizing the wheel is accomplished in one of three ways:

1. The outdoor air temperature is less than the outdoor dry bulb set point (DRYBLB SET)
2. The outdoor air temperature is less than the return air temperature
3. The outdoor air enthalpy is within the preset enthalpy curve

A low temperature lock out (LOW T LOCK) is also set to deactivate mechanical cooling when it exceeds the outdoor air temperature (factory default 32°F). Effectively, the two sensors create a deadband where the energy recovery wheel will not operate and free cooling from the outside can be brought into the building unconditioned.

Modulating the wheel (factory): A variable frequency drive is fully programmed at the factory. A “call for cool” must be field-wired to the unit. (Terminals provided in unit. Refer to wiring diagram in unit control center). to allow for initiation of economizer mode. The unit recognizes economizer conditions based on one of the previously mention sensors and set points. The unit will then modulate the wheel speed to maintain the mixed air temperature set point (MAT SET).

Modulating the wheel (by others): A variable frequency drive is fully programmed at the factory. A field-supplied 0-10 VDC signal will be required for operation of the energy wheel. The field will be required to have full control of the energy wheel speed at all times. If no 0-10 VDC signal is provided, the energy wheel will run at the factory default of 3 Hz and no energy transfer will be captured.

Frost Control

Extremely cold outdoor air temperatures can cause moisture condensation and frosting on the energy recovery wheel. Frost control is an optional feature that will prevent/control wheel frosting. Three options are available:

1. Timed exhaust frost control
2. Electric preheat frost control
3. Modulating wheel frost control

All of these options are provided with a thermdisc mounted in the outdoor air intake compartment and a pressure sensor to monitor pressure drop across the energy wheel.

An outdoor air temperature of below 5°F and an increase in pressure drop would indicate that frost is occurring. Both the pressure sensor and the outdoor air thermdisc must trigger in order to initiate frost control. The two sensors together ensure that frost control is only initiated during a real frost condition.

Timed exhaust frost control includes a timer in addition to the thermdisc and wheel pressure sensor. When timed exhaust frost control is initiated, the timer will turn the supply blower off. Timed exhaust, using default timer setting, will shut down the supply fan for 5 minutes every 30 minutes to allow exhaust to defrost energy wheel. Use the test procedure in the Optional Start-Up Accessories section for troubleshooting.

Electric preheat frost control includes an electric heater (at outdoor air intake) in addition to the thermdisc and pressure sensor on wheel. When electric preheat frost control is initiated, the electric preheater will turn on and warm the air entering the energy wheel to avoid frosting. Use the test procedure in the Optional Start-Up Accessories section for troubleshooting.

Modulating wheel frost control includes a variable frequency drive (VFD) in addition to the thermdisc and pressure sensor. When modulating wheel frost control is initiated, the VFD will reduce the speed of the wheel. Reducing the speed of the energy wheel reduces its effectiveness, which keeps the exhaust air condition from reaching saturation, thus, eliminating condensation and frosting. If the outdoor air temperature is greater than the frost threshold temperature OR the pressure differential is less than the set point, the wheel will run at full speed. If the outdoor air temperature is less than 5°F **AND** the pressure differential is greater than the set point, the wheel will run at reduced speed until the pressure differential falls below the set point. The VFD will be fully programmed at the factory.

Variable Frequency Drives (VFD)

Variable frequency drives are used to control the speed of the fan as either multi-speed or modulating control. Multi-speed VFDs reference a contact which can be made by a switch or a sensor with a satisfied set point. Modulating control references a 2-10 VDC signal to the VFD which will vary the fan speed from a minimum 50% to full 100% rpm. An optional CO₂ sensor is available to provide both a set point contact or a modulating 2-10 VDC signal.

CO₂ Sensor

This accessory is often used in Demand Control Ventilation (DCV) applications. The factory-provided sensors can either be set to reference a set point for multi-speed operation, or output a 2-10 VDC signal to modulate the fan speed. These can either be shipped loose to mount in the ductwork, or can be factory-mounted in the return air intake. Follow instructions supplied with sensor for installation and wiring details.

Rotation Sensor

The rotation sensor monitors energy wheel rotation. If the wheel should stop rotating, the sensor will close a set of contacts in the unit control center. Field-wiring of a light (or other alarm) between terminals R and 12 in the unit control center will notify maintenance personnel when a failure has occurred.

Dirty Filter Sensor

Dirty filter sensors monitor pressure drop across the outdoor air filters, exhaust air filters, or both. If the pressure drop across the filters exceeds the set point, the sensor will close a set of contacts in the unit control center. Field-wiring of a light (or other alarm) to these contacts will notify maintenance personnel when filters need to be replaced. The switch has not been set at the factory due to external system losses that will affect the switch. This switch will need minor field adjustments after the unit has been installed with all ductwork complete. The dirty filter switch is mounted in the exhaust inlet compartment next to the unit control center or in unit control center.

Microprocessor Control

The microprocessor controller is specifically designed and programmed to optimize the performance of



the unit with supplemental heating and cooling. This option ensures that the outdoor air is conditioned to the desired discharge conditions. The controller and accompanying sensors are factory-mounted, wired and programmed. Default settings are pre-programmed, but are easily field-adjustable.

The microprocessor controller can be interfaced with a Building Management System through LonWorks®, BACnet®, or ModBus.

Please refer to the DDC Controller for Energy Recovery Installation, Operation and Maintenance manual for detailed information.

Unoccupied Recirculation Damper (not offered with electric heat units)

The unoccupied recirculation option provides a recirculation damper from the return air intake to the supply airstream to reduce heating and cooling loads when less ventilation is required. During the unoccupied mode, the exhaust fan will remain off and the supply air fan will operate with mode of tempering to maintain unoccupied temperature set point.

Service Outlet

120 VAC GFCI service outlet ships loose for field installation. Requires separate power source so power is available when unit main disconnect is turned off for servicing.

Vapor Tight Lights

Vapor tight lights provide light to each of the compartments in the energy recovery unit. The lights are wired to a junction box mounted on the outside of the unit. The switch to turn the lights on is located in the unit control center. The switch requires a separate power source to allow for power to the lights when the unit main disconnect is off for servicing.

Smoke Detector

The Hochiki America DH-98 duct smoke detector provides early detection of smoke and products of combustion present in air moving through HVAC duct systems. The DH-98-P is designed to prevent the recirculation of smoke in areas by the air handling systems, fans, and blowers. Complete systems may be shut down in the event of smoke detection. The Hochiki America DH-98-P operate on 115 VAC, 24 VAC and 24 VDC.



The DH-98-P is designed and built to meet all local requirements, as well as the NFPA regulations regarding

duct smoke detectors. Output terminals are provided for remote accessories such as a horn, strobe, remote status indicators and reset key switches or push buttons.

Refer to Hochiki America DH-98-P installation instructions for further detail.

Optional Exhaust Fan Only Power

The exhaust fan will have a dedicated power circuit where in the case of a power outage, the exhaust fan will still run. A phase monitor will detect an outage or power loss and open the contact, disconnecting all power to the unit and controller. An external signal will need to be sent to a relay to power the exhaust fan, enabling the fan to run at a maximum speed. This sequence is NOT to be used for high temperature exhaust applications.

Airflow Monitor

A factory-wired, mounted, and powered airflow monitoring system is provided in the outdoor and/or exhaust air streams. The airflow control system offers the following functionality:

- Display of outdoor and/or exhaust airflow rate in actual cubic feet per minute (CFM) or actual liters per second (LPS) on a 16 character LCD display.
- Two configurable analog outputs for transmitting outdoor and/or exhaust airflow rate, outdoor air temperature, or a proportional-integral-derivative (PID) control signal based on an outdoor airflow set point.
- A configurable digital output that operates based on an airflow set point or range.

Operation

Outdoor and/or exhaust airflow monitoring is accomplished using two thermal dispersion sensors that accurately measure airflow velocity down to zero feet per minute (fpm). The airflow controller takes the average measurement for two sensor configurations, and determines the outdoor airflow rate based on the effective intake area. Field calibration of the outdoor airflow monitoring device determines the effective intake area of the unit.

Refer to GreenTrol® Automation Inc. GF-N2211 technical data sheet for further detail.

IMPORTANT

For the airflow monitoring device to perform as intended, field calibration is required. Calibration of the airflow monitoring device requires an independent measurement of airflow and should be performed when the system undergoes test and balance.

Start-Up Unit

DANGER

Electric shock hazard. Can cause injury or death. Before attempting to perform any service or maintenance, turn the electrical power to unit to OFF at disconnect switch(es). Unit may have multiple power supplies.

CAUTION

Use caution when removing access panels or other unit components, especially while standing on a ladder or other potentially unsteady base. Access panels and unit components can be heavy and serious injury may occur.

CAUTION

Do not operate without the filters and birdscreen installed. They prevent the entry of foreign objects such as leaves, birds, etc.

CAUTION

Do not run unit during construction phase. Damage to internal components may result and void warranty.

WARNING

- Unit was factory tested. All blowers and fans are set-up to run correctly when supplied power. If any one fan is running backwards or making loud noises, immediately turn off the power. Switch two leads on the incoming power to the disconnect. This will ensure proper operation of the unit. Failure to comply may void the warranty.
- Do not jumper any safety devices when operating the unit. This may damage components within or cause serious injury or death.

SPECIAL TOOLS REQUIRED

- Voltage Meter (with wire probes)
- Amperage Meter
- Pressure Gauges – (refrigerant)
- Tachometer
- Thermometer
- U-tube manometer or equivalent

Start-Up Procedure

The unit will be in operational mode during start-up. Use necessary precautions to avoid injury. All data must be collected while the unit is running. In order to measure volts and amps, the control center door needs to be open and the unit energized.

- Make sure Pre-Start-Up checklist is complete.
- Jumper R to G to enable unit. Jumper R to Y1 and R to Y2 to enable cooling and R to W1 to enable heat for units without microprocessor.
- Turn the disconnect on. Make sure all fans are rotating the correct direction.
- Allow the unit to run until the refrigerant system stabilizes. Approximately 10-15 minutes.

Voltage Imbalance

In a three-phase system, excessive voltage imbalance between phases will cause motors to overheat and eventually fail. Maximum allowable imbalance is 2%. To determine voltage imbalance, use recorded voltage measurements in this formula.

Key: V1, V2, V3 = line voltages as measured
VA (average) = $(V1 + V2 + V3) / 3$
VD = Line voltage (V1, V2 or V3) that deviates farthest from average (VA)

Formula: % Voltage Imbalance = $[100 \times (VA - VD)] / VA$

Pre Start-Up

Every installation requires a comprehensive start-up to ensure proper operation of the unit. As part of that process, the following checklist must be completed and information recorded. Starting up the unit in accordance with this checklist will not only ensure proper operation, but will also provide valuable information to personnel performing future maintenance. Should an issue arise which requires factory assistance, this completed document will allow unit experts to provide quicker resolve. Qualified personnel should perform start-up to ensure safe and proper practices are followed.

Unit Model No. _____

Unit Serial No. _____

Energy Wheel Serial Number _____

Start-Up Date _____

Start-Up Personnel Name _____

Start-Up Company _____

Phone Number _____

Pre Start-Up Checklist

- Disconnect and lock-out all power switches.
- Remove any foreign objects that are located in the energy recovery unit.

- Check all fasteners, set-screws, and locking collars on the fans, bearings, drives, motor bases and accessories for tightness.
- Check fan rotation.
- Rotate the fan wheels and energy recovery wheels by hand and ensure no parts are rubbing.
- Check the fan belt drives for proper alignment and tension.
- Filters can load up with dirt during building construction. Replace any dirty pleated filters and clean the aluminum mesh filters in the intake hood.
- Verify that non-motorized dampers open and close properly.
- Check the tightness of all electrical wiring connections.
- Verify control wire gauge.
- Verify diameter seal settings on the energy recovery wheel.
- Verify proper drain trap installation.
- Inspect all coils within the unit. Fins may get damaged in transit or during construction. Carefully straighten fins with a fin comb.

Start-Up Checklist

Line Voltage. Check at unit disconnect.

L1-L2 _____ Volts L2-L3 _____ Volts L1-L3 _____ Volts

Motor Amp Draw

Supply Motor Amps L1 _____ Amps L2 _____ Amps L3 _____ Amps

Exhaust Motor Amps L1 _____ Amps L2 _____ Amps L3 _____ Amps

Fan RPM

Correct fan rotation direction?

Supply Fan _____ RPM

Supply Fan Yes / No

Measured Airflow _____ CFM

Exhaust Fan _____ RPM

Exhaust Fan Yes / No

Measured Airflow _____ CFM

Energy Wheel Motor

L1 _____ Amps L2 _____ Amps L3 _____ Amps

Heating System / Electric Heat

Pre-Heater L1-L2 _____ Volts L2-L3 _____ Volts L1-L3 _____ Volts

 L1 _____ Amps L2 _____ Amps L3 _____ Amps

 _____ Temp. Rise

Post-Heater L1-L2 _____ Volts L2-L3 _____ Volts L1-L3 _____ Volts

 L1 _____ Amps L2 _____ Amps L3 _____ Amps

 _____ Temp. Rise

Optional Accessories Checklist

Refer to the respective sections in this Installation, Operation and Maintenance Manual for detailed information. Refer to wiring diagram in unit control center to determine what electrical accessories were provided.

Frost Control Application / Operation Section:			Setting	Factory Default
Yes	No	Frost Control set point	_____	5°F
		Differential	_____	2°F
		Timer	_____	Refer to IOM
Yes	No	Frost Control Modulating	_____	Refer to IOM

Economizer Application / Operation Section:				
Yes	No	Economizer (temperature)		
		Set point	_____	65°F
		Offset	_____	20°F
Yes	No	Differential	_____	2°F
		Economizer (enthalpy)		
		Set point	_____	B
Yes	No	Economizer (modulating)	_____	Refer to IOM

Optional Accessories Section:			Operational		
Yes	No	Wheel Rotation Sensor ($\frac{1}{8}$ in. from wheel)	Yes	No	N/A
Yes	No	OA Dirty Filter Sensor	Yes	No	N/A
Yes	No	EA Dirty Filter Sensor	Yes	No	N/A
Yes	No	CO ₂ Sensor	Yes	No	N/A
Yes	No	Service Outlet	Yes	No	N/A
Yes	No	Vapor Tight Lights	Yes	No	N/A
Yes	No	Remote Control Panel	Yes	No	N/A

Variable Frequency Drives Section:			Operational		
Yes	No	Blower VFDs	Yes	No	N/A
Yes	No	Wheel VFD	Yes	No	N/A

Damper Section:			Operational		
Yes	No	Outdoor Air Damper	Yes	No	N/A
Yes	No	Exhaust Air Damper	Yes	No	N/A
Yes	No	Night Setback Damper	Yes	No	N/A

Outdoor Air Monitoring:		
Yes	No	Field calibrated.

Start-Up Components

Energy Wheel

The energy wheel is installed in the unit's airstream with one half of the wheel in the intake airstream and one half in the return airstream. Air leakage between the two airstreams has to be kept to a minimum and the wheel has air seals that must be adjusted for that purpose. The seals must be adjusted at time of start-up.

Drive Belt

Inspect the drive belt. Make sure the belt rides smoothly in the pulley and around the outside of the wheel. Note the directional arrow and data information shown in the image.

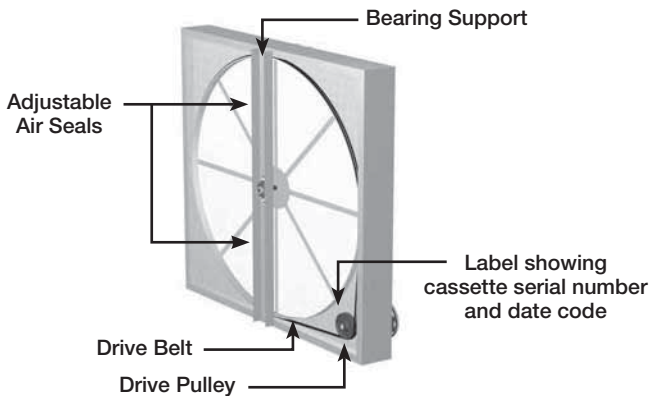

Adjust the Air Seals

The first step in wheel seal adjustment is to make sure the unit power supply is locked out. Disconnect the wiring to the wheel module and pull the wheel cassette out of the cabinet on its tracks. Large cassettes are not removable. Then slowly rotate the wheel by hand to make sure there is no binding or misalignment. The wheel should rotate smoothly and should not bind.

There is a perimeter seal located around the outside of the wheel and a diameter seal across the face of the wheel on both sides. Check to make sure that all air seals are secure and in good condition.

Adjust the air seals by loosening all the air seal retaining screws on the bearing support (see image for reference). Using a piece of paper as a feeler gauge, adjust the seals so they almost touch the face of the wheel while tugging slightly on the paper. When the wheel is rotated, there should be a slight tug on the paper. Tighten the screws, repeat the steps on the other set of seals.

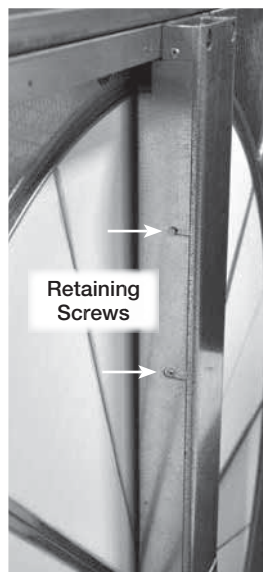

Bearing Support Bar Showing air seal assembly

Push the wheel cassette back into the unit and plug in the power connector. Turn the main power supply back on and then observe the operation of the wheel by opening the wheel access door slightly. Remove filters if necessary to observe the wheel.

Fans

The unit contains a double inlet airfoil fan and should be checked for free rotation. If any binding occurs, check for concealed damage and foreign objects in the fan housing. Be sure to check the belt drives per the start-up recommendations in the Fan Belt Drive section.

Centering of the fan wheel can be accomplished by loosening the wheel hub set screw and moving the wheel to the desired position.

Fan Performance Modifications

CAUTION

When operating conditions of the fan are to be changed (speed, pressure, temperature, etc.), consult manufacturer to determine if the unit can operate safely at the new conditions.

Due to job specification revisions, it may be necessary to adjust or change the sheave or pulley to obtain the desired airflow at the time of installation. The start-up technician must check blower amperage to ensure that the amperage listed on the motor nameplate is not exceeded. Amperage to be tested with access doors closed and ductwork installed.

Fan Belt Drives

The fan belt drive components, when supplied by manufacturer, have been carefully selected for the unit's specific operating condition. Utilizing different components than those supplied could result in unsafe operating conditions which may cause personal injury or failure of the following components:

- Fan Shaft
- Fan Wheel
- Bearings
- Belt
- Motor

Tighten all fasteners and set screws securely and realign drive pulleys after adjustment. Check pulleys and belts for proper alignment to avoid unnecessary belt wear, noise, vibration and power loss. Motor and drive shafts must be parallel and pulleys in line (see diagrams in Belt Drive Installation section).

Belt Drive Installation

1. Remove the protective coating from the end of the fan shaft and assure that it is free of nicks and burrs.
2. Check fan and motor shafts for parallel and angular alignment.
3. Slide sheaves on shafts. Do not drive sheaves on as this may result in bearing damage.
4. Align fan and motor sheaves with a straightedge to centerline.
5. Place belts over sheaves. Do not pry or force belts, as this could result in damage to the cords in the belts.
6. With the fan off, adjust the belt tension by moving the motor base. (See belt tensioning procedures in the Routine Maintenance section of this manual).
When in operation, the tight side of the belts should be in a straight line from sheave to sheave with a slight bow on the slack side.



Pulley alignment example

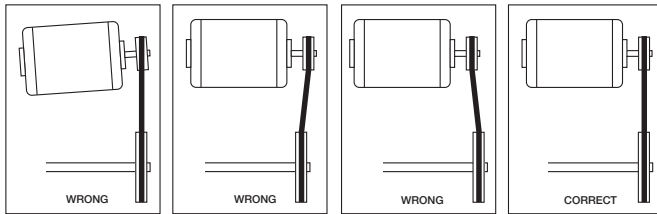

Proper alignment of motor and drive shaft.

Direction of Fan Wheel Rotation

Blower access is labeled on unit. Check for proper wheel rotation by momentarily energizing the fan. Rotation is determined by viewing the wheel from the drive side and should match the rotation decal affixed to the fan housing.

If the wheel is rotating the wrong way, direction can be reversed by interchanging any two of the three electrical leads. Check for unusual noise, vibration, or overheating of bearings. Refer to the Troubleshooting section of this manual if a problem develops.

Fan RPM

Supply fan and exhaust fan will have an adjustable motor pulley (on 15 HP and below) preset at the factory to the customer-specified RPM. Fan speed can be increased or decreased by adjusting the pitch diameter of the motor pulley. Multi-groove variable pitch pulleys must be adjusted an equal number of turns open or closed. Any increase in fan speed represents a substantial increase in load on the motor. Always check the motor amperage reading and compare it to the amperage rating shown on the motor nameplate when changing fan RPM. All access doors must be installed except the control center door.

WARNING

Do not operate units with access doors open or without proper ductwork in place as the fan motors will overload.

Model	Blower Diameter x Width (inches)	Maximum RPM for Backward-Curved Blowers
ERT-45	12 x 12	3700
ERT-55	15 x 15	2900
ERT-90	18 x 18	2450

Vibration

Excessive vibration may be experienced during initial start-up and can cause a multitude of problems, including structural and/or component failure.

Vibration Causes

Off axis or loose components
Drive component unbalance
Poor inlet / outlet conditions
Foundation stiffness

Many of these conditions can be discovered by careful observation. Refer to the Troubleshooting section of this manual for corrective actions.

If observation cannot locate the source of vibration, a qualified technician using vibration analysis equipment should be consulted. If the problem is wheel unbalance, in-place balancing can be done.

Generally, fan vibration and noise is transmitted to other parts of the building by the ductwork. To eliminate this undesirable effect, the use of heavy canvas connectors is recommended.

Optional Start-Up Components

Dirty Filter Switch

To adjust the switch, the unit must be running with all of the access doors in place, except for the compartment where the switch is located (exhaust intake compartment). The adjusting screw is located on the top of the switch.

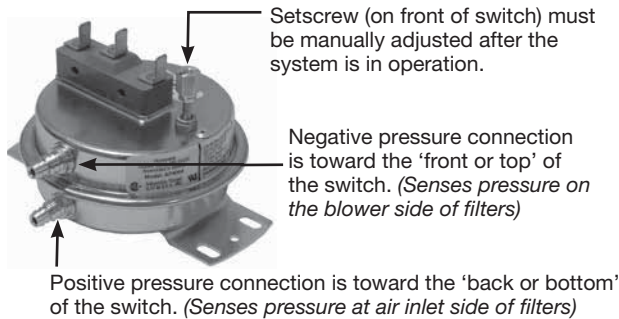

1. Open the filter compartment and place a sheet of plastic or cardboard over 50% of the filter media.
2. Replace the filter compartment door.
3. Check to see if there is power at the alert signal leads (refer to electrical diagram).
4. Whether there is power or not, turn the adjustment screw on the dirty filter gauge (clockwise if you did not have power, counterclockwise if you did have power) until the power comes on or just before the power goes off.
5. Open the filter compartment and remove the obstructing material.
6. Replace the door and check to make sure that you do **not** have power at the alert signal leads. The unit is now ready for operation.

Economizer

Relevant Set Points

1. **MAT SET** The mixed air temperature set point after the energy wheel. The control will modulate the energy wheel to maintain temperature as best as it can (Set point menu, default 53°F)
2. **LOW T LOCK** The set point for the low temperature mechanical cooling lockout. (Set point menu, default 32°F)
3. **DRYBLB SET** The outdoor air set point to call for economizer. (Set point menu, default 63°F)
4. **MIN POS** The minimum signal voltage sent to the energy wheel. This must be set to 2 VDC. (Set point menu, default 2.8 VDC)
5. **AUX1 O** The controllers operating sequence structure. (Set point menu, default 'None')
6. **ERV OAT SP** The set point for low temperature economizer lockout. This is the low temperature set point when AUX1 O is set to ERV. (Set point menu, default 32°F)
7. **STG3 DLY** Time delay after second cooling stage is enabled (Advanced setup menu, default 2 hrs.)

Using the Keypad with Settings and Parameters

To use the keypad when working with Set Points, System and Advanced Settings, Checkout Tests, and Alarms:

1. Navigate to the desired menu.
2. Press **↵** (enter) to display the first item in the currently displayed menu.
3. Use the **▲** and **▼** buttons to scroll to the desired parameter.
4. Press **↵** (enter) to display the value of the currently displayed item.
5. Press the **▲** button to increase (change) the displayed parameter value.^a
6. Press the **▼** button to increase (change) the displayed parameter value.^a
7. Press **↵** (enter) to accept the displayed value and store it in non-volatile RAM.
8. CHANGE STORED displays.
9. Press **↵** (enter) to return the current menu parameter.
10. Press **⏪** (escape) to return to the current menu parameter.

^a When values are displayed, pressing and holding the **▲** or **▼** button causes the display to automatically increment.

The table shows which set points are relevant to the given sequences. Refer to the wiring diagram for the units' sequence.

	MODULATE WHEEL			STOP WHEEL		
	OA Temp	OA Enthalpy	OA/RA Temp Differential	OA Temp	OA Enthalpy	OA/RA Temp Differential
DRYBLB SET	X			X		
MAT SET	X	X	X	X	X	X
LOW T LOCK	X	X	X	X	X	X
ERV OAT SP				X	X	X
MIN POS	X	X	X			
AUX1 OUT				ERV	ERV	ERV
STG3 DLY	X	X	X	X	X	X

Stop Wheel

1. Navigate to the Checkout menu and press ⏏ (enter).
2. The energy wheel and cooling should stop.
3. Navigate to Connect ERV and press ⏏ (enter) twice to run the test.
4. Voltage between AUX1-O and C should be 24 VAC. The energy wheel should activate.

Modulate Wheel

1. Navigate to the Checkout menu and press ⏏ (Enter).
2. The cooling should turn off and the wheel should be rotating at full speed.
3. Navigate to Damper Open and press ⏏ (enter) twice to run the test.
4. Voltage between terminals ACT 2-10 and ACT COM should be 10 VDC. This will slow the wheel down to minimum speed.
5. Press ⏏ (escape), navigate to Damper Close and press ⏏ (enter) twice to run the test.
6. Voltage between terminal ACT 2-10 and ACT COM should be 2 VDC. This will speed the wheel up to maximum speed.

Frost Control

Timed Exhaust

1. Remove power from unit.
2. Jumper the frost indicating wheel pressure switch in the unit control center.
3. Jumper the temperature indicating thermodisc in the unit control center. Thermodisc has a pre-set temperature of 5°F.
4. Set the frost control timer scale for T1 and T2 to 1m. Set the timer settings for T1 and T2 to 10.
5. Add power to the unit. Blower should cycle on for one minute, then turn off for one minute.
6. Remove power from unit and remove jumpers that were placed. Reset timer settings.

- **T1** timer setting set to **5** and timer scale set to **10m** for 5 minutes of wheel off time.

- **T2** timer setting set to **5** and timer scale set to **1h** for 30 minutes of wheel on time.

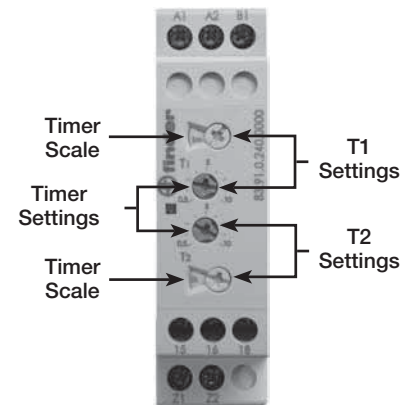

Electric Preheat

1. Remove power from unit.
2. Jumper the frost indicating wheel pressure switch in the preheat control center.
3. Jumper the temperature indicating thermodisc in the preheat control center. Thermodisc has a pre-set temperature of 5° F.
4. Apply power to unit. Preheater should turn on.

Outdoor Airflow Monitor

For additional information on how to navigate through the airflow controller menus, refer to the technical manuals GF-2200A from GreenTrol® Automation Inc. at www.greentrol.com.

Field calibration procedure:

1. Turn off power to the unit using the power disconnect(s).
2. Remove the cover from the GreenTrol airflow monitoring controller.
3. Install a jumper wire between terminals R and G on the unit's terminal board if one isn't present.
4. When safe, turn the power back on to the unit using the power disconnect(s).

If no microprocessor controller, skip to step 8.

Steps 5 thru 7 are for microprocessor only.

5. Look at the unit's microprocessor controller screen and view the status of the unit. If the displayed status is "System Off" continue with step 6, otherwise go to step 7.
6. Adjust the unit on/off priorities on the unit's microprocessor controller so the unit will run for calibration.
 - a. Push the "Prg" button on the microprocessor controller.
 - b. Use the up and down arrows to get to the "On/Off Unit" menu.
 - c. Push the Enter button to view the current unit on/off priorities.
 - d. Push the down arrow to display the Unit ON/OFF Control screen.
 - e. Record the settings so they can be changed back when calibration is complete:
By digit input: _____
By BMS: _____
By Scheduler: _____
 - f. Use the Enter button to navigate between the different settings on the page, use the up and down arrows to change the values so that "By digit input" is the only setting with "Yes".
7. Enter the service override menu to control the damper position.
 - a. At the Home Screen push the "Prg" button. (If you're not at the home screen, push the Escape button until you get there).
 - b. Use the up and down arrows to get to the "Service" menu, then push the Enter button.
 - c. If you're asked for a password, enter "1000" for the password and push Enter.
 - d. Use the up and down arrows to get to the "Overrides" screen, then push Enter.
 - e. Use the arrow buttons to get the supply override.

8. Measure the supply airflow rate of the unit using an approved test and balance method.
9. Without making any changes to the system, calibrate the airflow monitoring controller so it reads the airflow measured in step 8 by using the Field Calibration Wizard.
 - a. The field calibration lasts for two minutes. Any significant changes in airflow will affect the accuracy of the reading.
 - b. To enter the Field Calibration Wizard, hold the Down and Enter buttons simultaneously on the airflow controller, then release the buttons.
 - c. Push the Enter button to access Wizard 1
 - d. Push the Enter button twice and change Wiz1 Enable to YES.
 - e. When asked for the number of calibration points (Cal Points), set the value to 1.
 - f. Push the Enter button when the display says "Set Flow 1".
 - g. After completing the steps above, set the FLOW1 value to the airflow measured in step 8, then push the Enter button to begin calibration.
10. After the calibration is completed, measure the supply airflow rate again and compare with the value on the airflow controller's display
 - a. If the values are within 5% of each other the device has been successfully calibrated.
 - b. If the values are not within 5% of each other repeat the field calibration process.
11. If you had to change the On/Off priorities on the microprocessor unit controller, change them back to the values that were written down in step 6.
12. Turn off power to the unit using the power disconnect(s) and wait one minute for the variable frequency drive(s) to lose backup power.
13. Replace the cover to the GreenTrol airflow monitoring station.
14. If you added a jumper between terminals R and G in step 3, remove it at this time. If a jumper was already in place, leave it in place.
15. When safe, turn the power back on to the unit using the power disconnect(s).
Recycling of the power resets the manual override values that were set during the calibration.

Variable Frequency Drives

Optional factory-installed, wired, and programmed variable frequency drives (VFDs) may have been provided for modulating or multi-speed control of the blowers and energy recovery wheel for economizer and frost control modes. One VFD, either Yaskawa model V1000 or J1000, is provided for each blower (supply air and exhaust) and one Yaskawa model J1000 is provided for the energy recovery wheel.

Refer to the tables in this section for factory settings and field wiring requirements. Refer to the unit control center for unit specific wiring diagram. When making adjustments outside of the factory set points, refer to Yaskawa VFD instruction manual, which can be found online at www.drives.com. For technical support, contact Yaskawa direct at 1-800-927-5292.

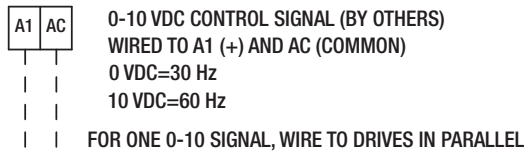
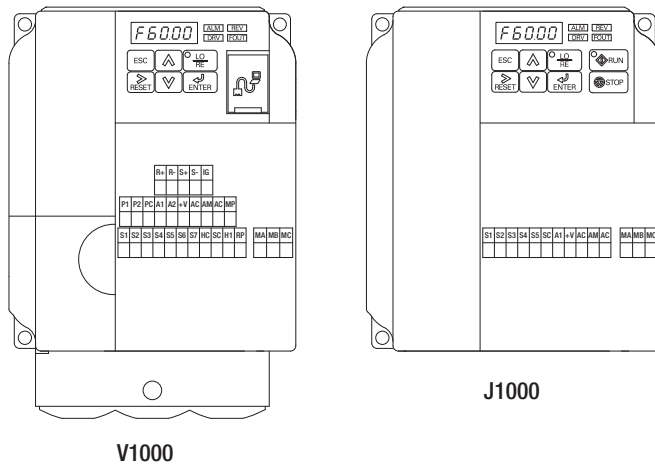

SEE VFD INSTALLATION MANUAL FOR MORE DETAIL
FOR CONTINUOUS 60Hz OPERATION JUMPER TERMINALS A1 AND +V.

OPTION 2 - MULTI SPEED CONTROL
USER TO PROVIDE CONTACTS AND ISOLATION AS REQUIRED

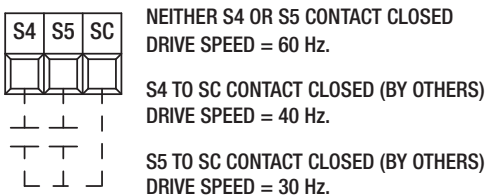

SEE VFD INSTALLATION MANUAL FOR MORE DETAIL
TO CHANGE THE FACTORY SET Hz CHANGE THE FOLLOWING PARAMETERS.
PARAMETER A1-01 CHANGE TO 2
PARAMETER d1-01 FOR NEW 60Hz SETTING
PARAMETER d1-02 FOR NEW 40Hz SETTING
PARAMETER d1-03 FOR NEW 30Hz SETTING
PARAMETER A1-01 CHANGE TO 0

Factory Set Points

Variable frequency drives (VFDs) for the blowers are factory setup to operate in one of the three following modes:

- **Modulating:** 0-10 VDC signal wired in the field by others varies the speed of the blower between 30 and 60Hz
- **Multi-Speed:** Digital contact closures by others command the VFD to run at multiple speed settings:
 - Open - Drive runs at 60Hz
 - SC to S4 - Drive runs at 40Hz
 - SC to S5 - Drive runs at 30Hz
- **CO₂ Sensor:**

Set Point Control: A carbon dioxide sensor is provided from the factory for field-mounting OR unit mounting in the space(s) being served by the energy recovery unit. The CO₂ sensors are wired to the unit VFD's with two preset speeds of 700 PPM or less CO₂ = 50% fan speed and 800 PPM or greater CO₂ = 100% fan speed.

Proportional Control: A carbon dioxide sensor is provided from the factory for field-mounting OR unit mounting in the space(s) being served by the energy recovery unit. The CO₂ sensors are wired to the unit VFD's with default factory settings of 500 PPM or less CO₂ = 50% fan speed and 1000 PPM or greater CO₂ = 100% fan speed. Modulation of VFD occurs proportional to CO₂ between 500 and 1000 PPM.

The terminal locations for Modulating and Multi-speed are shown on the previous page. Most of the set points in the VFDs are Yaskawa factory defaults. However, a few set points are changed at Greenheck and are shown in the tables. These settings are based on the VFD mode selected.

Change Set Points

To gain access to change set points on the V1000 and J1000 drives, parameter A1-01 needs to be set at "2". To prevent access or tampering with drive settings on either drive, change parameter A1-01 to "0".

- **Drive Operation**
 - SC to S1 contact for On/Off
 - A1 (0-10 VDC) referenced to AC
Can use +15 VDC from +V

Resetting the V1000 drive to factory defaults

To reset the V1000 drive back to Greenheck factory defaults go to parameter A1-01 and set it to "2". Then go to A1-03 and change it to "1110" and press enter. The drive is now reset back to the settings programmed at Greenheck. This option is not available on the J1000.

Modulating Control for Fan Speed (0-10 VDC)			
Parameter		Setting	
		V1000	J1000
A1-01	Access Level	2	2
B1-17	VFD Start-Up Setting	1	1
C6-02	Carrier Frequency	1	1
D2-02	Ref Lower Limit	50%	50%
E2-01	Motor Rated FLA	Motor FLA	Motor FLA
H2-01	Terminal MA, MC Function	5	5
H3-04	Terminal A1 Bias	50%	50%
L4-01	H2-01 Frequency Detection	15	15
L5-01	Auto Restart Attempt	5	5
A1-01	Access Level	0	0

CO₂ Proportional Control			
Parameter		Setting	
		V1000	J1000
B1-17	VFD Start-Up Setting	1	1
C6-02	Carrier Frequency	1	1
D2-02	Ref Lower Limit	50%	50%
E2-01	Motor Rated FLA	FLA	FLA
H3-03	Analog Frequency Reference (Gain)	150%	150%
H3-04	Analog Frequency Reference (Bias)	25%	25%
L2-01	Ride Thru Power Loss	2	2
L4-05	Frequency Ref Loss	0	NA
L5-01	Auto Restart Attempt	5	5
A1-01	Access Level	0	0

CO₂ Sensor Control for Fan Speed (1/2 speed when CO ₂ drops below 700 PPM) (Full speed when CO ₂ rises above 800 PPM)			
Multi-Speed Control for Fan Speed (1/3 or 1/2 speed reduction)			
Parameter		Setting	
		V1000	J1000
A1-01	Access Level	2	2
B1-01	Reference Source (Frequency)	0	0
B1-17	VFD Start-Up Setting	1	1
C6-02	Carrier Frequency	1	1
D1-01	Frequency Reference 1	60 Hz	60 Hz
D1-02	Frequency Reference 2	40 Hz	40 Hz
D1-03	Frequency Reference 3	30 Hz	30 Hz
D1-04	Frequency Reference 4	60 Hz	60 Hz
D2-02	Ref Lower Limit	50%	50%
E2-01	Motor Rated FLA	Motor FLA	Motor FLA
H1-04	Multi-Function Input Sel 4 (Terminal S4)	3	3
H1-05	Multi-Function Input Sel 5 (Terminal S5)	4	4
H1-06	Multi-Function Input Sel 6 (Terminal S6)	5	NA
H2-01	Terminal MA, MC Function	5	5
H3-10	A2 Not Used	F	NA
L4-01	H2-01 Frequency Detection	15	15
L5-01	Auto Restart Attempt	5	5
A1-01	Access Level	0	0

Variable Frequency Drives for Energy Recovery Wheel			
Parameter		Setting – J1000	
A1-01	Access Level	2	
B1-17	VFD Auto Start	1	
C1-04	Decel Time	600	
*C4-01	Torque Gain	0.6	
C6-02	Carrier Frequency	2	
D2-01	Ref Upper Limit	40 or 50*	
D2-02	Ref Lower Limit	5%	
E2-01	Motor Rated FLA	Motor FLA	
E2-03	Motor No-Load Current	Must be less than FLA	
H1-02	Multi-Function Input (Terminal S2)	6	
H2-01	Multi-Function Output (MA, MB, MC)	4	
H1-04	Multi-Function Input Sel 4 (Terminal S4)	7	
Economizer Signal Source (0-10 VDC)			Setting
			Honeywell Module
			Carel Controller
H3-03	Analog Frequency Reference (Gain)	0	40 or 50*
H3-04	Analog Frequency Reference (Bias)	40 or 50**	0
L1-01	Elect Thermal Overload	2	
L2-01	Ride Thru Power Loss	2	
L4-01	Frequency Detection Level	15	
L5-01	Auto Restart Attempt	5	
A1-01	Access Level	0	

* 208/230 volt only

**36 through 52 inch wheels are 40 (24 Hz)
58 or 74 inch wheel is 50 (30 Hz)

Routine Maintenance

DANGER

Electric shock hazard. Can cause injury or death. Before attempting to perform any service or maintenance, turn the electrical power to the unit to OFF at disconnect switch(es). Unit may have multiple power supplies.

CAUTION

Use caution when removing access panels or other unit components, especially while standing on a ladder or other potentially unsteady base. Access panels and unit components can be heavy and serious injury may occur.

This unit requires minimal maintenance to operate properly. Maintenance requirements for this model vary for each installation and depend greatly on how much the system is used and the cleanliness of the air. Proper maintenance will both increase the life of the system and maintain its efficiency. Maintenance must be performed by experienced technicians and in the case of refrigeration systems, must be done by an EPA certified technician.

Maintenance frequency is based on a presumed nominal use of the system. If the system is being run constantly, the frequency should be adjusted accordingly. If there is seasonal debris in the air which can be drawn into the filters and the coils, they should be checked more frequently. If the system is being used for only a few hours per day, the frequency may be reduced. Use the maintenance log at the end of this manual to record each maintenance session and observations and then establish a maintenance schedule that is appropriate for the installation. The following is provided as a guideline:

Maintenance Frequency

Monthly

1. External Filter
Clean metal mesh filters
2. Internal Filters
Replace MERV 8 filters monthly.
Adjust replacement schedule for MERV 13 or other filters as inspection requires.

Semiannually

1. Check motor and motor bearings
Check for excessive heat, vibration or noise.
Lubricate bearings in accordance with the motor manufacturer's recommendations.
2. Condensate Drain (if applicable)
Inspect and clean – refill with water
3. Wrap-Around Heat Pipe
Inspect for cleanliness – clean as required

Annually

It is recommended that the annual inspection and maintenance occur at the start of the cooling season. After completing the checklist, follow the unit start-up checklist provided in the manual to ensure the refrigeration system operates in the intended matter.

1. Lubrication
Apply lubricant where required
2. Dampers
Check for unobstructed operation
3. Blower Wheel and Fasteners
Check for cleanliness
Check all fasteners for tightness
Check for fatigue, corrosion, wear
4. Door Seal
Check if intact and pliable
5. Wiring Connections
Check all connections for tightness
6. Cabinet
Check entire cabinet, inside and out, for dirt buildup or corrosion. Remove accumulated dirt, remove any surface corrosion and coat the area with appropriate finish.

Maintenance Procedures

WARNING

REFER TO GENERAL SAFETY INFORMATION

Do not operate this unit without the filters and birdscreen installed. They prevent the entry of foreign objects such as leaves, birds, etc. Do not remove access panels or other unit components while standing on a ladder or other unsteady base. Access panels and unit components are heavy and serious injury may occur.

Lubrication

Check all moving components for proper lubrication. Apply lubricant where required. Any components showing excessive wear should be replaced to maintain the integrity of the unit and ensure proper operation.

Dampers

Check all dampers to ensure they open and close properly and without binding. Backdraft dampers can be checked by hand to determine if blades open and close freely. Apply power to motorized dampers to ensure the actuator opens and closes the damper as designed.

Fan Belts

Belts must be checked on a regular basis for wear, tension, alignment, and dirt accumulation. Premature or frequent belt failures can be caused by improper belt tension (either too loose or too tight) or misaligned sheaves. Abnormally high belt tension or drive misalignment will cause excessive bearing loads and may result in failure of the fan and/or motor bearings. Conversely, loose belts will cause squealing on start-up, excessive belt flutter, slippage, and overheated sheaves. Both loose and tight belts can cause fan vibration.

When replacing belts on multiple groove drives, all belts should be changed to provide uniform drive loading. Do not pry belts on or off the sheave. Loosen belt tension until belts can be removed by simply lifting the belts off the sheaves. After replacing belts, ensure that slack in each belt is on the same side of the drive. Belt dressing should never be used.

Do not install new belts on worn sheaves. If the sheaves have grooves worn in them, they must be replaced before new belts are installed.

The proper belt setting is the lowest tension at which the belts will not slip under peak load operation.

For initial tensioning, set the belt deflection at 1/64-inch for each inch of belt span (measured half-way between sheave centers). For example, if the belt span is 64 inches, the belt deflection should be one inch (using moderate thumb pressure at mid-point of the drive). Check belt tension two times during the first 24 hours of operation and periodically thereafter.

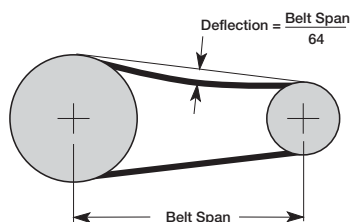

Fan Motors

Motor maintenance is generally limited to cleaning and lubrication. Cleaning should be limited to exterior surfaces only. Removing dust and grease buildup on the motor housing assists proper cooling. Never wash-down the motor with high pressure spray. Greasing of motors is only intended when fittings are provided. Fan motors typically have two grease fittings. Each motor manufacturer has different lubrication schedules for different models. Go to the motor manufacturer's website and download their maintenance requirements. Do not over-lubricate motors or use an incompatible grease. Many fractional motors are permanently lubricated for life and require no further lubrication.

Fan Wheel and Fasteners

Wheels require very little attention when moving clean air. Occasionally oil and dust may accumulate on the wheel causing imbalance. When this occurs, the wheel and housing should be cleaned to assure smooth and safe operation. Inspect fan impeller and housing for fatigue, corrosion, or wear.

Routinely check all fasteners, set screws and locking collars on the fan, bearings, drive, motor base and accessories for tightness. A proper maintenance program will help preserve the performance and reliability designed into the fan.

Bearings

Most bearings are permanently lubricated and require no further lubrication under normal use. Normal use being considered -20° to 120°F and in a relatively clean environment. Some bearings are relubricatable and will need to be regreased depending on fan use. Check your bearings for grease zerk fittings to find out what type of bearing you have. If your fan is not being operated under normal use, bearings should be checked monthly for lubrication.

Shaft bearings are the most critical moving part of a fan. Therefore, special attention should be given to keeping the bearings clean and well lubricated. Proper lubrication provides for reduction in friction and wear, transmission and dissipation of heat, extended bearing life and prevention of rust.

In order for a lubricant to fulfill these tasks, the proper grease applied at regular intervals is required.

If unusual conditions exist—temperatures below 32°F or above 200°F, moisture or contaminants—more frequent lubrication is required.

With the unit running, add grease very slowly with a manual grease gun until a slight bead of grease forms at the seal.

Be careful not to unseat the seal by over lubricating or using excessive pressure. A guide to the amount of grease to be used is to fill 30% to 60% of available space in the bearing and housing.

A high quality lithium based grease conforming to NLGI Grade 2 consistency should be used.

Internal Filter

The unit will typically be provided with 2-inch thick pleated paper filters in the airstream. These filters should be checked according to a routine maintenance schedule and replaced as necessary to ensure proper airflow through the unit. Replacement filters shall be of same performance and quality as factory-installed filters.

Filters upstream of the coil should be checked regularly. If the filters are dirty, they should be cleaned or replaced. It is important the filters stay clean to maintain desired airflow.

Internal Filter Size and Quantities			
Model	Filter Size (inches)	Quantity Supply	Quantity Exhaust
ERT-45	20 x 25	3	3
ERT-55	16 x 20	6	6
ERT-90	20 x 20	8	8

External Filter

Aluminum mesh, 2-inch thick filters are located in the supply weatherhood (if the weatherhood option was purchased). These filters should be checked and cleaned on a regular basis for best efficiency. The frequency of cleaning depends upon the cleanliness of the incoming air. These filters should be cleaned by rinsing with a mild detergent in warm water prior to start-up.

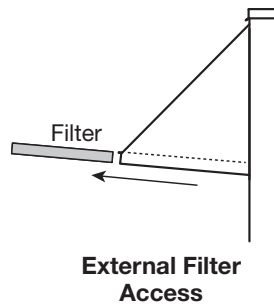

External Filter Size and Quantities		
Model	Filter Size (inches)	Quantity
ERT-45	16 x 20	4
ERT-55	16 x 20	6
ERT-90	16 x 20	8

Coils

Coils must be cleaned to maintain maximum performance. Check coils once per year under normal operating conditions and if dirty, brush or vacuum clean. Soiled fins reduce the capacity of the coil, demand more energy from the fan and create an environment for odor and bacteria to grow and spread through the conditioned zone.

For coils with fragile fins or high fin density, foaming chemical sprays and washes are available. Care must be taken not to damage the coils, including the fins, while cleaning. **Caution: Fin edges are sharp!**

WARNING

Biological hazard. May cause disease. Cleaning should be performed by qualified personnel only.

Drain pans in any air conditioning unit will have some moisture in them, therefore, algae and other organisms will grow due to airborne spores and bacteria. Periodic cleaning is necessary to prevent this buildup from plugging the drain and causing the drain pan to overflow. Inspect twice a year to avoid the possibility of overflow. Also, drain pans should be kept clean to prevent the spread of disease.

Winterizing Coils

Coil freeze-up can be caused by such things as air stratification and failure of outdoor air dampers and/or preheat coils. Routine draining of water cooling coils for winter shutdown cannot be depended upon as insurance against freeze-up. Severe coil damage may result. It is recommended that all coils be drained as thoroughly as possible and then treated in the following manner.

WARNING

Carefully read instructions for mixing antifreeze solution used. Some products will have a higher freezing point in their natural state than when mixed with water.

Fill each coil independently with an antifreeze solution using a small circulating pump and again thoroughly drain. Check freezing point of antifreeze before proceeding to next coil. Due to a small amount of water always remaining in each coil, there will be diluting effect. The small amount of antifreeze solution remaining in the coil must always be concentrated enough to prevent freeze-up.

Door Seals

An EPDM foam rubber bulb seal backed with a high strength acrylic adhesive is installed on the door frame of the unit. This creates an air tight seal between the rubber seal and the door. Inspect at least annually to ensure that the seal is damage free and still intact.

Energy Wheel Maintenance

WARNING

Whenever performing maintenance or inspections, always disconnect the power source.

Inspection

The wheel should be inspected semiannually in accordance with the maintenance schedule.

Maintenance of the wheel consists mainly of inspecting the wheel for cleanliness and then checking the drive motor, belt, and pulley for wear. If the wheel layers appear dirty, the wheel should be disassembled and cleaned.

The wheel rotates through the two airstreams which are moving in opposite directions, the wheel is self-cleaning, up to a point. If the wheel media becomes blocked by dirt or dust, or if the media collects a layer of smoke residue or an oily film, the energy transfer efficiency drops.

The main factor in the frequency of cleaning is the cleanliness of the air. If air filters are not changed frequently, the wheel will collect contaminants and will then have to be cleaned.

Wheel Disassembly

Wheels are part of a cassette that may be pulled from the unit for easy access. There may be a small damper assembly or other component that blocks removal of the cassette. Before sliding out the cassette or any other component, disconnect any power supply cord and secure it so it cannot jam or otherwise get damaged.

Each wheel has removable segments that hold the coated layers of media and each segment is held in place with two retaining clips located on the outer rim of the wheel. When removing more than one segment, remove them in sequence from opposite sides of the wheel (180 degrees apart) to reduce the imbalance. Secure the wheel against rotation. Carefully release the two retaining clips and swing them fully open. The segment can now be removed by pushing the face of the segment close to the outer rim of the wheel. Wheel segments are built to close tolerances and the segment may have to be jiggled to remove it. Do not use a hammer or otherwise force the segment because these are high value items and are not built to withstand abuse.

Whenever retaining clips are opened, they should be closed as soon as possible. If the wheel should rotate when a clip is open, the clip will jam against the bearing support bar and could cause damage.



Energy Wheel Cassette



Segment Retaining Clip

Cleaning

Maintenance or cleaning of the wheel segments should be done with the segments removed from the wheel cassette to avoid splashing liquids or cleaning agents inside the cabinet. If the energy wheel appears excessively dirty, it should be cleaned to ensure maximum operating efficiency. Only excessive buildup of foreign materials needs to be removed.

DISCOLORATION AND STAINING OF ENERGY RECOVERY WHEEL DOES NOT AFFECT ITS PERFORMANCE.

Thoroughly spray the wheel matrix with a household cleaner such as Fantastik™ or the equivalent. Gently rinse with warm water and use a soft brush to remove any heavy accumulations. A detergent/water solution can also be used. Avoid aggressive organic solvents, such as acetone. Wheel segments can be soaked in the above solution overnight for removal of stubborn dirt or accumulations.

After cleaning is complete, shake excess water from the wheel or segments. Dry the wheel or segments before putting them back into the cassette.

Reassembly

When reinstalling the segments, be sure to install them with the correct face toward the motor side of the cassette. Note that one face of each segment is smooth and the other face has a reinforcing channel or support cut into the surface.

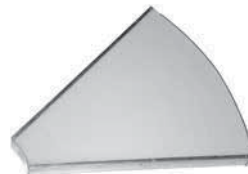

Wheel Segment (Pulley Side)



Wheel Segment (Motor Side)

Wheel Belt

Inspect belts each time filters are replaced. Belts that look chewed up or are leaving belt dust near the motor pulley may indicate a problem with the wheel. Be sure to inspect wheel for smooth and unrestricted rotation. If a belt requires replacement, contact the local manufacturer representative. Instructions for replacement will ship with the new belt.

Wheel Bearing

In the unlikely event that a wheel bearing fails, the bearing is behind a removable plate on the wheel support beam (slide cassette halfway out of cabinet to access). Contact the local manufacturer representative for detailed instructions on how to replace the bearing.

Troubleshooting – Unit

Symptom	Possible Cause	Corrective Action
Blower fails to operate	Blown fuse or open circuit breaker.	Replace fuse or reset circuit breaker and check amps.
	Defective motor or capacitor.	Replace.
	Motor overloaded.	Reset VFD and check amps.
	Electrical.	Check for On/Off switches. Check for correct supply voltage. Check Control wiring.
Motor starters “chatter” or do not pull in	Control power (24 VAC) wiring run is too long. (Resistance should not exceed 0.75 ohms).	Shorten wiring run to mechanical room or install a relay to turn unit on/off. Consult factory for relay information. Increase wire gauge size so that resistance is 0.75 ohms or less.
	Incoming supply power is less than anticipated. Voltage supplied to starter coil must be within +10% / -15% of nominal voltage stated on the coil.	Need to increase supply power or use a special control transformer which is sized for the actual supply power.
Motor over amps	Static pressures are higher than design.	Check for dirty filters. Improve ductwork.
	Motor voltage incorrect.	Check motor wiring. Check motor nameplate versus supplied voltage.
	Motor horsepower too low.	See specifications and catalog for fan curves to determine if horsepower is sufficient.
	Shorted windings in motor.	Replace motor.
Low airflow (cfm)	Unit damper not fully open.	Adjust damper linkage or replace damper motor.
	System static pressure too high.	Improve ductwork to eliminate losses using good duct practices.
	Blower speed too low.	Check maximum motor RPM and compare with catalog data. Verify that external control wiring is in place if required.
	Fan wheels are operating backwards.	For 3-phase, see Direction of Fan Wheel Rotation in Start-Up Components section.
	Dirty filter.	Replace filters or follow cleaning procedures in Routine Maintenance section of this manual.
	Leaks in ductwork.	Repair.
	Elbows or other obstructions may be obstructing fan outlet.	Correct or improve ductwork.
High airflow (cfm)	Blower fan speed too high.	Check for correct maximum fan RPM. Decrease maximum fan speed if necessary in the VFD.
	Filter(s) not in place.	Install filters.
	Insufficient static pressure (Ps). (airflow resistance)	Induce Ps into system ductwork. Make sure grilles and access doors are installed. Decrease fan speed if necessary.
Excessive noise or vibration	Fan wheel rubbing on inlet.	Adjust wheel and/or inlet cone. Tighten wheel hub or bearing collars on shaft.
	Bearings.	Replace defective bearing(s). Lubricate bearings. Tighten collars and fasteners.
	Loose wheel on shaft.	Tighten wheel hub.
	Motor base or blower loose.	Tighten mounting bolts.
	Noise being transmitted by duct.	Make sure ductwork is supported properly. Make sure ductwork metal thickness is sized for proper stiffness. Check duct size at discharge to ensure that air velocities are not too high.

Always have a completed Pre-Start-Up Checklist and Start-Up Checklist prior to requesting parts or service information.

Troubleshooting - Energy Wheel

Symptom	Possible Cause	Corrective Action
Energy wheel does NOT turn	Air seals are too tight.	See Air Seals in the Start-Up Components, Energy Wheel section.
	Broken belt.	Replace.
	No power to wheel motor.	Make sure wheel drive is plugged in. Verify power is available.
Energy wheel runs intermittently	Wheel motor overloads are tripping due to rubbing between wheel and air seals.	Recheck air seals, make sure they are not too tight. See Adjust the Air Seals in the Start-Up Components, Energy Wheel section.

Troubleshooting - Controller Alarms

The first step in troubleshooting the unit is to check the on-board alarm indicators. Several of the electronic controls in the unit monitor the system for faults and will go into alarm, shutting down the unit or a single function within the unit.

Microprocessor Controller

Check the screen on the microprocessor for an alarm condition. If it is in alarm condition, a message will show on the screen.



The microprocessor controller is located in the main control center. If it is in alarm condition, the alarm button will blink red. Press the alarm button to see the specific condition or to reset the microprocessor. Refer to the DDC Installation Operations and Maintenance manual for detailed information on fault codes and see the unit-specific wiring diagram.

Variable Frequency Drive (VFD)

VFDs have a display screen that will show an alarm condition. If a fault such as a voltage spike occurs, the VFD will go into alarm and will not reset until a hard restart is performed. See the unit-specific manufacturer's manual supplied with the unit. VFDs are located in the main control center.



Troubleshooting - Rotation Sensor

When the unit is first turned on, the LED on the back of the sensor should turn on and stay on with the wheel running.

1. When the wheel is spinning, the contact in the rotation sensor is closed and the small LED light on the sensor is ON.
2. When the wheel is stopped, there is a 10-20 second delay before the sensor will indicate no rotation. When the sensor indicates no rotation, it opens the internal contact and the LED light is OFF.
3. If the LED comes on and then shuts off after 5 seconds or less, the sensor is NOT properly set. **Contact manufacturer for adjustment procedure.**
4. If the LED comes on and then shuts off after 10-20 seconds, the sensor is properly set although it is either too close to the wheel or not close enough. It should be 4 mm from the wheel. Verify that the sensor depth was set using the appropriate gauge.

When the wheel is unplugged and the unit is still powered on:

1. The LED should stay on for 10-20 seconds and then turn off.

Troubleshooting - Economizer Alarms

Addressing Alarms

Alarms will signify a faulty sensor. When this occurs, verify all connections to the sensor and controller are secure. Press enter twice to clear the alarm. If the issue persists, consult the factory.

Clearing Alarms

Once the alarm has been identified and the cause has been removed (e.g. replaced faulty sensor), the alarm can be cleared from the display.

To clear an alarm, perform the following:

1. Navigate to the desired alarm.
2. Press the \blacktriangleleft (enter).
3. ERASE? displays.
4. Press \blacktriangleleft (enter).
5. ALARM ERASED displays.
6. Press \ominus (escape) to complete the action and return to the previous menu.

NOTE

If an alarm still exists after you clear it, it redisplay within 5 seconds.

Maintenance Log

Date _____ Time _____ AM/PM

Notes: _____

Date _____ Time _____ AM/PM

Notes: _____

Date _____ Time _____ AM/PM

Notes: _____

Date _____ Time _____ AM/PM

Notes: _____

Date _____ Time _____ AM/PM

Notes: _____

Date _____ Time _____ AM/PM

Notes: _____

Date _____ Time _____ AM/PM

Notes: _____

Date _____ Time _____ AM/PM

Notes: _____

Date _____ Time _____ AM/PM

Notes: _____

Date _____ Time _____ AM/PM

Notes: _____

Date _____ Time _____ AM/PM

Notes: _____

Date _____ Time _____ AM/PM

Notes: _____



Maintenance Log

Date _____ Time _____ AM/PM

Notes: _____

Date _____ Time _____ AM/PM

Notes: _____

Date _____ Time _____ AM/PM

Notes: _____

Date _____ Time _____ AM/PM

Notes: _____

Date _____ Time _____ AM/PM

Notes: _____

Date _____ Time _____ AM/PM

Notes: _____

Date _____ Time _____ AM/PM

Notes: _____

Date _____ Time _____ AM/PM

Notes: _____

Date _____ Time _____ AM/PM

Notes: _____

Date _____ Time _____ AM/PM

Notes: _____

Date _____ Time _____ AM/PM

Notes: _____

Date _____ Time _____ AM/PM

Notes: _____



Our Commitment

As a result of our commitment to continuous improvement, Greenheck reserves the right to change specifications without notice.

Specific Greenheck product warranties are located on greenheck.com within the product area tabs and in the Library under Warranties.

Greenheck catalog Energy Recovery Ventilator Model ERT, provides additional information describing the equipment, fan performance, available accessories, and specification data.

AMCA Publication 410-96, Safety Practices for Users and Installers of Industrial and Commercial Fans, provides additional safety information. This publication can be obtained from AMCA International, Inc. at: www.amca.org.

