

Application

The WD-200 series are electrically motorized backdraft dampers that open when energized and spring return close when de-energized. The WD-200 series are for horizontal or vertical mounting. Primary application is to prevent undesirable reverse airflow when installed with roof or sidewall supply (intake) fans. Electric motor pack is shipped separately and requires installation in the field.

Ratings

Pressure

1.0 in. wg (0.25 kPa) - differential pressure

Velocity

2500 fpm (13 m/s)

Temperature

180°F (82°C)

Construction

	Standard
Frame Material	Galvanized steel
Frame Thickness	18 ga. (1.3mm)
Frame Type	No flange (WD-200)
	Flange on motor side (WD-210)
	Flange opposite motor side (WD-220)
Blade Material	Roll formed aluminum
Blade Thickness	0.032 in. (0.8mm) - 0.04 in. (1mm)
Blade Seals	Vinyl
Axle	$\frac{3}{16}$ in. (4.8mm) dia. zinc plated steel pin on blade ends
Axle Bearings	Synthetic
Linkage Material	Galvanized steel
Operator	MP-200 series motor pack(s)

Size Limitations

W x H	Minimum Size	Maximum Size	
		Single Panel	Multiple Panels
WD-210 & WD-220			
Inches	6 x 6	31 x 74	148 x 148
mm	152 x 152	787 x 1880	3759 x 3759
WD-200			
Inches	6 x 6	31 x 74	150 x 148
mm	152 x 152	787 x 1880	3810 x 3759

Options

- End Switch Kit (part no. 851038)



*W & H dimensions furnished approximately $\frac{1}{8}$ in. (3mm) undersize.

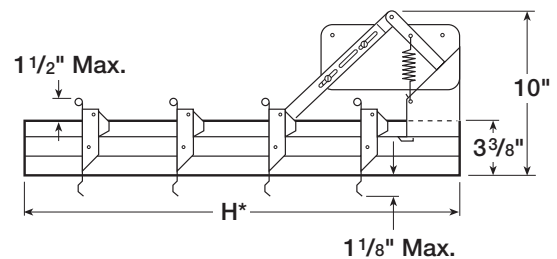

Model WD-200
No Flange

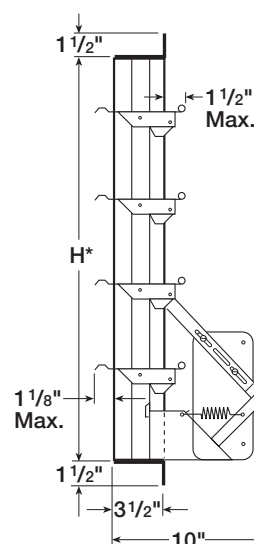

Model WD-210
Flange on Motor Side

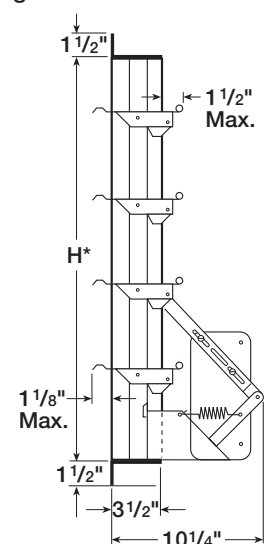

Model WD-220
Flange Opposite Motor

Performance Data

Pressure Drop

Performance data results from testing a 36 in. x 36 in. (914mm x 914mm) damper in accordance with AMCA Standard 500-D using Figure 5.5 (unducted). All data has been corrected to represent standard air at 0.075 lb/ft³ (1.201 kg/m³).

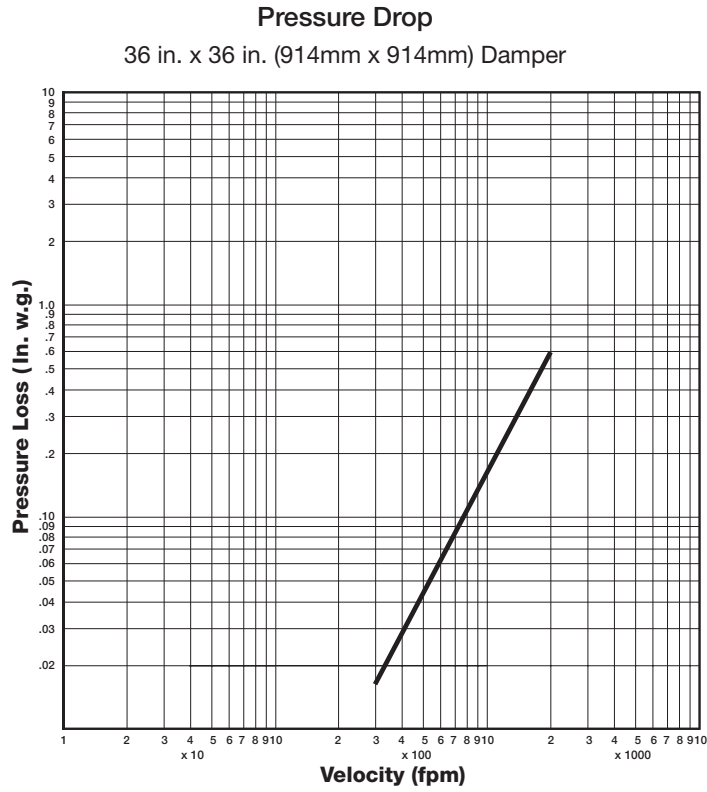

Leakage

Leakage testing was conducted in accordance with AMCA Standard 500-D and is expressed as CFM per sq. ft. of damper face area. All data has been corrected to represent standard air at 0.075 lb/ft³ (1.201 kg/m³).

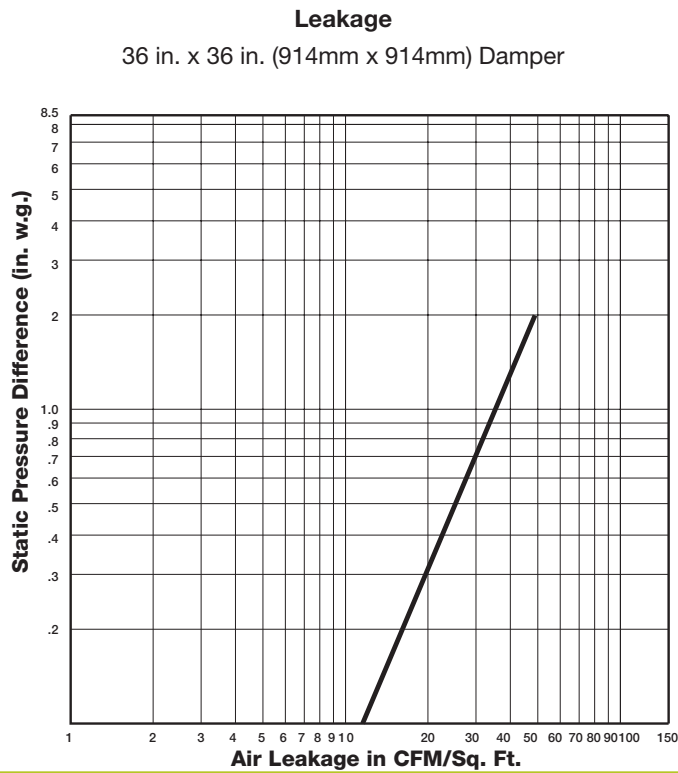

Motor Packs

Series MP-210 and MP-220A is a standard feature of all WD-200 dampers. These motor packs are field installed to convert the WD-200 series backdraft damper to motorized operation. Airflow direction can be vertical or horizontal. These versatile motor packs feature power opening with spring return. The springs also provide damper closure in the event of electrical failure.

The MP-210 and MP-220A motor packs are available in voltages of 24, 120, 208, 220, and 440. The 575/600 volts may be used for the MP-200 series by way of a transformer (part no. 380711) and the appropriate 115 volt motor pack (MP-210 or MP-220A). All MP-200 series motor packs are UL listed. Specify voltage when ordering.

There are two motor packs available on the WD-200 series damper to accommodate for larger torque requirements. To determine the type and number of motor packs required on WD-200 damper, refer to the table on page 5. To determine the type and number of motor packs required per WD-210 or WD-220 damper, refer to the table on page 7. Oversized applications may require several dampers connected together for one opening.

MP-200 series motor packs are supplied with mounting hardware, assembly instructions and actuator arms for either single, double, or triple panel installation.

MP-210/220A Motor packs	24V (50/60 Hz)	110V-120V (50/60Hz)	208V - 240V (50/60Hz)	460V (60Hz)
Stall Amps	.66	.15	.07	.041
Spec ID#	G24	G110-240	G110-240	G460



[MP-210 INSTALLATION](#)



[MP-220A INSTALLATION](#)

Motor Pack Dimensional Data

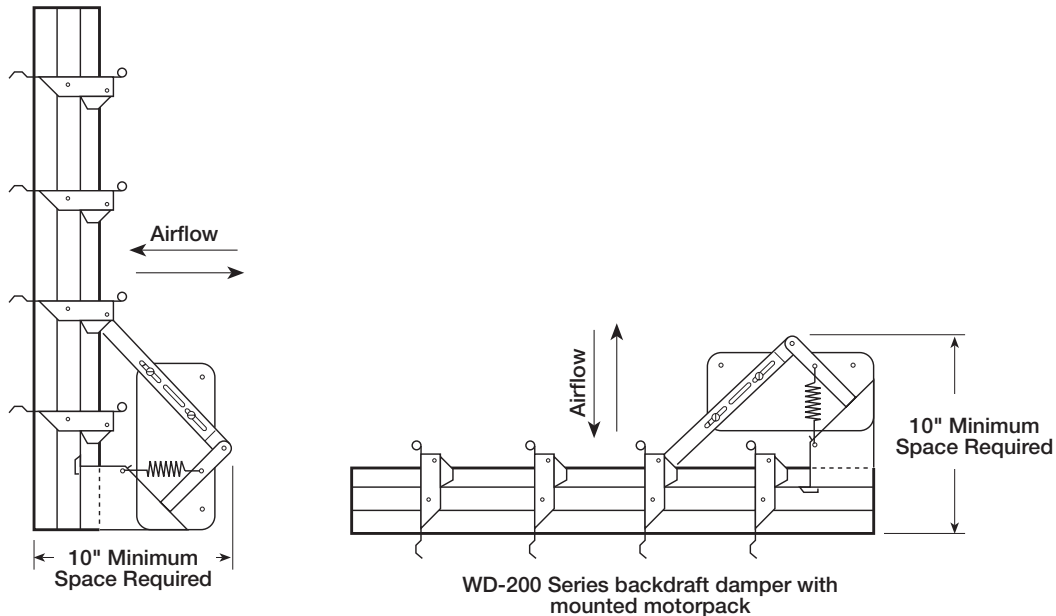





































WD-200 series dampers come standard with a motor pack. The diagrams above illustrate the required clearance needed for proper operation of a mounted motor pack.

WD-200 Selection

Multiple section dampers shown below are supplied as equal size sections. Any damper that has multiple sections, both vertically and horizontally, will require field assembly and will require additional reinforcement (not supplied by factory) to support the assembly. These larger dampers must have the additional reinforcement to give them structural stability.

The width dimension is always parallel to the length of the blades.

Note: The type and number of motor packs required can be found on page 6.

		Width						
		6	32	50	64	100	128	150
Height	6	6 Up To 32	32 Up Thru 50	Above 50 Up to 64	64 Up Thru 100	Above 100 Up To 128	128 Up To 150	
	6 Up Thru 74	Single Panel One Section 	Double Panel One Section 	Single Panel Two Section  	Double Panel Two Section  	Single Panel Four Section    	Double Panel Three Section   	
	74	Above 74 Thru 148	Single Panel Two Section  	Double Panel Two Section  	Single Panel Four Section    	Double Panel Four Section    	Single Panel Eight Section       	Double Panel Six Section     
	148							

*Width and height given in inches.

Motor Pack Selection for WD-200

The table below will allow you to determine the type and number of motor packs needed for a given size WD-200 backdraft damper. For further information on a particular motor pack, refer to page 3.

		Width				
		6	37	50	100	128
Height	6	≥ 6 and < 37	≥ 37 and ≤ 50	> 50 and ≤ 100	> 100 and < 128	≥ 128 and ≤ 150
	≥ 6 and ≤ 74	1 MP-210 Motor Pack	1 MP-220A Motor Pack	2 MP-220A Motor Packs	4 MP-220A Motor Packs	3 MP-220A Motor Packs
	74					
	> 74 and ≤ 148	2 MP-210 Motor Packs	2 MP-220A Motor Pack	4 MP-220A Motor Packs	8 MP-220A Motor Packs	6 MP-220A Motor Packs
	148					









*Width and height given in inches.

WD-210/220 Selection

Multiple section dampers shown below are supplied as equal size sections. Any damper that has multiple sections, both vertically and horizontally, will require field assembly and will require additional reinforcement (not supplied by factory) to support the assembly. These larger dampers must have the additional reinforcement to give them structural stability.

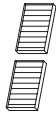
The width dimension is always parallel to the length of the blades.

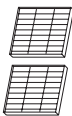
Note: The type and number of motor packs required can be found on page 6.

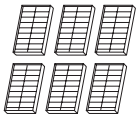
		Width					
		6	32	64	74	128	148
		6 Up To 32	32 Up To 64	64 Up Thru 74	Above 74 Up To 128	128 Up Thru 148	
Height	6 Up Thru 74	Single Panel One Section 	Double Panel One Section 	Triple Panel One Section 	Double Panel Two Section 	Double Panel Three Section 	
	Above 74 Thru 148	Single Panel Two Section 	Double Panel Two Section 	Triple Panel Two Section 	Double Panel Four Section 	Double Panel Six Section 	
	6						
	74						
	148						

*Width and height given in inches.

Motor Pack Selection for WD-210/220

The table below will allow you to determine the type and number of motor packs needed for a given size WD-200 backdraft damper. For further information on a particular motor pack, refer to page 3.

		Width				
		6	37	64	128	148
Height	6	>=6 and <37	>=37 and <64	>=64 and <128	>=128 and <=148	
	>=6 and <=74	1 MP-210 Motor Pack	1 MP-220A Motor Pack	2 MP-220A Motor Packs	3 MP-220A Motor Packs	
	74	>=74 and <=148				
	>=74 and <=148	2 MP-210 Motor Packs	2 MP-220A Motor Pack	4 MP-220A Motor Packs	6 MP-220A Motor Packs	
	148					

*Width and height given in inches.

An end switch is a control device used in conjunction with a motor pack (the end switch is usually wired to a fan and/or to a light serving as an open/not open indicator). When the damper is powered open, the blades of the damper hit the spring rod of the end switch which in turn makes a connection allowing power to flow to the fan and/or light. This set up would be used when it is desirable to ensure that the damper is fully open before the fan starts. Otherwise, with the damper blades are not fully open, the pressure and air velocity produced by the fan may damage the blades, making the damper inoperable.

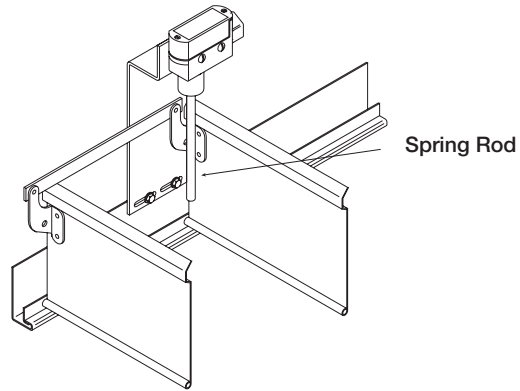

Horizontally Mounted Damper



[INSTALLATION](#)

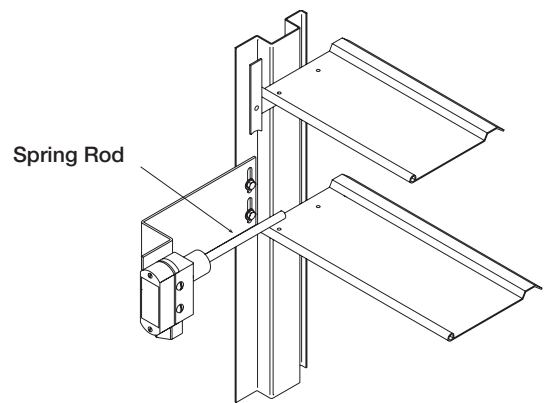

Vertically Mounted Damper

Document Links



[CATALOG](#)



[SELECTION GUIDE](#)



[WARRANTY](#)

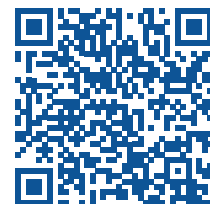

[SPECIFICATIONS](#)