

# Plenum Fans

Models APD, APM, APH and HPA

Belt and Direct Drive

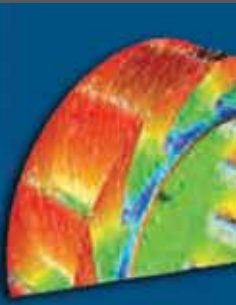

November  
2019

# Quiet & Efficient Plenum Fans

Plenum fans are designed and engineered to provide superior performance and reliability in commercial or industrial applications. Our products are manufactured with state-of-the-art laser, forming, spinning and welding equipment, and endure our quality control testing to ensure trouble free start-up. They are designed for unhooused operation, resulting in a savings of the space normally occupied by the fan housing. Additional space savings are realized when multiple duct takeoffs are required. Ductwork is connected directly to the pressurized plenum without intermediate transitions.

## Typical applications include:

- Custom air handlers
- Built-up air handlers
- Packaged air handlers
- Parking garages
- General supply and return systems



Greenheck Fan Corporation certifies that the model APD, APM, APH and HPA plenum fans shown herein are licensed to bear the AMCA seal. The ratings shown are based on tests and procedures performed in accordance with AMCA Publication 211 and Publication 311 and comply with the requirements of the AMCA Certified Ratings Program.

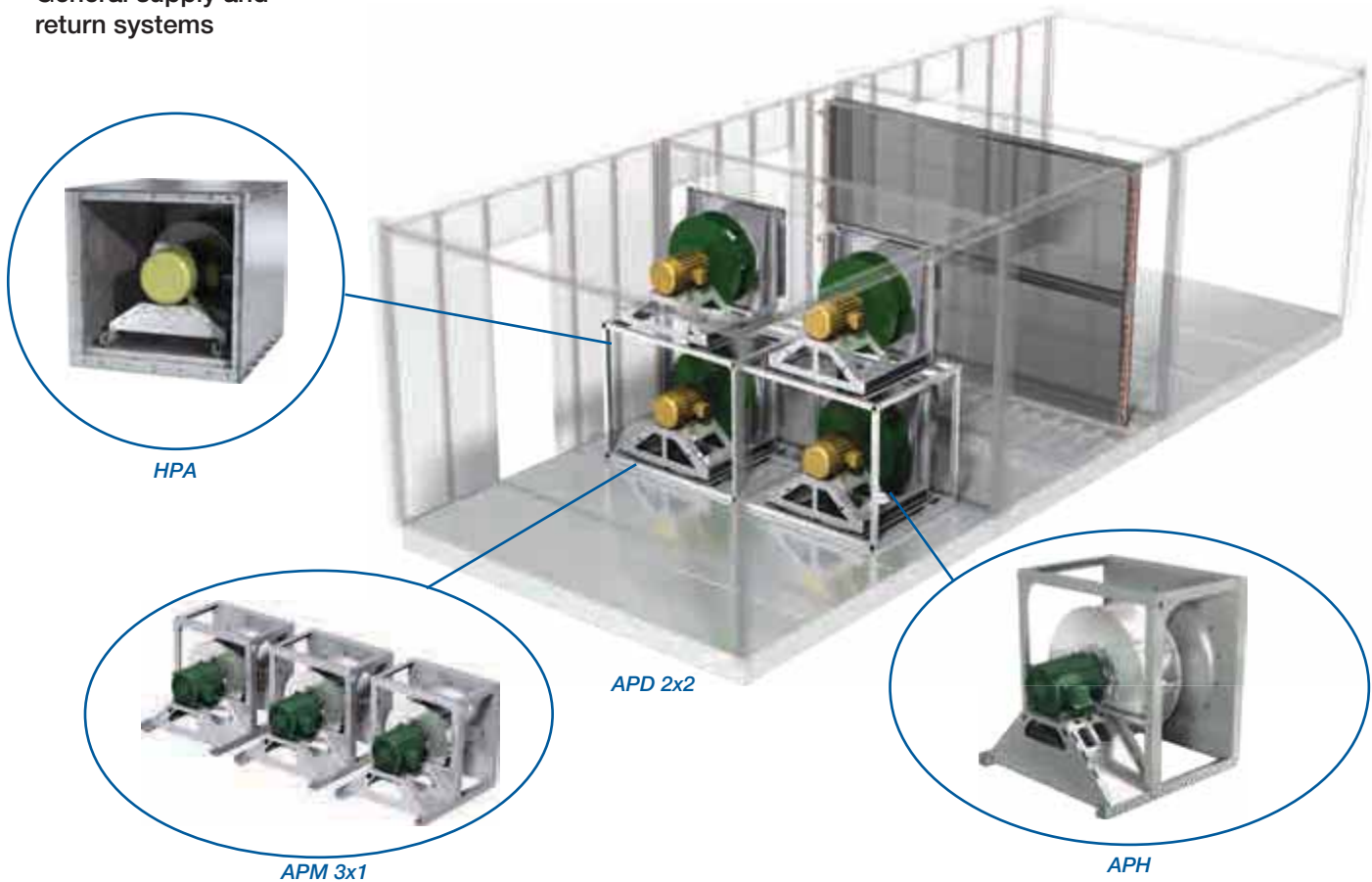

## Manufactured in the USA

Greenheck plenum fans are designed and built in one of two manufacturing locations, Schofield, WI and Shelby, NC. Multiple manufacturing locations enables us to build fans and get them to you, our customer, faster.

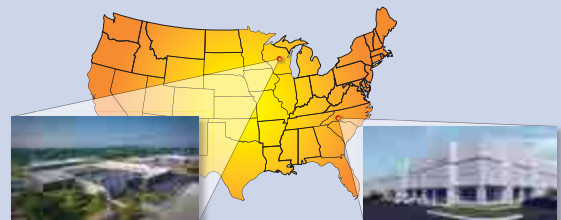

## Benefits of Greenheck's plenum fans

- Designed, engineered, and tested prior to shipment to provide years of smooth, vibration-free operation with minimal maintenance.
- Tiered model approach gives you flexibility in size, performance, and construction, matching the appropriate model to your application.
- 7- or 12-bladed wheel options allow you to select a model based on what is important to you. Plenum fans can be selected based on performance, efficiency or price point.
- Quick and easy selection options along with AutoCAD® and Revit® models available for download and integration into plan drawings, custom equipment schedules and specifications.
- CAPS® selection software leads the industry in providing selection details, options, accessories, and full submittal packages. Or use eCAPS®, an easy-to-use cloud based cross-model selection program. eCAPS quickly ranks the tiered models based on performance, providing detailed estimated first cost, operating costs, weights, and dimensions. All fans are selectable with N-1 redundancy.
- Easy installation with integral lifting points.

## Wheel Performance - 7 Blades vs. 12 Blades

Performance Point: 5,000 cfm @ 5 in. wg						Sound Pressure dBA @ 5 ft.		Performance Point: 10,000 cfm @ 3 in. wg						Sound Pressure dBA @ 5 ft.	
Size	Blades on Wheel	rpm	bhp	Motor Size	Static Eff. (%)	Inlet	Outlet	Size	Blades on Wheel	rpm	bhp	Motor Size	Static Eff. (%)	Inlet	Outlet
APD-400 (15.8 in.)	7	3170	5.79	7.5	68	80	85	APD-630 (24.8 in.)	7	1539	6.82	7.5	69	77	86
APH-16	12	2875	5.79	7.5	68	77	82	APH-24	12	1542	6.77	7.5	70	76	81

### Motor on Base



\*Available on base by Greenheck or by others



\*Available on base by Greenheck or by others



### Motor on Frame

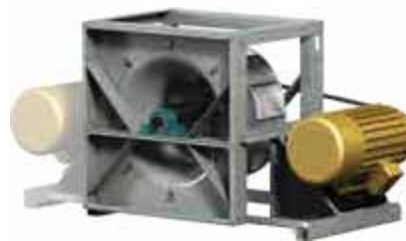

## Multiple solutions for your plenum design needs.

The **APD** is a commercial grade plenum fan that incorporates performance and reliability into a lighter duty, economical design. The compact direct drive APD eliminates the cost, maintenance and complexity of belt drive plenum fans. When combined with a variable frequency drive (VFD), air volumes can easily be matched to changing building requirements or overcome increased pressures from dirty filters. APDs are an excellent option as a stand-alone single fan or in parallel fan array applications.

- 1,000 - 18,000 cfm, up to 10 in. wg
- Bolted galvanized frame
- 7-bladed backward curved wheel
- Ideal for light to medium duty applications
- Direct drive



**APM** plenum fans are an ideal cost-effective solution for light duty to mid-range performances required in Class I and the majority of Class II ranges. Fans are available in both belt and direct drive designs having the motor mounted directly to the fan to reduce the fan's footprint. This is an excellent selection for retrofit and replacement applications and in variable air volume systems.

- 1,000 - 41,000 cfm, up to 8 in. wg
- Bolted galvanized or coated steel frame
- 12-bladed aluminum airfoil wheel
- Class I and most of Class II performance ranges
- Belt and direct drive



**APH** plenum fans are designed and engineered for superior performance and reliability. It is available in both belt and direct drive with an extensive accessory offering. Quiet and efficient operation is achieved through a 12-bladed, airfoil aluminum wheel. Model APH is ideal for industrial applications that require welded construction, coated framework. Available in multiple configurations and the highest performance capabilities.

- 1,000 - 209,000 cfm, up to 12.5 in. wg
- Welded and coated steel frame
- 12-bladed aluminum airfoil wheel
- Available up to Class III
- Belt and direct drive



**HPA** housed plenum fans are designed and engineered to provide superior performance and reliability in commercial or industrial applications. The HPA can be used as a single fan in a sound critical application or in parallel to construct a fan array system. The HPA features a modular design with a structural housing that allows multiple modules to stack side-by-side and on top of one another to form an array.

- 900 - 45,000 cfm, up to 7 in. wg
- Bolted galvanized frame
- 12-bladed aluminum airfoil wheel
- Direct drive





Charts show performance capabilities by model and size. For complete AMCA licensed performance, refer to Greenheck's CAPS or eCAPS selection programs.

## APD Performance

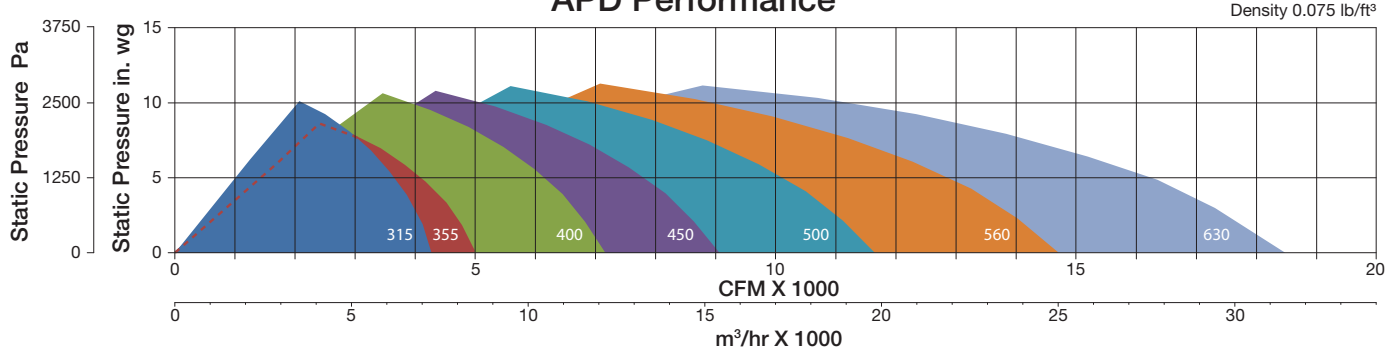

## APM Performance

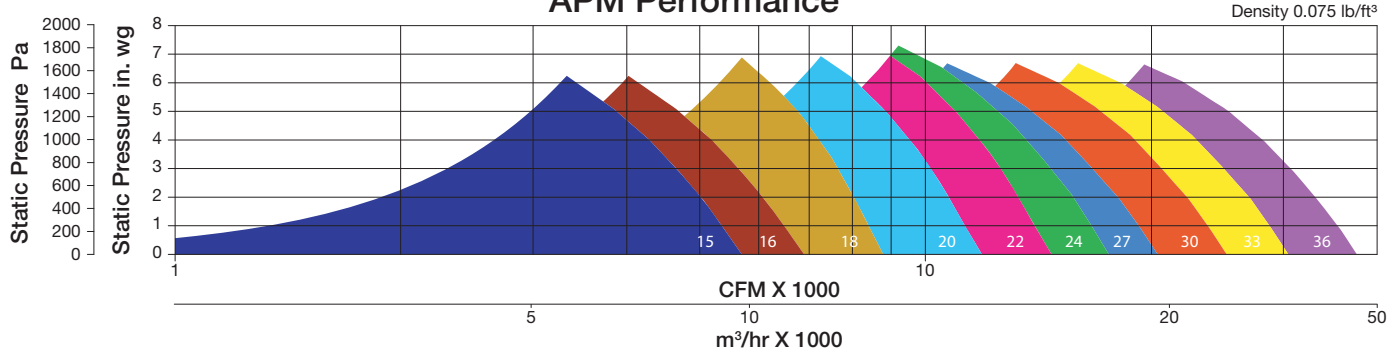

## APH Performance

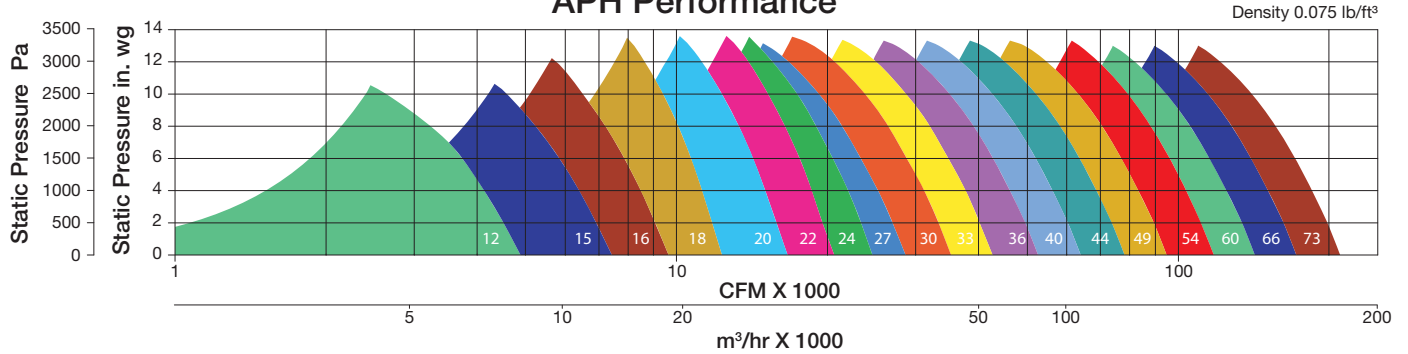

## HPA Performance

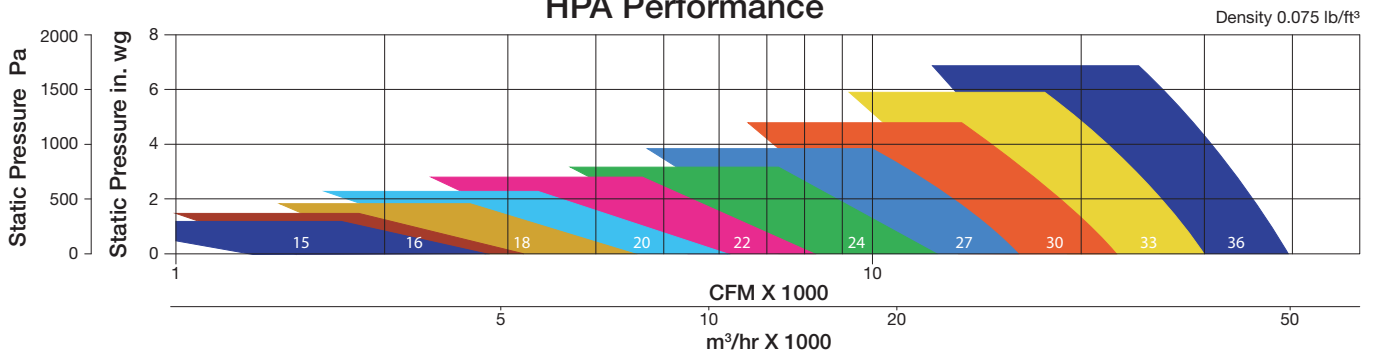

## Sound Attenuating Housing (HPA)

The fan assembly is mounted inside a sound attenuating housing. The housing has a perforated galvanized inner liner that directs sound waves into two inches of sound absorbing fiberglass between the inner liner and the solid outer shell. The result is a reduction of sound levels.

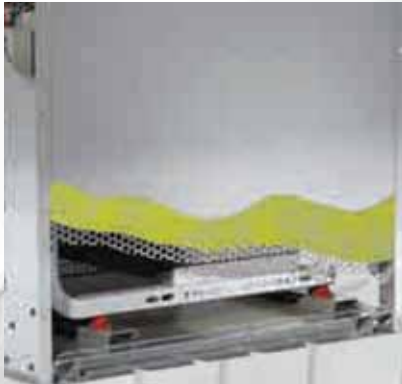

## Internal Vibration Isolation (HPA)

Neoprene isolators mounted between the fan assembly and the sound attenuating housing reduce vibration, eliminating the need for isolators and gaskets between modules. Flexible gasket material between the inlet cone and sound attenuating housing creates an airtight seal.

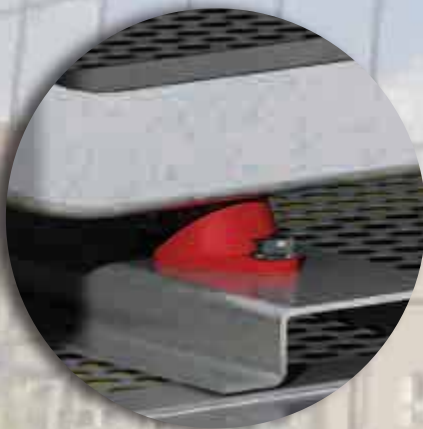

## Housing Options (HPA)

Three different sound attenuating housing sizes makes sizing the HPA extremely flexible. The standard housing is sized for optimum performance versus footprint. The compact housing offers a smaller footprint for applications with space constraints and the large housing offers increased air performance for higher efficiencies.

## Construction - Galvanized (APD, APM, HPA)

The fan assembly and sound attenuating housing are constructed of laser cut and die-formed heavy-gauge galvanized material.



## Construction - Coated Steel (APM, APH)

Fully welded design with Permator™, an electrostatically applied polyester urethane powder coat finish.



## Drives

All plenums are available with a direct drive fan. There are no belts to tension, sheaves to replace, or fan bearings lubricate. Lubricating the motor bearings is the only maintenance required.

APM and APH are available in belt drive configurations with cast iron sheaves and matched belts standard with a 1.5 drive service factor. Installed and aligned to provide reduced vibration levels and minimize installation costs.



## Modular Construction (HPA)

The lightweight design makes the HPA plenum fans easy to transport and stack. There are no fasteners on the external casing, making it clean and easy to install. Inlet and outlet flanges makes connecting adjacent units quick and easy.



## Wheels



### 7-Bladed (APD)

Backward curved centrifugal wheel with seven blades, carbon steel materials and powder coated. Wheel features high efficiency operation with welded construction.



### 12-Bladed (APM, APH, HPA)

Backward inclined airfoil centrifugal wheel constructed from an aluminum material. The design saves energy and improves overall sound quality by reducing low frequency tones that are difficult to attenuate.



# Model Comparison



MODEL COMPARISON		APD	APM
Performance	Volume (CFM max ( $m^3/hr$ ))	18,000 (30,600)	41,000 (69,700)
	Static Pressure (Ps max)	10 in. wg (2,490 Pa)	8 in. wg (1,990 Pa)
	Sizes	315 - 630	15 - 36
	Class	-	I, II
Standard Construction	Arrangement, Configuration	4, Horizontal	4, Horizontal 3, Motor on Top 3 Motor on Side 4, Vertical
	Drive Type	Direct	Belt / Direct
	Wheel	7 Blades	12 Blades
	Wheel Type	Backward Curved	Airfoil
	Wheel Material	Coated Steel	Aluminum
	Wheel Construction	Welded	Welded
	Frame Material	Galvanized	Galvanized / Coated Steel
	Frame Construction	Bolted	Bolted
	Bearings	-	Set Screw
	Bearing Life	-	L <sub>10</sub> 40,000 Hours
	Single Pressure Tap	Included	Included
	Factory Vibration Test	Yes	Optional
		BV-4	BV-3
AMCA Certification	Sound and Air	Sound and Air	
Accessories	Belt Guard	-	Yes
	Extended Life Bearings	-	L <sub>10</sub> 80,000 Hours
	Extended Lube Lines Kit	-	Yes
	Fan Monitoring System	-	Yes
	Inlet Connection	-	-
	Inlet Guard	Yes	Yes
	Isolation Base	-	-
	Painted Construction	-	Yes
	Protective Cage	-	Yes
	Shaft Guard	-	-
	Inlet Damper	-	-
	Blank-off Panel	-	-
	Sure-Aire™ Airflow Measurement	Yes	Yes, with Electronics
	Vibration Isolators	Yes	Yes
Options	Warranty	1, 2 or 3 years	1, 2 or 3 years
	Quick Build	5, 10, and 15 Day	5, 10, and 15 Day





	APH	HPA	MODEL COMPARISON	
	209,000 (355,100)	45,000 (76,500)	Volume (CFM max ( $m^3/hr$ ))	<b>Performance</b>
	12.5 in. wg (3,110 Pa)	7 in. wg (1,740 Pa)	Static Pressure (Ps max)	
	12-73	15-36	Sizes	
	I, II, III	-	Class	
	4, Horizontal 3, Motor on Top 3, Motor on Side 3, Motor on Base 1, Motor on Base 4, Vertical	4, Horizontal	Arrangement, Configuration	<b>Standard Construction</b>
	Belt / Direct	Direct	Drive Type	
	12 Blades	12 Blades	Wheel	
	Airfoil	Airfoil	Wheel Type	
	Aluminum	Aluminum	Wheel Material	
	Welded	Welded	Wheel Construction	
	Coated Steel	Galvanized	Frame Material	
	Welded	Bolted	Frame Construction	
	Concentric Locking	-	Bearings	
	L <sub>10</sub> 80,000 Hours	-	Bearing Life	
	Included	Included	Single Pressure Tap	
	Yes	Yes	Factory Vibration Test	
	Belt: BV-3 Direct: BV-5	BV-4		
	Sound and Air	Sound and Air	AMCA Certification	
	Yes	-	Belt Guard	<b>Accessories</b>
	L <sub>10</sub> 200,000 Hours	-	Extended Life Bearings	
	-	Yes	Extended Lube Lines Kit	
	Yes	Yes	Fan Monitoring System	
	Slip Fit	-	Inlet Connection	
	Yes	Yes	Inlet Guard	
	Yes	-	Isolation Base	
	Standard	-	Painted Construction	
	Yes	Yes	Protective Cage	
	Arrangement 1 Only	-	Shaft Guard	
	-	Yes	Inlet Damper	
	-	Yes	Blank-off Panel	
	Yes, with Electronics	Yes, with Electronics	Sure-Aire™ Airflow Measurement	
	Yes	Yes	Vibration Isolators	
	1, 2 or 3 years	1, 2 or 3 years	Warranty	<b>Options</b>
	5 and 10 Day	-	Quick Build	

- |   |                       |                                      |
|---|-----------------------|--------------------------------------|
| 1. <i>Bearing, Drive Side</i>                 | 6. <i>Inlet Cone</i>  | 10. <i>Protective Cage (4 sided)</i> |
| 2. <i>Bearing, Opposite Drive Side</i>        | 7. <i>Inlet Guard</i> | 11. <i>Shaft</i>                     |
| 3. <i>Belt Guard</i>                          | 8. <i>Isolators</i>   | 12. <i>Thrust Isolators</i>          |
| 4. <i>Belt(s), Shaft Pulley, Motor Pulley</i> | 9. <i>Motor</i>       | 13. <i>Wheel</i>                     |
| 5. <i>Drive Frame</i>                         |                       |                                      |

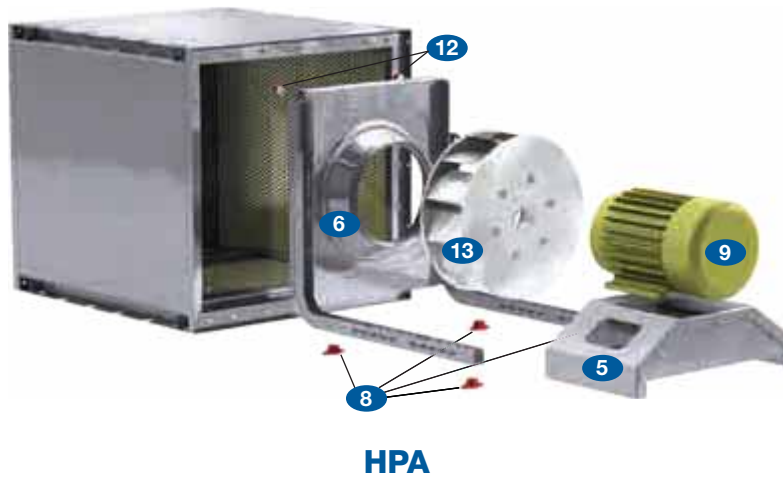
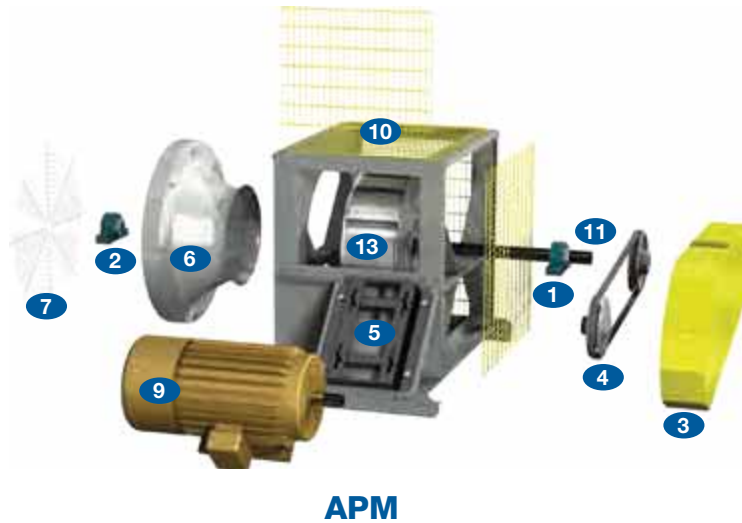
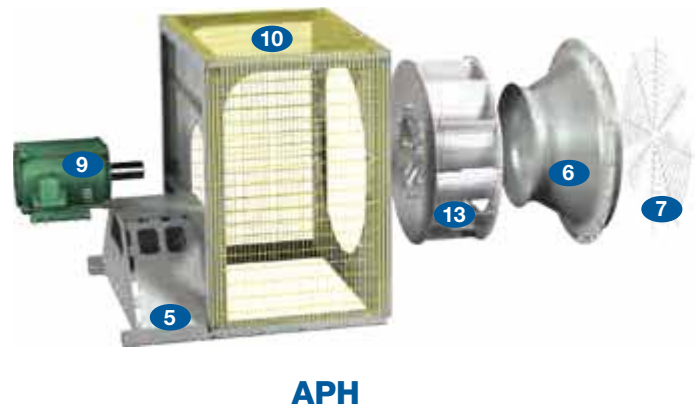
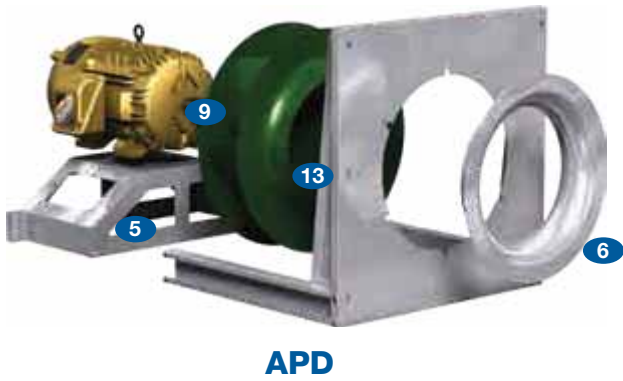

## Model Number Codes:

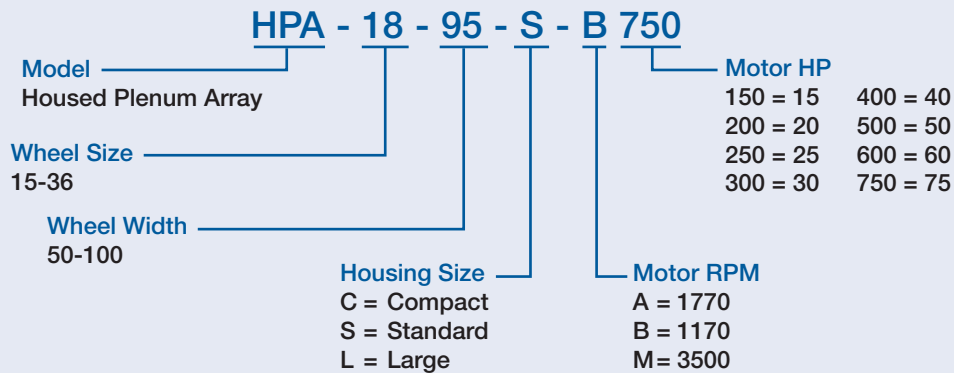
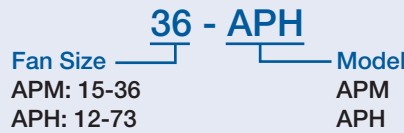
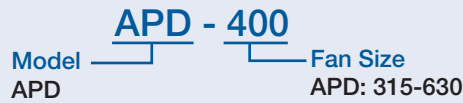

## Vibration Analysis

All plenum fans are tested at the design speed in the factory after final assembly. Fans are checked for amp draw and levels recorded. APD, APH and HPA (APM optional) are also subjected to a complete vibration analysis in three planes. The recorded filter-in vibration levels at the FRPM meet the requirements of AMCA/ANSI Standard 204-05 (Balance Quality and Vibration Levels for Fans). A permanent record of the test is kept on file at the factory for future reference. A copy of the test report is available upon request.

The following vibration limits apply to an assembled fan tested in Greenheck's factory.



Fan Category	Rigidly Mounted in./s	Flexibly Mounted in./s
BV-1	.50	.60
BV-2	.20	.30
BV-3	.15	.20
BV-4	.10	.15
BV-5	.08	.10

## APD Arrangement 4, Horizontal

Size	A	A/2	B*	B (max)	C	Motor Frame Size	Weight* (lbs)
						Max	
315	17.5	8.8	18.0	21.5	17.5	184	91
355	19.7	9.9	18.9	22.4	19.7	184	100
400	22.2	11.1	22.2	24.2	22.2	215	193
450	25.0	12.5	27.1	30.1	25.0	256	399
500	27.8	13.9	28.3	31.2	27.7	256	417
560	31.0	15.5	29.6	32.6	31.0	256	446
630	35.0	17.5	32.8	38.0	34.9	286	587

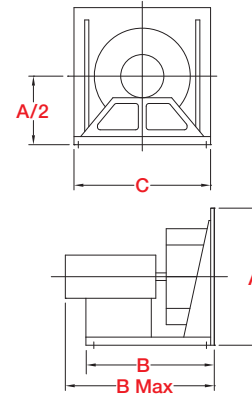

All dimensions are in inches.

\* Based on maximum motor frame size.

## HPA Arrangement 4, Horizontal

Size	Standard Housing					Weight* (lbs.)	Compact Housing					Weight* (lbs.)	Large Housing					Weight* (lbs.)	
	A	B	C^	Maximum Stacked Modules	Motor Frame Size		A	B	C^	Maximum Stacked Modules	Motor Frame Size		A	B	C^	Maximum Stacked Modules	Motor Frame Size		
					Max						Max						Max		
15	29.00	29.00	32.06	4	215T	215	-	-	-	-	-	-	-	31.50	31.50	37.00	4	256T	250
16	31.50	31.50	37.00		256T	250	29.00	29.00	32.06	4	215T	215	34.38	34.38	38.19		256T	290	
18	34.38	34.38	38.19	3	256T	290	31.50	31.50	37.00	3	256T	250	37.25	37.25	39.56	3	256T	340	
20	37.25	37.25	39.56		286T	340	34.38	34.38	38.19		256T	290	41.00	41.00	42.19		286T	380	
22	41.00	41.00	42.19		286T	380	37.25	37.25	39.56		256T	340	44.75	44.75	43.75		286T	425	
24	44.75	44.75	43.75	2	286T	425	41.00	41.00	42.19	2	286T	380	48.94	48.94	47.56	2	286T	680	
27	48.94	48.94	47.56		286T	680	44.75	44.75	43.75		286T	425	53.81	53.81	48.94		326T	820	
30	53.81	53.81	48.94	2	326T	820	48.94	48.94	47.56	2	286T	680	58.81	58.81	51.06	2	326T	960	
33	58.81	58.81	51.06		326T	960	53.81	53.81	48.94		326T	820	64.56	64.56	51.06		326T	1100	
36	64.56	64.56	51.06		326T	1100	58.81	58.81	51.06		326T	960	-	-	-		-	-	

All dimensions are in inches.

^ Does not account for motors or accessories.

\* Weight is less motor.

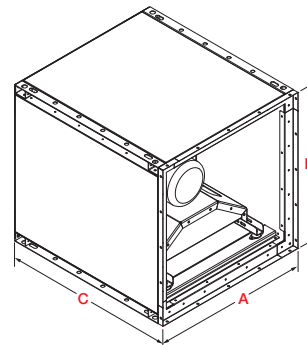



## APM Arrangement 4, Horizontal

Size	A	A/2	B*	Motor Frame Size			Weight* (lbs)		
				Min		Max	Class I	Class II	Class III
				Class I	Class II				
15	21.0	10.5	29.3	143	143	215	85	85	85
16	23.1	11.6	30.4	143	143	215	94	94	94
18	25.6	12.8	35.9	143	143	256	116	116	118
20	28.0	14.0	37.3	182	182	256	131	131	133
22	31.2	15.6	38.9	182	213	256	151	156	160
24	34.3	17.2	40.6	182	213	256	194	199	204
27	37.8	18.9	42.5	213	213	256	229	229	239
30	42.0	21.0	46.8	213	213	286	315	318	326
33	46.2	23.1	49.0	254	254	286	371	388	396
36	46.2	23.1	51.6	254	254	286	416	416	419

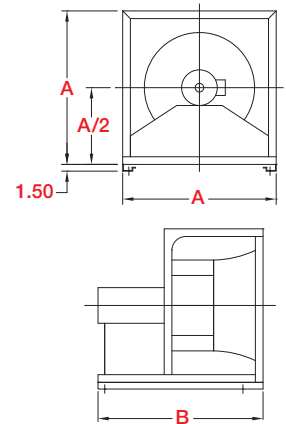

All dimensions are in inches.

\* Based on maximum motor frame size.

## APM Arrangement 3, Motor on Top

Size	A	A/2	B	C		D		Motor Frame Sizes				Weight* (lbs)	
				Class		Class		Min - Class		Max - Class		Class	
				I	II	I	II	I	II	I	II	I	II
18	25.6	12.8	23.9	27.3	27.9	36.9	36.9	56	145	184	184	165	176
20	28.0	14.0	25.3	28.6	29.3	41.0	41.0	56	182	215	215	199	206
22	31.2	15.6	28.9	32.3	32.9	44.1	44.1	56	182	215	215	238	252
24	34.3	17.2	30.6	34.0	35.3	49.2	49.2	56	184	254	254	334	348
27	37.8	18.9	32.5	35.9	37.1	52.7	52.7	56	213	256	256	378	390
30	42.0	21.0	34.8	38.8	39.4	56.9	58.3	56	213	256	286	498	533
33	46.2	23.1	38.5	42.5	43.8	62.5	62.5	56	215	284	286	621	653
36	46.2	23.1	41.1	45.1	46.4	62.5	64.6	143	215	284	326	666	726

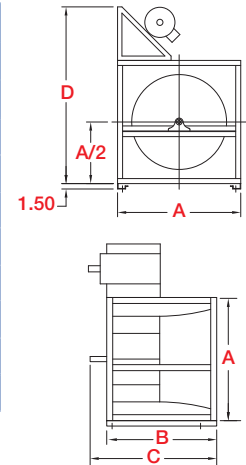

All dimensions are in inches.

\* Based on maximum motor frame size.

## APM Arrangement 3, Motor on Side

Size	A	A/2	B	C		D		Motor Frame Sizes				Weight* (lbs)	
				Class		Class		Min - Class		Max - Class		Class	
				I	II	I	II	I	II	I	II	I	II
18	25.6	12.8	23.9	27.3	27.9	36.9	36.9	56	145	184	184	168	179
20	28.0	14.0	25.3	28.6	29.3	41.0	41.0	56	182	215	215	202	209
22	31.2	15.6	28.9	32.3	32.9	44.1	44.1	56	182	215	215	242	257
24	34.3	17.2	30.6	34.0	35.3	49.2	49.2	56	184	254	254	339	354
27	37.8	18.9	32.5	35.9	37.1	52.7	52.7	56	213	256	256	384	396
30	42.0	21.0	34.8	38.8	39.4	56.9	58.3	56	213	256	286	507	542
33	46.2	23.1	38.5	42.5	43.8	62.5	62.5	56	215	284	286	632	663
36	46.2	23.1	41.1	45.1	46.4	62.5	64.6	143	215	284	326	677	737

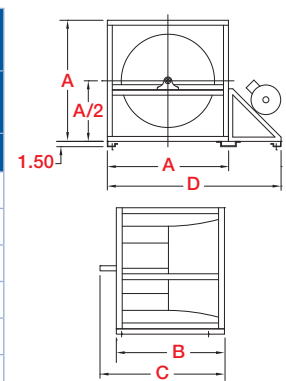

All dimensions are in inches.

\* Based on maximum motor frame size.

## APH Arrangement 4, Horizontal

Size	A	A/2	B*			Motor Frame Sizes						Weight* (lbs)*		
			Class			Min - Class			Max - Class			Class		
			I	II	III	I	II	III	I	II	III	I	II	III
15	21.0	10.5	29.3	29.3	33.0	143	143	143	215	215	256	82	82	87
16	23.1	11.6	34.1	34.1	34.1	143	143	143	256	256	256	96	96	96
18	25.6	12.8	35.9	35.9	37.4	143	143	143	256	256	286	117	117	139
20	28.0	14.0	37.3	37.3	40.3	182	182	182	256	256	326	131	131	184
22	31.2	15.6	38.9	40.4	41.9	182	213	213	256	286	326	152	183	216
24	34.3	17.2	40.6	42.1	43.6	182	213	213	256	286	326	178	212	248
27	37.8	18.9	42.5	44.0	45.5	213	213	213	256	286	326	267	306	351
30	42.0	21.0	46.8	48.3	49.1	213	213	213	286	326	365	382	432	437
33	46.2	23.1	50.5	51.4	51.4	254	254	254	326	365	365	507	521	529
36	46.2	23.1	54.0	54.0	56.3	254	254	254	365	365	405	549	549	556
40	51.1	25.6	56.8	56.8	62.7	284	284	284	365	365	445	711	711	757
44	56.4	28.2	62.3	62.3	65.9	284	284	284	405	405	445	857	868	905
49	62.3	31.2	69.8	69.8	69.8	324	324	324	445	445	445	1162	1181	1233
54	68.6	34.3	73.7	73.7	73.7	324	324	324	445	445	445	1340	1396	1406
60	76.0	38.0	78.5	78.5	78.5	364	364	364	445	445	445	1324	1683	1755

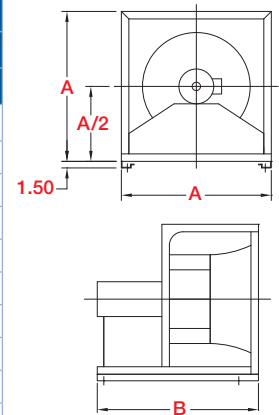

All dimensions are in inches.

\* Based on maximum motor frame size.

## APH Arrangement 3, Motor on Top

Size	A	A/2	B	C		D		Motor Frame Size				Weight (lbs)*	
				Class		Class		Min - Class		Max - Class		Class	
				I	II	I	II	I	II	I	II	I	II
18	25.6	12.8	23.9	27.3	27.9	36.9	36.9	143	145	184	184	141	152
20	28.0	14.0	25.3	28.6	29.3	41.0	41.0	143	182	215	215	168	175
22	31.2	15.6	28.9	32.3	32.9	44.1	44.1	143	182	215	215	205	219
24	34.3	17.2	30.6	34.0	35.3	49.2	49.2	143	184	254	254	281	295
27	37.8	18.9	32.5	35.9	37.1	52.7	52.7	143	213	256	256	324	336
30	42.0	21.0	34.8	38.8	39.4	56.9	58.3	143	213	256	286	449	475
33	46.2	23.1	38.5	42.5	43.8	62.5	62.5	143	215	284	286	564	596
36	46.2	23.1	41.1	45.1	46.4	62.5	64.6	143	215	284	326	607	654
40	51.1	25.6	43.9	48.6	49.2	67.4	69.5	145	254	286	326	844	886
44	56.4	28.2	49.4	54.0	55.3	74.8	74.8	145	256	324	326	1065	1115

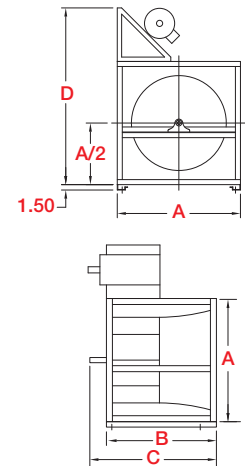

All dimensions are in inches.

\* Based on maximum motor frame size.

## APH Arrangement 3, Motor on Side

Size	A	A/2	B	C		D		Motor Frame Size				Weight (lbs)*	
				Class		Class		Min - Class		Max - Class		Class	
				I	II	I	II	I	II	I	II	I	II
18	25.6	12.8	23.9	27.3	27.9	36.9	36.9	143	145	184	184	147	158
20	28.0	14.0	25.3	28.6	29.3	41.0	41.0	143	182	215	215	175	182
22	31.2	15.6	28.9	32.3	32.9	44.1	44.1	143	182	215	215	212	227
24	34.3	17.2	30.6	34.0	35.3	49.2	49.2	143	184	254	254	293	308
27	37.8	18.9	32.5	35.9	37.1	52.7	52.7	143	213	256	256	337	348
30	42.0	21.0	34.8	38.8	39.4	56.9	58.3	143	213	256	286	467	493
33	46.2	23.1	38.5	42.5	43.8	62.5	62.5	143	215	284	286	584	616
36	46.2	23.1	41.1	45.1	46.4	62.5	64.6	143	215	284	326	628	675
40	51.1	25.6	43.9	48.6	49.2	67.4	69.5	145	254	286	326	873	915
44	56.4	28.2	49.4	54.0	55.3	74.8	74.8	145	256	324	326	1102	1152

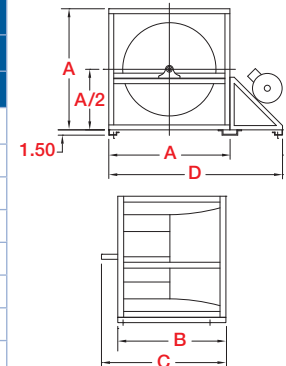

All dimensions are in inches.

\* Based on maximum motor frame size.

## APH Arrangement 1, Motor on Base

Size	A	A/2	B	C*			Weights (lbs)*		
				Class			Class		
				I	II	III	I	II	III
12	21.0	10.5	21.2	24.0	24.6	-	64	68	-
15	21.0	10.5	23.1	25.8	26.4	27.1	72	81	81
16	23.1	11.6	24.7	27.5	28.1	28.7	80	86	89
18	25.6	12.8	27.2	30.6	31.2	31.8	100	107	110
20	28.0	14.0	29.2	32.5	33.2	34.4	121	126	130
22	31.2	15.6	31.7	35.1	35.7	36.9	143	153	165
24	34.3	17.2	34.2	37.6	38.8	39.4	168	179	202
27	37.8	18.9	37.0	40.4	41.6	42.2	243	252	272
30	42.0	21.0	40.9	44.9	45.5	46.7	300	312	338
33	46.2	23.1	44.2	48.2	49.5	50.1	367	395	431
36	46.2	23.1	48.1	52.1	53.4	55.4	414	435	458
40	51.1	25.6	52.3	57.0	57.6	59.6	541	554	597
44	56.4	28.2	57.1	61.7	63.0	65.6	619	656	696
49	62.3	31.2	62.6	67.9	68.5	71.1	851	890	980
54	68.6	34.3	68.5	73.8	75.8	77.0	1134	1212	1235
60	76.0	38.0	75.5	80.7	84.0	84.0	1394	1475	1606
66	84.0	42.0	82.2	88.1	90.7	90.7	1741	1864	1877
73	92.4	46.2	90.0	95.9	98.5	98.5	1953	2075	2128

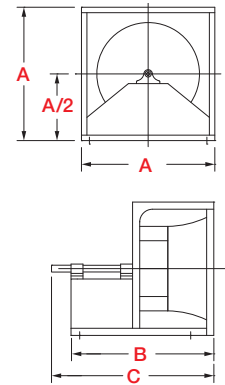

All dimensions are in inches.

\* Based on maximum motor frame size.

## APH Arrangement 3, Motor on Base

Size	A	A/2	B	C*			Weights (lbs)*		
				Class			Class		
				I	II	III	I	II	III
18	25.6	12.8	20.9	24.3	24.9	25.6	109	120	124
20	28.0	14.0	22.3	25.6	26.3	27.5	127	134	137
22	31.2	15.6	25.9	29.3	29.9	31.2	160	174	187
24	34.3	17.2	27.6	31.0	32.3	32.9	218	233	261
27	37.8	18.9	29.5	32.9	34.1	34.8	260	272	293
30	42.0	21.0	31.8	35.8	36.4	37.6	370	386	417
33	46.2	23.1	35.5	39.5	40.8	41.4	471	502	543
36	46.2	23.1	38.1	42.1	43.4	45.4	513	540	566
40	51.1	25.6	40.9	45.6	46.2	48.2	722	740	785
44	56.4	28.2	46.4	51.0	52.3	54.9	905	954	996
49	62.3	31.2	49.8	55.0	55.6	58.3	1069	1112	1221
54	68.6	34.3	53.7	58.9	60.9	62.2	1223	1311	1350
60	76.0	38.0	58.0	63.3	66.5	66.5	1446	1539	1682
66	84.0	42.0	62.5	68.4	71.0	71.0	1794	1863	1944
73	92.4	46.2	67.8	73.6	76.3	76.3	2112	2188	2318

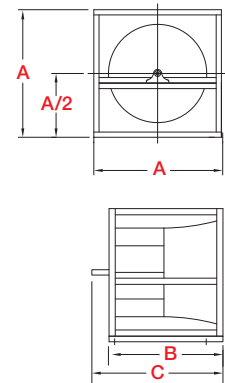

All dimensions are in inches.

\* Based on maximum motor frame size.

# Plenum Fan Offering

**APD** - straight forward design that is compact, low maintenance and efficient. Utilizing a bolted framework that is galvanized, the APD features a 7-bladed, backward curved wheel. Model designed for light and medium duty applications.

Maximum Volume	18,000 cfm
Maximum Pressure	10 in. wg
AMCA Sound and Air Performance	

**APM** - provides higher efficiency while maintaining a compact size. This is an excellent selection for retrofit and replacement applications and in variable air volume systems. Utilizing a bolted framework that is either galvanized or coated, the APM, has a cost effective price point for light and medium duty applications. Quiet and efficient operation is achieved through a 12-bladed, airfoil aluminum wheel. This design saves energy and improves the overall sound quality by reducing low frequency tones that are difficult to attenuate. APM units are available in belt and direct drive with basic accessory options.

Maximum Volume	41,000 cfm
Maximum Pressure	8 in. wg
AMCA Sound and Air Performance	

**APH** - designed and engineered for superior performance and reliability. With welded construction, coated framework, multiple configurations and the highest performance capabilities, model APH is ideal for industrial applications. APH features the exact same high efficiency / low sound 12-bladed wheel as the APM plenum. The APH is available in both belt and direct drive with an extensive accessory offering.

Maximum Volume	209,000 cfm
Maximum Pressure	12.5 in. wg
AMCA Sound and Air Performance	

**HPA** - a direct drive plenum fan mounted inside a sound attenuating housing designed and engineered to provide superior performance and reliability in commercial and industrial applications. Model HPA can be used as a single fan in a sound critical application or in parallel to construct a fan array system. The HPA features a modular design with a structural housing that allows multiple modules to stack side-by-side and on top of one another to form an array or fan wall. Typical applications include packaged, built-up and custom air handlers, general supply and return systems and retrofit projects

Maximum Volume	45,000 cfm
Maximum Pressure	7 in. wg
AMCA Sound and Air Performance	



## Our Commitment

*As a result of our commitment to continuous improvement, Greenheck reserves the right to change specifications without notice.*

Product warranties can be found online at [Greenheck.com](http://Greenheck.com), either on the specific product page or in the literature section of the website at [Greenheck.com/Resources/Library/Literature](http://Greenheck.com/Resources/Library/Literature).

