

Quick Start Guide

SQ MIXED FLOW SIDE DISCHARGE



SQ MIXED FLOW IOM



- This Quick Start Guide does not replace the Installation Operation Manual (IOM), refer to the IOM for more information

Parts List

- (1) Fan
- (1) Outlet panel (installed on fan from factory)
Dependent on discharge selected
- (1) Isolator kit (optional)
- Square Duct Mounting Adapter Kit(s) (optional)
Quantity dependent on discharge selected

Tools List

- Impact Driver
- 1/2 inch Socket

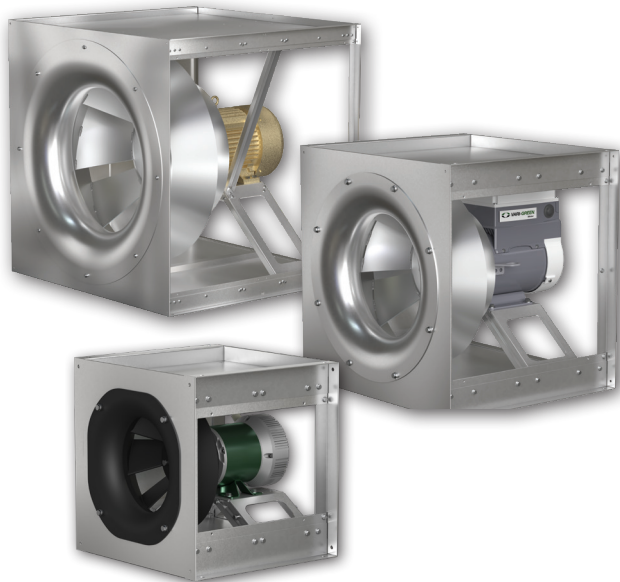

Step 1 - Remove Access Door(s)

- Determine the proper discharge configuration based on application and how the fan was ordered from the factory (see to the right)
- Use an Impact driver and a 1/2 inch socket to remove the 5/16 inch fasteners and access door(s) on left and/or right side of unit if airflow is desired in that direction

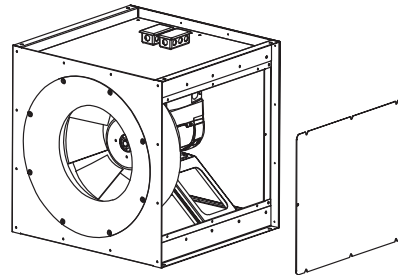
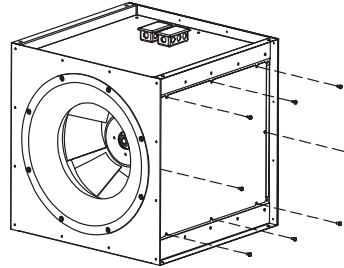

- The number of access doors and fasteners will change depending on unit size
- Save all fasteners from access door to install duct work or Square Duct Adapter flanges
- Left and Right discharges will have a blank off panel installed on the inline discharge of the unit
- **Do not power up fan without removing at least one discharge panel**

Discharge Configurations

INLINE

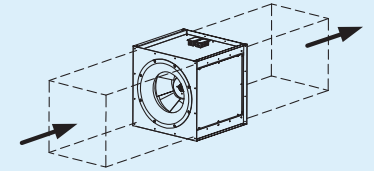

LEFT

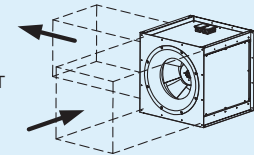

RIGHT

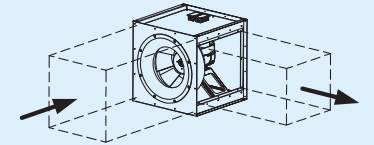

LEFT & RIGHT

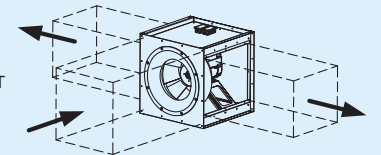

LEFT & INLINE

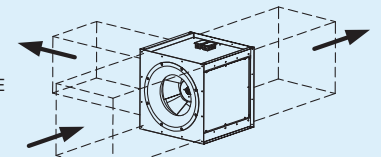

RIGHT & INLINE

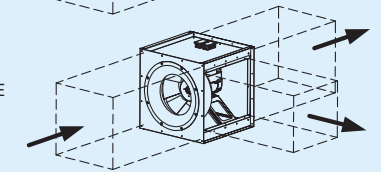

LEFT, RIGHT
& INLINE

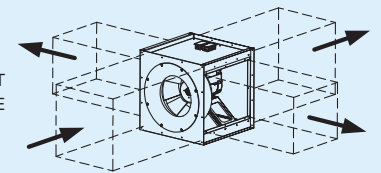

Step 2 - Remove Housing Fasteners

- Remove (4) additional 5/16 inch fasteners per side on the left and/or right sides of the unit to allow installation of duct work or square duct adapter flanges (see below)
- Save all fasteners to install duct work or Square Duct Adapter flanges

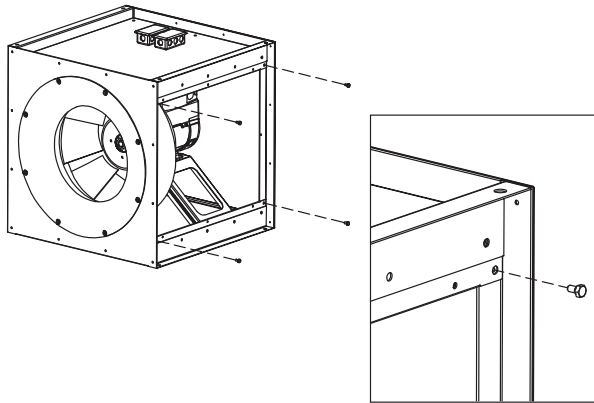

Step 3 - Mount Square Duct Adapters (Optional)

If purchased, square duct adapter flanges are provided for the specific discharge configuration that was ordered

- Square duct adapter will come in (2) or (4) piece designs depending on unit size (see below)

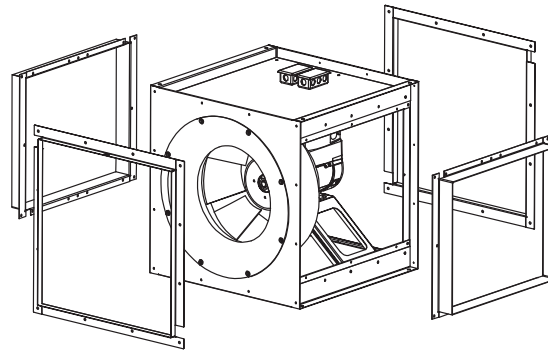
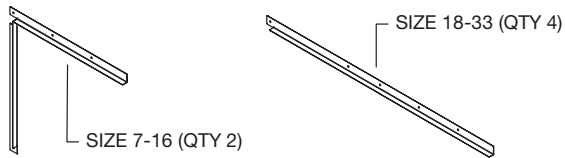

- Mount square duct adapters to inlet and outlet(s) depending on discharge configuration using appropriate number of flange pieces and 5/16 semi-gimlet fasteners removed in Steps 1 and 2
- Reinstall fasteners that were removed in Step 2 in the corners of the left and right discharge flanges, not doing so will void warranty and could lead to structural issues with the fan**

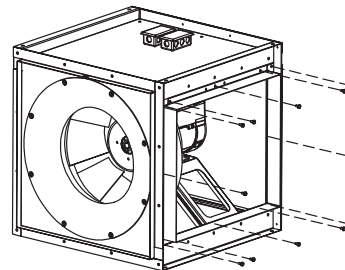
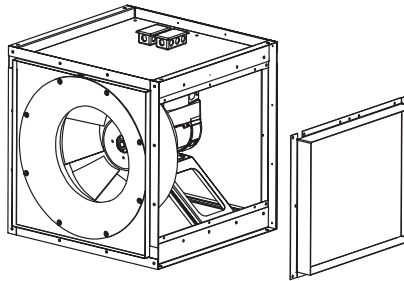

Step 4 - Mount Unit to Structure

- Fans can be mounted in horizontal or vertical applications
- Isolation is recommended but not required. Please use isolation if ordered
- Place unit in desired location and mount to structure

Step 5 - Install Ductwork to Fan

- Using holes on inlet and outlet(s) or using Square Duct Adapter flanges, mount ductwork to fan in all desired locations
- For Left and Right discharges reuse the 5/16 inch semi-gimlet fasteners removed in Steps 1 and 2.
- Reinstall fasteners that were removed in Step 2 in the corners of the left and right discharge flanges, not doing so will void warranty and could lead to structural issues with the fan**
- Hardware for the inlet and Inline discharge is supplied by others
- Install fan with approximately three wheel diameters of straight duct before and after the fan (see below)
- Flexible duct connectors are recommended for mounting to the inlet and outlets of the fan (see below)

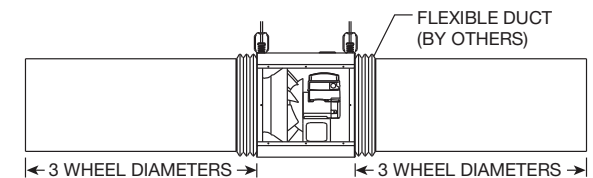

- Do not power up fan without removing at least one discharge panel**

