

Grilles and Registers

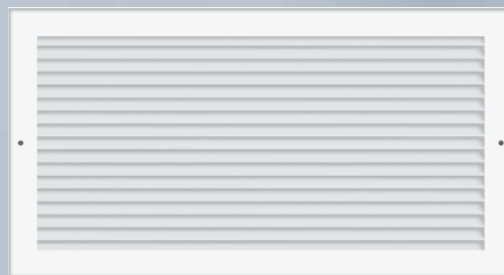

BUILDING VALUE IN AIR.

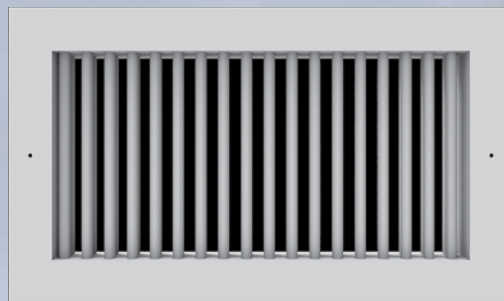

December
2021

TABLE OF CONTENTS

Greenheck offers a complete line of Grilles and Registers, including standard supply and return grilles, filter grilles, heavy duty grilles, industrial grilles and a full line of security products.

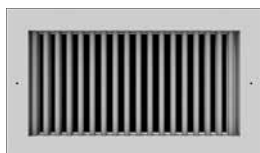

Supply/Return Grilles and Registers

Greenheck offers a complete line of supply and return grilles that are available in aluminum, steel and stainless steel construction. These products are offered in single and double deflection, perforated face and cube core which fulfills any architectural or performance need.

PAGE 4



Spiral Duct Grilles

Greenheck offers a double deflection and perforated face supply spiral duct grilles as well as a perforated face return. The spiral duct grille is available in both aluminum and galvanized steel construction specifically designed for spiral or round duct applications.

PAGE 100



Filter Grilles

Greenheck offers a complete line of filter grilles which include louvered, cubed core and perforated face. All filter grilles are designed for either 1" or 2" thick filters (by others) and include a hinged face for filter access. Greenheck filter grilles are available in aluminum, steel and stainless steel construction and are an excellent choice for exhaust and return applications

PAGE 114

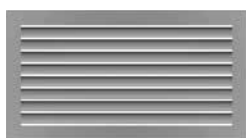

Heavy Duty Grilles

GREENHECK offers heavy duty return grilles which are designed for applications where the grilles need to withstand abuse. GREENHECK heavy duty grilles are an excellent choice for return or exhaust in high traffic areas such as gymnasiums.

PAGE 132



Door/Transfer Grilles

GREENHECK offers a complete line of door and transfer grilles with a variety of options for sight proof or lightproof applications.

PAGE 145



Industrial Grilles

GREENHECK offers a complete line of industrial grilles designed for ceiling and high sidewall installations requiring high capacity and performance.

PAGE 150



Specialty Grilles

Greenheck offers a full line of specialized grilles including jet nozzles, air nozzles, under floor diffusers and round high velocity grilles. Applications requiring high ceilings and long throw distances such as auditoriums, civic centers, arenas and computer rooms are a perfect fit for these grilles.

PAGE 193



Security Grilles

Greenheck offers a complete line of security products including perforated, lattice, and screened face heavy duty steel grilles for use in minimum and maximum security areas, these include correctional facilities, prisons and psychiatric hospitals where security is paramount.

PAGE 214



Grilles and Registers Accessories

Greenheck GRD accessories are primarily designed to improve the overall air handling performance of the system. Proper application of duct and outlet accessories aide in the control of the air distribution system.

PAGE 285

SUPPLY AND RETURN GRILLES

MODELS XG-V



MODELS XG-4002

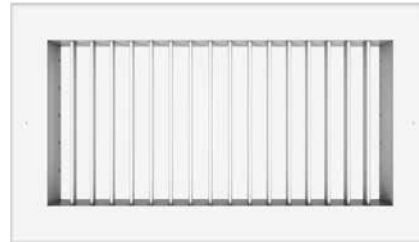

MODEL XG-4004

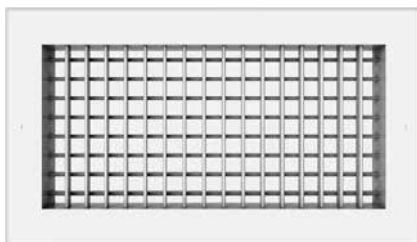

MODEL XG-LS4



MODEL XG-CC5

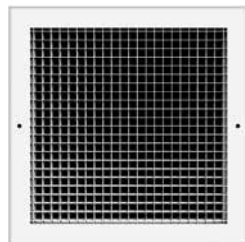

MODEL XG-RPF

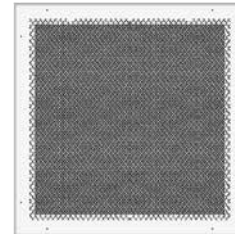

GREENHECK offers a complete line of supply and return grilles available in steel and aluminum construction to meet any application.

Aluminum Stamped Frame Supply

The V series of grilles combine the advantages of corrosion resistant construction and durability with attractive design, solid performance and competitive pricing.

- XG-V – Single deflection
- XG-VH – Double deflection
- XG-VM – Single deflection with integral multi-shutter damper

PAGE 7

Aluminum/Steel Single Deflection Supply

The XG-4002 series of single deflection supply grilles are available with vertical or horizontal blades and aluminum or steel construction. The 4002 series sets the standard for performance and appearance in the industry. This series is available in both surface mount and T-bar Lay-in frame styles.

- XG-4002 – Aluminum
- XG-4002S – Steel
- XG-4002M – Aluminum – Integral multi-shutter damper
- XG-4002SM – Steel – Integral multi-shutter damper
- XG-4002-AF – Aluminum – Air Foil Blade
- XG-4002S-AF – Steel – Air Foil Blade

PAGE 14

Aluminum/Steel Double Deflection Supply

The XG-4004 series of double deflection grilles are available with vertical or horizontal front blades and in aluminum or steel construction. The 4004 series is the most flexible type of grille and is available in both surface mount and T-bar Lay-in frame styles.

- XG-4004 – Aluminum
- XG-4004S – Steel
- XG-4004-AF – Aluminum – Air Foil Blade
- XG-4004S-AF – Steel – Air Foil Blade

PAGE 18

Aluminum Curved Blade Grilles

The XG-L series of curved blade grilles are available in a wide range of sizes with 1-way to 4-way directional air patterns. The L series has individually adjustable blades that can be directed to suit the application.

- XG-L/S – Single deflection -1-way
- XG-LT/XG-ST/XG-LTC – Single deflection - 2-way
- XG-LS3/XG-LTC3 – Single deflection – 3-way
- XG-LS4 – Single deflection – 4-way
- XG-LM/XG-SM/XG-LMH – Single deflection – 1-way – Integral multi-shutter damper
- XG-LTM/XG-STM/XG-LTCM/XG-LTMH – Single deflection 2-way Integral multi-shutter damper
- XG-LTC3M/XG-LS3M – Single deflection – 3-way – Integral multi-shutter damper
- XG-LS4M – Single deflection – 4-way – Integral multi-shutter damper
- XG-LV/XG-SH – Double deflection – 1-way
- XG-LTV/XG-STH – Double deflection – 2-way

PAGE 40

Aluminum/Steel Louvered Return

The series XG-RH grilles are designed with 40° blade deflection to minimize direct sight lines into the ductwork. The series RH is available in aluminum, extruded aluminum or steel construction. This series is available in both surface mount and T-bar Lay-in frame styles.

- XG-RH – Aluminum
- XG-RHE – Extruded aluminum
- XG-RH – Steel

PAGE 60

Aluminum/Steel Return

The series XG-4002R return grille is designed to match the 4000 series supply models. These grilles are available in both aluminum and steel construction. This series is available in both surface mount and T-bar Lay-in frame styles. 0° or 40° fixed blades.

- XG-4002R – Aluminum
- XG-4002RS – Steel

PAGE 73

Aluminum Cube Core Return

The series XG-CC5 cubed core grilles is designed for return or exhaust where maximum free area is desired and “see through” is not a concern. The series XG-CC5 is available in both surface mount and T-bar Lay-in frame styles.

- XG-CC5 – 1/2” x 1/2” x 1/2”
- XG-CC15 – 1/2” x 1/2” x 1”
- XG-CC1 – 1” x 1” x 1”
- XG-CC5R-6 – 1/2” x 1/2” x 1/2” – Removable core
- XG-CC5-TBC-6 – 1/2” x 1/2” x 1/2” – Channel frame
- XG-CC5S – 1/2” x 1/2” x 1/2” – Steel frame

PAGE 83

Aluminum/Steel Perforated Return

The XG-RP series perforated face return or exhaust is designed to blend into the ceiling system and provide a clean, uncluttered architectural appearance. The XG-RP series is available in aluminum or steel construction and surface mount and T-bar Lay-in frame styles.

- XG-RP – Aluminum
- XG-SRP – Steel

PAGE 91

MODEL XG-V



Supply - Single Deflection Supply Grilles and Registers – Aluminum/Model XG-V-1

Air Outlets shall be model XG-V manufactured by GREENHECK. Units shall be single deflection supply grilles of aluminum construction and with a one piece formed border and a single set of vertical deflection blades. The units shall be the size and quantity as outlined in the plans and specifications.

Border shall be 1 1/4" wide with aerodynamically shaped deflector blades on .666" centers. Deflector blades shall be individually adjustable. Units shall be designed for surface mounting applications and be provided with screw holes on the face of the device. Blades shall pivot in friction mounting retainers. Retainers shall hold the deflector blade position throughout the specified operating range of the device.

Metal friction wires are not acceptable.

Optional opposed blade damper shall be constructed of steel (Model XG-OBD) or aluminum (Model XG-OBDA). Damper must be operable from the face of the diffuser.

Supply - Double Deflection Supply Grilles and Registers – Aluminum/Model XG-VH-1

Air Outlets shall be model XG-VH-1 manufactured by GREENHECK. Units shall be double deflection supply grilles of aluminum construction and with a one piece formed border and front vertical deflection blades on the front and rear mounted horizontal blades. Optional opposed blade damper shall be constructed of aluminum. Damper must be operable from the face of the diffuser. The units shall be the size and quantity as outlined in the plans and specifications.

Border shall be 1 1/4" wide with aerodynamically shaped deflector blades on .666" centers. Deflector blades shall be individually adjustable. Units shall be provided with screw holes on the face for surface mounting.

The units shall be the size and quantity as outlined in the plans and specifications.

Blades shall pivot in friction mounting retainers. Retainers shall hold the deflector blade position throughout the specified operating range of the device.

Metal friction wires are not acceptable.

Optional opposed blade damper shall be constructed of steel (Model XG-OBD) or aluminum (Model XG-OBDA). Damper must be operable from the face of the diffuser.

Supply - Single Deflection with Multi Shutter Damper - Supply Grilles and Registers – Aluminum/Model XG-VM-1

Air Outlets shall be model XG-VM-1 manufactured by GREENHECK. Units shall be single deflection supply grilles with a face operated multi-shutter damper.

Units shall be of aluminum construction and with a one piece formed border and front vertical deflection. Border shall be 1 1/4" wide with aerodynamically shaped deflector blades on .666" centers. Deflector blades shall be individually adjustable. Units shall be provided with screw holes on the face for surface mounting.

Blades shall pivot in friction mounting retainers. Retainers shall hold the deflector blade position throughout the specified operating range of the device.

Metal friction wires are not acceptable.

The units shall be the size and quantity as outlined in the plans and specifications.

Performance Specification

The manufacturer shall provide published performance data. Data shall be tested in accordance to ANSI/ASHRAE Standard 70- 2006.

□ **Model: XG-V-1 (Single Deflection Grille - Vertical Blades)**

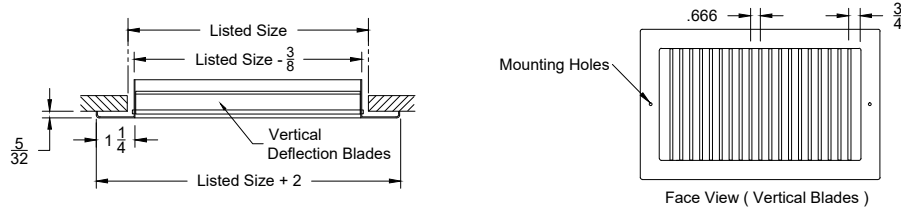

□ **Model: XG-VM-1 (Single Deflection Register - With Multi-Shutter Damper)**

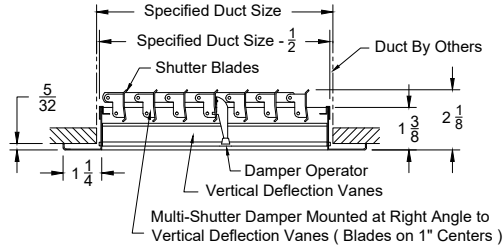

□ **Option: XG-V-1 XG-OBD (With XG-OBD Steel Opposed Blade Damper or XG-OBDA Aluminum Opposed Blade Damper)**

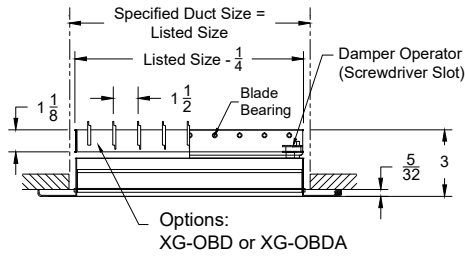

Available Sizes	
8 x 4	12 x 8
8 x 6	14 x 4
10 x 4	14 x 6
10 x 6	14 x 8
10 x 8	16 x 6
12 x 4	16 x 8
12 x 6	

□ **Model: XG-VH-1 (Double Deflection Grille - Vertical Front Blades)**

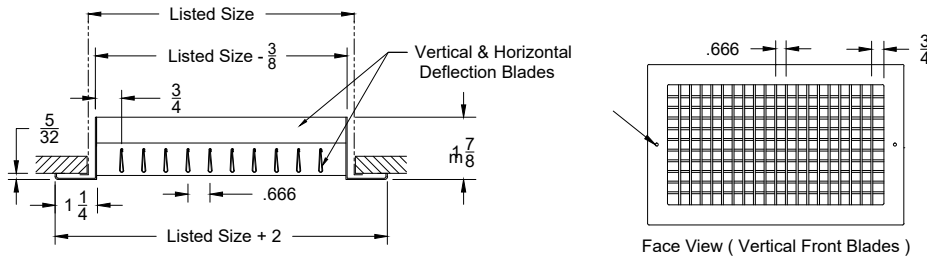

□ **Option: XG-VH-1 XG-OBD (Double Deflection Register) (With XG-OBD Steel Opposed Blade Damper or XG-OBDA Aluminum Opposed Blade Damper)**

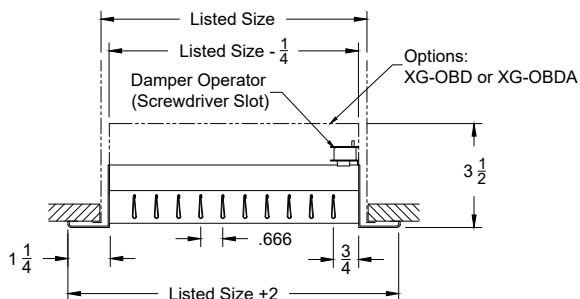

Available Sizes	
8 x 4	12 x 8
8 x 6	14 x 4
10 x 4	14 x 6
10 x 6	14 x 8
10 x 8	16 x 6
12 x 4	16 x 8
12 x 6	

SERIES XG-V PERFORMANCE DATA
MODEL XG-V, XG-VM, XG-VH

Size	Duct Area ft ²	Nk Vel	200	300	400	500	600	700	800	900	1000
		Ps	.007	.015	.027	.042	.061	.083	.109	.137	.170
06x06	.25	CFM	38	57	76	95	115	134	153	172	191
		NC	-	-	-	-	15	20	24	28	31
		Throws	2-4-8	5-7-14	7-10-14	8-12-18	10-14-20	12-15-21	13-16-23	14-17-24	15-18-25
08x04	.22	CFM	33	49	66	82	99	115	131	148	164
		NC	-	-	-	-	15	20	24	27	30
		Throws	2-4-9	4-7-13	6-9-15	8-12-17	9-13-18	11-14-20	12-15-21	13-16-22	14-17-24
08x06	.33	CFM	53	80	106	133	159	186	212	239	265
		NC	-	-	-	12	17	22	26	29	32
		Throws	2-6-12	6-9-16	8-12-19	10-15-21	12-16-23	14-18-25	15-19-27	16-20-28	17-21-30
08x08	.44	CFM	75	112	149	186	223	260	297	334	371
		NC	-	-	-	13	18	23	27	30	33
		Throws	3-6-14	6-10-19	9-14-22	11-17-25	14-19-27	16-21-29	18-22-31	19-24-33	20-25-35
10x04	.28	CFM	43	64	85	106	127	148	169	190	212
		NC	-	-	-	11	16	21	25	28	31
		Throws	2-5-10	5-8-15	7-10-17	9-13-19	10-15-21	12-16-22	14-17-24	15-18-25	15-19-27
10x06	.42	CFM	69	103	137	171	205	239	273	307	341
		NC	-	-	-	13	18	23	27	30	33
		Throws	3-6-13	6-10-19	9-13-21	11-17-24	13-19-24	15-20-28	17-21-30	19-23-32	20-24-34
10x08	.56	CFM	93	140	186	233	280	326	373	419	466
		NC	-	-	-	14	19	24	28	31	35
		Throws	3-7-16	7-12-22	10-16-25	13-19-28	16-22-31	18-23-33	20-25-35	22-27-38	23-28-40
10x10	.69	CFM	120	179	239	298	358	417	476	536	595
		NC	-	-	-	15	20	25	29	32	36
		Throws	4-8-18	8-13-25	12-18-28	15-22-32	18-25-35	21-27-38	23-28-40	25-30-43	26-32-45
12x04	.33	CFM	53	80	106	133	159	186	212	239	265
		NC	-	-	-	12	17	22	26	29	32
		Throws	2-6-12	6-9-16	8-12-19	10-15-21	12-16-23	14-18-25	15-19-27	16-20-28	17-21-30
12x06	.50	CFM	82	123	164	205	246	287	328	369	410
		NC	-	-	-	13	19	23	27	31	34
		Throws	3-7-15	7-11-20	10-15-24	12-18-26	15-20-29	17-22-31	19-24-33	20-25-35	21-26-37
12x08	.67	CFM	113	170	227	283	340	397	454	510	567
		NC	-	-	-	15	20	25	29	32	35
		Throws	4-8-17	8-13-24	11-17-28	14-21-31	17-24-34	20-26-37	23-28-39	24-29-42	25-31-44
12x12	1.00	CFM	176	264	352	440	528	616	704	792	880
		NC	-	-	-	16	22	27	31	34	37
		Throws	4-10-21	10-16-30	14-21-34	18-27-39	21-30-42	25-32-46	28-34-49	30-37-52	31-39-55

SERIES XG-V PERFORMANCE DATA
MODEL XG-V, XG-VM, XG-VH

Size	Duct Area ft ²	Nk Vel	200	300	400	500	600	700	800	900	1000
		Ps	.007	.015	.027	.042	.061	.083	.109	.137	.170
14x04	.39	CFM	60	90	120	150	180	210	240	270	300
		NC	-	-	-	12	17	22	26	30	33
		Throws	3-6-13	6-9-17	8-13-20	10-16-23	13-17-25	15-19-27	16-20-28	17-21-30	18-23-32
14x06	.58	CFM	97	145	194	242	291	3369	387	436	484
		NC	-	-	-	14	19	24	28	32	35
		Throws	3-7-16	7-12-22	11-16-26	13-20-29	16-22-31	19-24-34	21-26-36	22-27-38	23-29-40
14x08	.78	CFM	135	202	268	335	402	468	535	601	668
		NC	-	-	-	15	21	25	29	33	36
		Throws	4-9-19	9-14-26	12-19-30	16-23-34	19-26-37	22-28-40	25-30-43	26-32-45	27-34-48

PERFORMANCE NOTES FOR SERIES XG-V

All data is tested in accordance with ANSI/ASHRAE 70-2006.

DEFINITION OF UNITS

CFM Cubic Feet per Minute (air)

Nk Vel Neck velocity of air stream in Feet Per Minute

Ps Static pressure = Pt-Pv (inches of water column)

NC Noise criterion, Sound pressure level. NC ratings are based on sound power level (lw)

RE: 10⁻¹² watts minus a 10dB room attenuation in all octave bands.

Throws Non-isothermal horizontal throws (supply air temperature 20° F colder than average room air temperature) values are for 150 fpm - 100 fpm - 50 fpm (feet per minute)

XG-V MODEL NUMBER SPECIFICATION
ALUMINUM STAMPED BORDER

Model		Neck					Available Finishes		
XG-V-1	Single Deflection - Surface Mount		6	8	10	12	14	Standard	
XG-VH-1	Double Deflection - Surface Mount	4		X	X	X	X	01	White
XG-VM-1	Single Deflection - Multi Shutter Damper Surface Mount	6	X	X	X	X	X	Optional	
		8		X	X	X	X	02	Satin Silver
		10			X			03	Black
		12				X		24	Mill
							28	Custom Color	

MODEL XG-4000

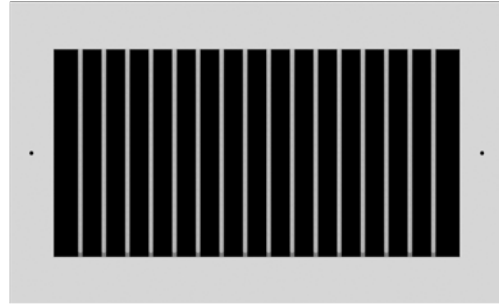

**Model XG-4002 Single Deflection Supply
Grilles and Registers – Aluminum**
XG-V4002-1 – Surface Mount
XG-H4002-1 – Surface Mount
XG-V4002-6 – T-bar Lay-In
XG-H4002-6 – T-bar Lay-In

Air Outlets shall be model XG-V4002 (vertical blades) or XG-H4002 (horizontal blades) manufactured by GREENHECK. Units shall be single deflection supply grilles of aluminum construction and with an extruded aluminum border and a single set of deflection blades. The units shall be the size and quantity as outlined in the plans and specifications.

Border shall be 1 1/4" wide with aerodynamically shaped deflector blades on .666" centers. Deflector blades shall be individually adjustable. Blades shall pivot in friction mounting retainers. Retainers shall hold the deflector blade position throughout the specified operating range of the device.

Metal friction wires are not acceptable.

Model XG-4004
Double Deflection Supply Grilles and Registers – Aluminum
XG-V4004-1 – Surface Mount
XG-H4004-1 – Surface Mount
XG-V4004-6 – T-bar Lay-In
XG-H4004-6 – T-bar Lay-In

Air Outlets shall be model XG-V4004 (vertical front blades) or XG-H4004 (horizontal front blades) manufactured by GREENHECK. Units shall be double deflection supply grilles of aluminum construction and with an extruded border with a front and rear sets of deflection blades. The units shall be the size and quantity as outlined in the plans and specifications.

Border shall be 1 1/4" wide with aerodynamically shaped deflector blades on .666" centers. Deflector blades shall be individually adjustable. The units shall be the size and quantity as outlined in the plans and specifications. Blades shall pivot in friction mounting retainers. Retainers shall hold the deflector blade position throughout the specified operating range of the device.

Metal friction wires are not acceptable.

Model XG-4002M**Single Deflection with Multi Shutter Damper -
Supply Grilles and Registers – Aluminum****XG-V4002M-1 – Surface Mount****XG-H4002M-1 – Surface Mount****XG-V4002M-6 – T-bar Lay-In****XG-H4002M-6 – T-bar Lay-In**

Air Outlets shall be model XG-V4002M (vertical blades) or XG-H4002M (horizontal blades) manufactured by GREENHECK. Units shall be single deflection supply grilles with a face operated multi-shutter damper. Units shall be of aluminum construction and with an extruded aluminum border and a single set of deflection blades. The units shall be the size and quantity as outlined in the plans and specifications.

Border shall be 1 1/4" wide with aerodynamically shaped deflector blades on .666" centers. Deflector blades shall be individually adjustable. Blades shall pivot in friction mounting retainers. Retainers shall hold the deflector blade position throughout the specified operating range of the device.

Metal friction wires are not acceptable.

Model XG-4002S**Single Deflection Supply Grilles and Registers – Steel****XG-V4002XG-S1 – Surface Mount****XG-H4002XG-S1 – Surface Mount****XG-V4002S-6 – T-bar Lay-In****XG-H4002S-6 – T-bar Lay-In**

Air Outlets shall be model XG-V4002S (vertical blades) or XG-H4002S (horizontal blades) manufactured by GREENHECK. Units shall be single deflection supply grilles of steel construction and with a steel border and a single set of deflection blades. The units shall be the size and quantity as outlined in the plans and specifications.

Border shall be 1 1/4" wide with aerodynamically shaped deflector blades on .666" centers. Deflector blades shall be individually adjustable. Blades shall pivot in friction mounting retainers. Retainers shall hold the deflector blade position throughout the specified operating range of the device.

Metal friction wires are not acceptable.

Model XG-4004S**Double Deflection Supply Grilles and Registers – Steel****XG-V4004XG-S1 – Surface Mount****XG-H4004XG-S1 – Surface Mount****XG-V4004S-6 – T-bar Lay-In****XG-H4004S-6 – T-bar Lay-In**

Air Outlets shall be model XG-V4004 (vertical front blades) or XG-H4004 (horizontal front blades) manufactured by GREENHECK. Units shall be double deflection supply grilles of steel construction and with a steel border with a front and rear sets of deflection blades. The units shall be the size and quantity as outlined in the plans and specifications.

Border shall be 1 1/4" wide with aerodynamically shaped deflector blades on .666" centers. Deflector blades shall be individually adjustable. The units shall be the size and quantity as outlined in the plans and specifications. Blades shall pivot in friction mounting retainers. Retainers shall hold the deflector blade position throughout the specified operating range of the device.

Model XG-4002SM**Single Deflection with Multi Shutter Damper - Supply Grilles and Registers –Steel****XG-V4002SM-1 – Surface Mount****XG-H4002SM-1 – Surface Mount****XG-V4002SM-6 – T-bar Lay-In****XG-H4002SM-6 – T-bar Lay-In**

Air Outlets shall be model XG-V4002SM (vertical blades) or XG-H4002SM (horizontal blades) manufactured by GREENHECK. Units shall be single deflection supply grilles with a face operated multi-shutter damper. Units shall be of steel construction and with a steel border and a single set of deflection blades. The units shall be the size and quantity as outlined in the plans and specifications.

Border shall be 1 1/4" wide with aerodynamically shaped deflector blades on .666" centers. Deflector blades shall be individually adjustable. Blades shall pivot in friction mounting retainers. Retainers shall hold the deflector blade position throughout the specified operating range of the device.

Metal friction wires are not acceptable.

For Surface mounting:

Units shall be designed for surface mounting applications and be provided with counter sunk screw holes on the face of the device.

For T-Bar Lay-in:

Units shall be designed to integrate into the specified ceiling system.

Damper Accessories (Optional):

Optional opposed blade damper shall be constructed of steel (model XG-OBD) or aluminum (model XG-OBDA). Damper must be operable from the face of the diffuser.

Performance Specification:

The manufacturer shall provide published performance data. Data shall be tested in accordance to ANSI/ASHRAE Standard 70- 2006

Paint Specification:

Process shall be anodic electrodeposition using an anodic acrylic paint. Units shall undergo pre-treatment including a pressurized spray stage using an alkaline cleaner and a de-ionized water rinse.

MODEL XG-4002-1

Sidewall Supply Grilles and Registers Aluminum - Single Deflection

- Models: **XG-V4002-1** Single Deflection Grille - Vertical Blades
XG-H4002-1 Single Deflection Grille - Horizontal Blades
XG-V4002M-1 Single Deflection Register - Vertical Blades - With Multi-Shutter Damper
XG-H4002M-1 Single Deflection Register - Horizontal Blades - With Multi-Shutter Damper

Model: **XG-H4002-1** Single Deflection Grille - Horizontal Blades

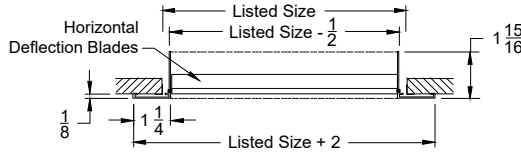

Face View - Horizontal

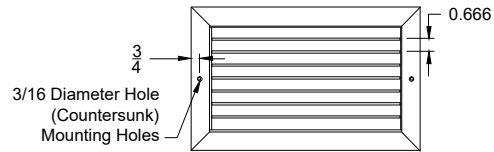

Model: **XG-V4002-1** Single Deflection Grille - Vertical Blades

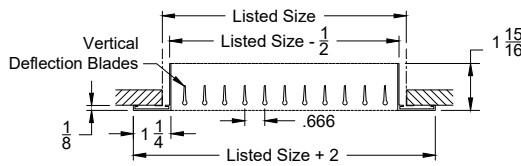

Face View - Vertical Blades

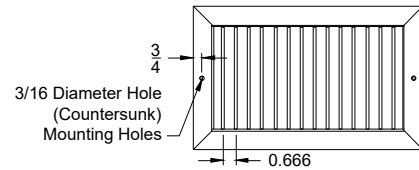

Model: **XG-H4002M-1** Single Deflection Register
Multi-Shutter Damper - Horizontal Front Blades

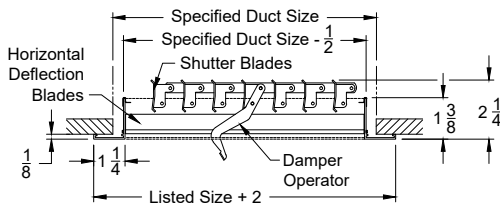

Model: **XG-V4002M-1** Single Deflection Register
Multi-Shutter Damper - Vertical Front Blades

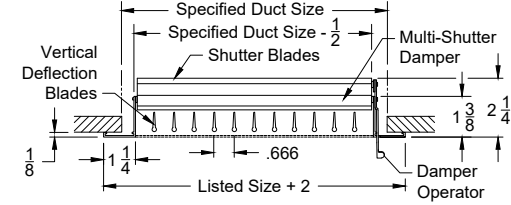

Model: **XG-V4002-1** Single Deflection Register - Vertical Blades
with Opposed Blade Damper

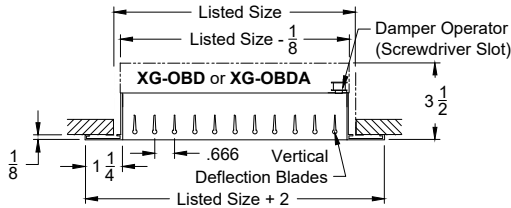

Model: **XG-H4002-1** Single Deflection Register - Horizontal Blades
with Opposed Blade Damper

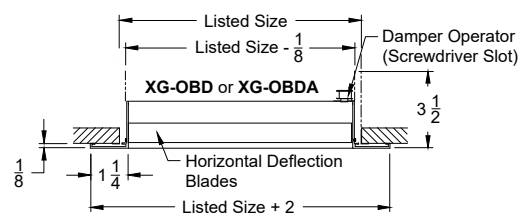

Notes: (check if provided)

1. Available Finishes	2. Available Accessories	3. Available Options	4. Construction Details
Standard Finish: <input type="checkbox"/> 01 White. Optional Finish (no extra charge): <input type="checkbox"/> 24 Mill Finish. Optional Finish (extra charge): <input type="checkbox"/> 02 Satin Silver <input type="checkbox"/> 03 Black <input type="checkbox"/> 28 Custom Color / Set Up Charge	<input type="checkbox"/> XG-OBDA - Steel Opposed Blade Damper. <input type="checkbox"/> XG-OBDA - Aluminum Opposed Blade Damper. <input type="checkbox"/> XG-L9 - Equalizing Grid. <input type="checkbox"/> XG-PF - Plaster Frame. <input type="checkbox"/> XG-TR - Transition Square / Rectangular to Round <input type="checkbox"/> XG-TR - Deep Transition Used With Dampers up to 22 x 22 <input type="checkbox"/> XG-LIPF - Lay-In Plaster Frame		<ul style="list-style-type: none"> Aluminum construction. Oversized units made in multiple sections, each with full flanges. Mullion strips provided for joining units in field. Option: <input type="checkbox"/> NSH - No Screw Holes

MODEL XG-4002PCF

Industrial Spiral Duct Grille / Single Deflection / Curve Flange Aluminum Construction

Models: XG-4002PCF-1 Aluminum - Single Deflection Grille - Curved Flange - Vertical Blades

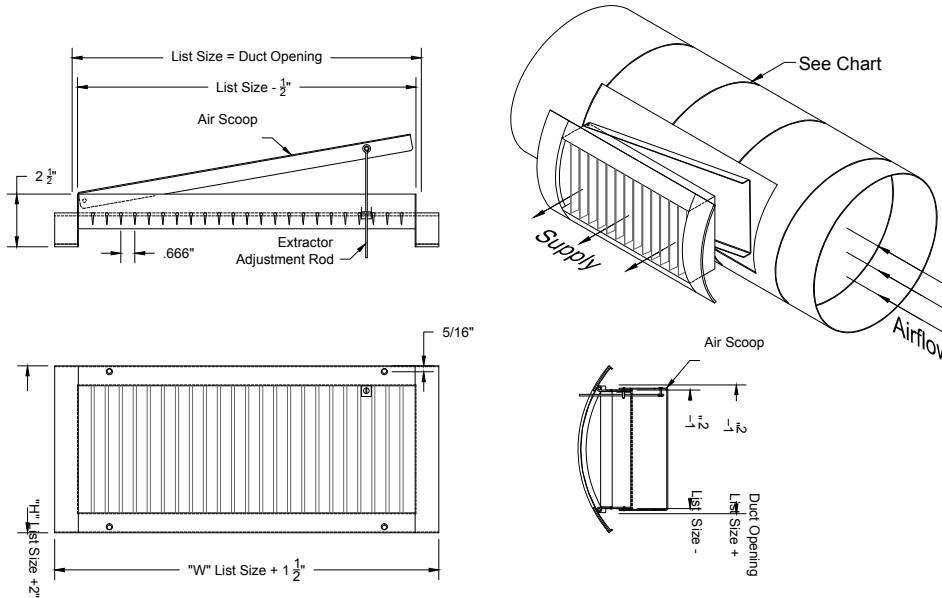

Available in listed sizes only

Height	Width													
	10"	12"	14"	16"	18"	20"	24"	30"	36"	40"	42"	44"	46"	48"
	MINIMUM / MAXIMUM DUCT DIAMETER													
3"	6 / 16	6 / 16	6 / 16	6 / 16	6 / 16	6 / 16	6 / 16	6 / 16	6 / 16	6 / 16	6 / 16	6 / 16	6 / 16	6 / 16
4"	8 / 16	8 / 16	8 / 16	8 / 16	8 / 16	8 / 16	8 / 16	8 / 16	8 / 16	8 / 16	8 / 16	8 / 16	8 / 16	8 / 16
6"	10 / 28	10 / 28	10 / 28	10 / 28	10 / 28	10 / 28	10 / 28	10 / 28	10 / 28	10 / 28	10 / 28	10 / 28	10 / 28	10 / 28
8"	14 / 30	14 / 30	14 / 30	14 / 30	14 / 30	14 / 30	14 / 30	14 / 30	14 / 30	14 / 30	14 / 30	14 / 30	14 / 30	14 / 30
10"	-	-	16 / 30	16 / 30	16 / 30	16 / 30	16 / 30	16 / 30	16 / 30	16 / 30	16 / 30	16 / 30	16 / 30	16 / 30
12"	-	-	-	-	18 / 30	18 / 30	18 / 30	18 / 30	18 / 30	18 / 30	18 / 30	18 / 30	18 / 30	18 / 30

Notes: (check if provided)

1. Available Finishes	2. Available Accessories	3. Available Options	4. Construction Details
Standard Finish: <input type="checkbox"/> 01 White Standard Finish (no extra charge): <input type="checkbox"/> 24 Mill Finish Optional Finish (extra charge): <input type="checkbox"/> 02 Satin Silver <input type="checkbox"/> 03 Black <input type="checkbox"/> 28 Custom Color / Setup Charge		<input type="checkbox"/> Air Scoop <input type="checkbox"/> No Air Scoop	<ul style="list-style-type: none"> Ends are supplied with foam gasket to seal around duct. Units are surface mount. Provided with screw template to mount into duct. Air Scoop includes wire for operation.

MODEL XG-4002S

Sidewall Supply Grilles and Registers Steel - Single Deflection

Models: **XG-H4002S-1** Single Deflection Grille - Horizontal Blades
XG-V4002S-1 Single Deflection Grille - Vertical Blades
XG-H4002S-6 Single Deflection Grille - Lay In T-Bar - Horizontal Blades
XG-V4002S-6 Single Deflection Grille - Lay In T-Bar - Vertical Blades

Model: XG-H4002S-1 - Single Deflection Grille with Horizontal Blades

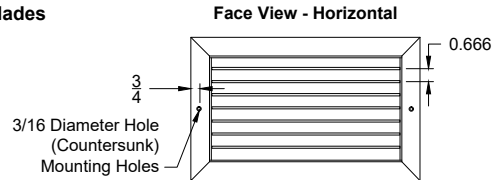
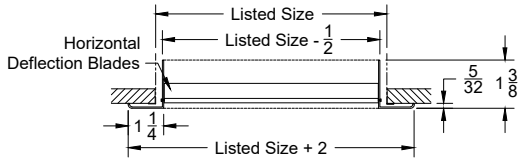

Model: XG-V4002S-1 - Single Deflection Grille with Vertical Blades

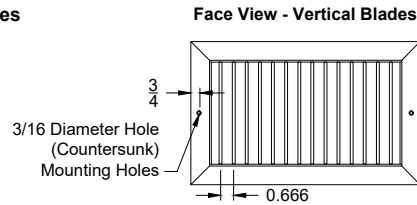
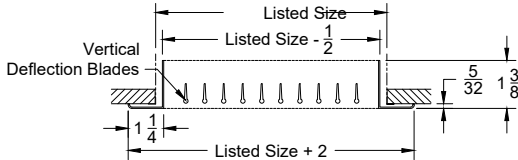

Model: XG-H4002S-6 Single Deflection Grille - Lay In T-Bar - Horizontal Blades

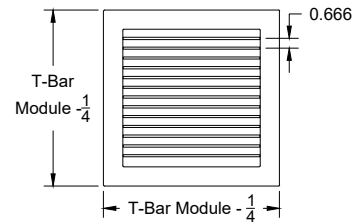
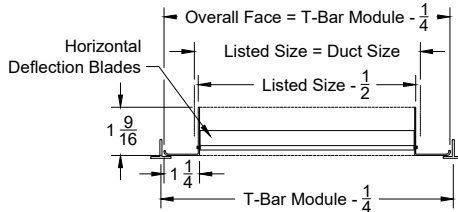

Model: XG-V4002S-6 Single Deflection Grille - Lay In T-Bar - Vertical Blades

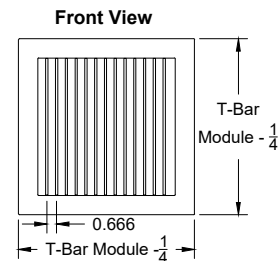
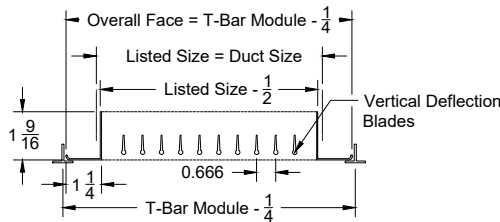

Notes: (check if provided)

1. Available Finishes	2. Available Accessories	3. Available Options	4. Construction Details
Standard Finish: <input type="checkbox"/> 01 White. Optional Finish (extra charge): <input type="checkbox"/> 02 Satin Silver <input type="checkbox"/> 03 Black. <input type="checkbox"/> 28 Custom Color / Setup Charge	<input type="checkbox"/> XG-OBDA - Steel Opposed Blade Damper <input type="checkbox"/> XG-OBDA - Aluminum Opposed Blade Damper <input type="checkbox"/> XG-L9 - Equalizing Grid. <input type="checkbox"/> XG-PF - Plaster Frame. <input type="checkbox"/> XG-TBPF - T-Bar Plaster Frame <input type="checkbox"/> XG-TR - Transition Square / Rectangular to Round up to 22 x 22 <input type="checkbox"/> XG-TR - Deep Transition Used with Dampers <input type="checkbox"/> XG-FGBP - R6 Fiberglass Backpan 24x24 Panel Only	<input type="checkbox"/> IS - Insect Screen <input type="checkbox"/> NSH - No Screw Hole	<ul style="list-style-type: none"> Steel Construction Oversized units made in multiple sections, each with full flanges. Mullion strips provided for joining units in field.

MODEL XG-4002SM

Sidewall Supply Grilles and Registers Steel - Single Deflection

Models: **XG-4002SM** Single Deflection Grille - Vertical Blades - With Multi-Shutter Damper

Face View (Vertical Blades)

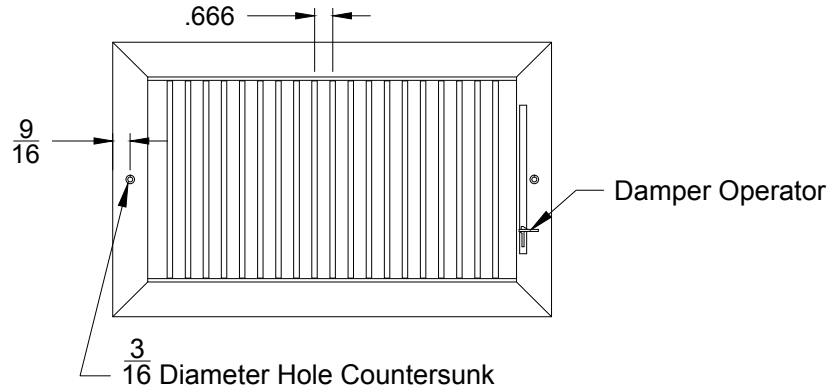

**Model: XG-4002SM (Single Deflection Register)
(Multi-Shutter Damper-Vertical Blades)**

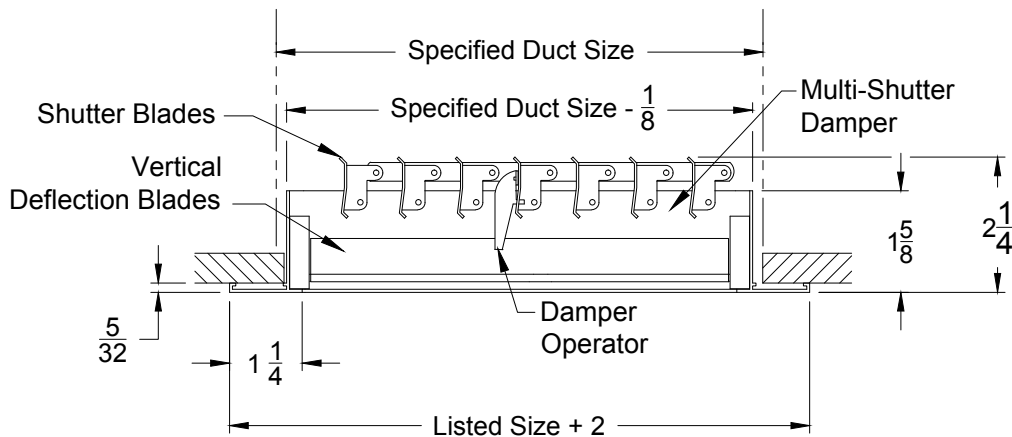

Notes: (check if provided)

1. Available Finishes	2. Available Accessories	3. Available Options	4. Construction Details
Standard Finish: <input type="checkbox"/> 01 White. Optional Finish (extra charge): <input type="checkbox"/> 02 Satin Silver <input type="checkbox"/> 03 Black <input type="checkbox"/> 28 Custom Color / Setup Charge	<input type="checkbox"/> XG-L9 - Equalizing Grid <input type="checkbox"/> XG-PF - Plaster Frame <input type="checkbox"/> XG-LIPF - Lay-In Plaster Frame <input type="checkbox"/> NSH - No Screw Holes		

MODEL XG-4004-1

Sidewall Supply Grilles and Registers Aluminum - Double Deflection

- Models: XG-H4004-1 Double Deflection Grille - Horizontal Blades
 XG-V4004-1 Double Deflection Grille - Vertical Blades

Model: XG-H4004-1 (Double Deflection Grille)(Horizontal Front Blades)

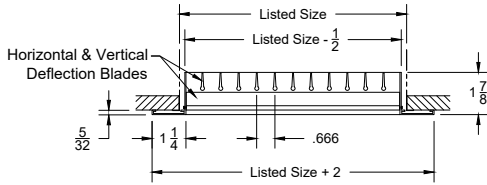

Face View (Double Deflection) (Horizontal Front Blades)

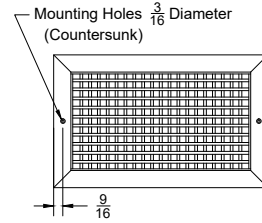

Model: XG-V4004-1 (Double Deflection Grille) (Vertical Front Blades)

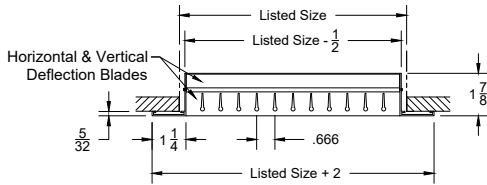

Face View (Double Deflection) (Vertical Front Blades)

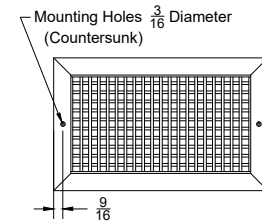

Model: XG-H4004-1 (Double Deflection Register) (With Damper-Horizontal Front Blades)

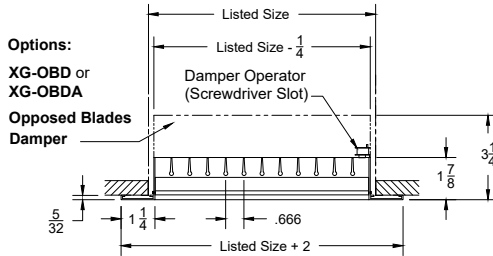

Model: XG-V4004-1 (Double Deflection Register) (With Damper-Vertical Front Blades)

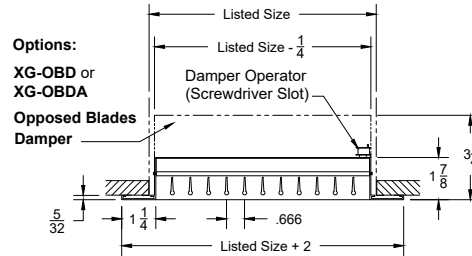

Notes: (check if provided)

1. Available Finishes	2. Available Accessories	3. Options	4. Construction Details
Standard Finish: <input type="checkbox"/> 01 White. Optional Finish (no extra charge): <input type="checkbox"/> 24 Mill Finish. Optional Finish (extra charge): <input type="checkbox"/> 02 Satin Silver <input type="checkbox"/> 03 Black <input type="checkbox"/> 28 Custom Color / Setup Charge	<input type="checkbox"/> XG-OBDA - Steel Opposed Blade Damper. <input type="checkbox"/> XG-OBDA - Aluminum Opposed Blade Damper. <input type="checkbox"/> XG-L9 - Equalizing Grid. <input type="checkbox"/> XG-PF - Plaster Frame. <input type="checkbox"/> XG-TR - Transition Square / Rectangular to Round Up to 22x22 <input type="checkbox"/> XG-TR - Deep Transition Used with Damper <input type="checkbox"/> IS - Insect Screen <input type="checkbox"/> XG-LIPF - Lay-In Plaster Frame		<ul style="list-style-type: none"> Aluminum borders and blades. Oversized units made in multiple sections, each with full flanges. Mullion strips provided for joining units in field. Option: <ul style="list-style-type: none"> XG-NSH No Screw Holes

MODEL XG-4004-1

Sidewall Supply Grilles and Registers Aluminum - Double Deflection

Models: XG-H4004-1 Double Deflection Grille - Horizontal Blades
 XG-V4004-1 Double Deflection Grille - Vertical Blades

Model: XG-H4004-1 (Double Deflection Grille)(Horizontal Front Blades)

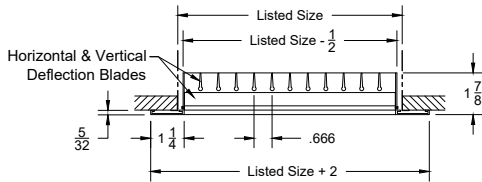

Face View (Double Deflection) (Horizontal Front Blades)

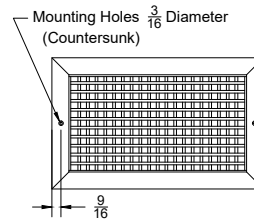

Model: XG-V4004-1 (Double Deflection Grille) (Vertical Front Blades)

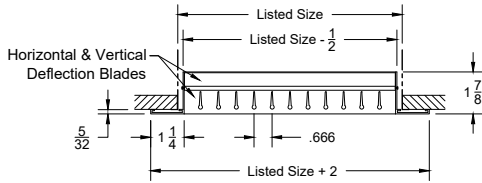

Face View (Double Deflection) (Vertical Front Blades)

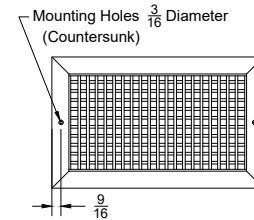

Model: XG-H4004-1 (Double Deflection Register) (With Damper-Horizontal Front Blades)

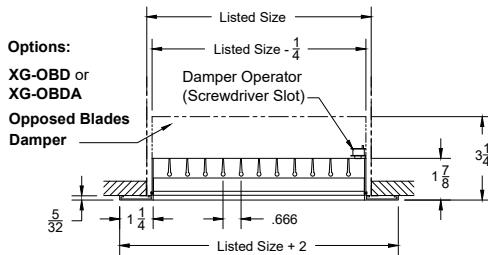

Model: XG-V4004-1 (Double Deflection Register) (With Damper-Vertical Front Blades)

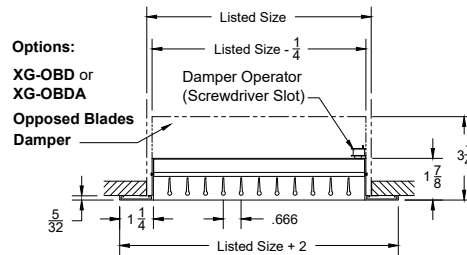

Notes: (check if provided)

1. Available Finishes	2. Available Accessories	3. Options	4. Construction Details
Standard Finish: <input type="checkbox"/> 01 White. Optional Finish (no extra charge): <input type="checkbox"/> 24 Mill Finish. Optional Finish (extra charge): <input type="checkbox"/> 02 Satin Silver <input type="checkbox"/> 03 Black <input type="checkbox"/> 28 Custom Color / Setup Charge	<input type="checkbox"/> XG-OBDD - Steel Opposed Blade Damper. <input type="checkbox"/> XG-OBDA - Aluminum Opposed Blade Damper. <input type="checkbox"/> XG-L9 - Equalizing Grid. <input type="checkbox"/> XG-PF - Plaster Frame. <input type="checkbox"/> XG-TR - Transition Square / Rectangular to Round Up to 22x22 <input type="checkbox"/> XG-TR - Deep Transition Used with Damper <input type="checkbox"/> IS - Insect Screen <input type="checkbox"/> XG-LIPF - Lay-In Plaster Frame		<ul style="list-style-type: none"> Aluminum borders and blades. Oversized units made in multiple sections, each with full flanges. Mullion strips provided for joining units in field. Option: <ul style="list-style-type: none"> XG-NSH No Screw Holes

MODEL XG-4004-6

Sidewall Supply Grilles and Registers Aluminum - Double Deflection

- Models: XG-H4004-6 Double Deflection Grille - Horizontal Front Blades - Lay in T-Bar - With Filler Panel
 XG-V4004-6 Double Deflection Grille - Vertical Front Blades - Lay in T-Bar - With Filler Panel

Model: XG-H4004-6 (Double Deflection Grille) Lay in T-Bar - With Filler Panel
(Horizontal Front Blades)

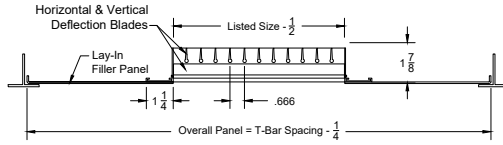

Front View (Double Deflection)
(Horizontal Front Blades)

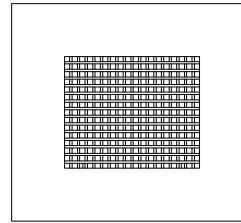

Model: XG-V4004-6 (Double Deflection Grille) Lay in T-Bar - With Filler Panel
(Vertical Front Blades)

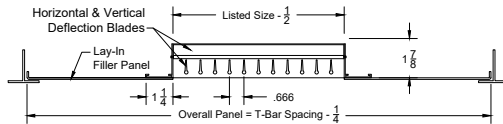

Front View (Double Deflection)
(Vertical Front Blades)

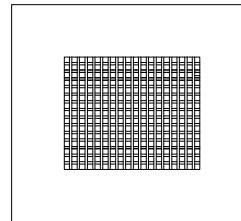

Model: XG-H4004-6 (Double Deflection Grille) Lay in T-Bar - With Filler Panel
(With Damper - Horizontal Front Blades)

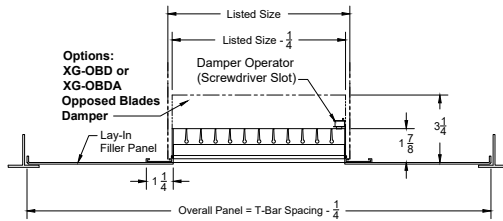

Model: XG-V4004-6 (Double Deflection Grille) Lay in T-Bar - With Filler Panel
(With Damper Vertical Front Blades)

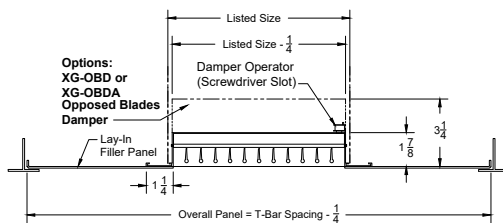

Notes: (check if provided)

1. Available Finishes	2. Available Accessories	3. Options	4. Construction Details
Standard Finish: <input type="checkbox"/> 01 White. Optional Finish (no extra charge): <input type="checkbox"/> 24 Mill Finish. Optional Finish (extra charge): <input type="checkbox"/> 02 Satin Silver <input type="checkbox"/> 03 Black <input type="checkbox"/> 28 Custom Color / Setup Charge	<input type="checkbox"/> XG-OBDD - Steel Opposed Blade Damper. <input type="checkbox"/> XG-OBDA - Aluminum Opposed Blade Damper. <input type="checkbox"/> XG-L9 - Equalizing Grid. <input type="checkbox"/> XG-TBPF - T-Bar Plaster Frame <input type="checkbox"/> XG-TR - Transition Square / Rectangular to Round Up to 22x22 <input type="checkbox"/> XG-TR - Deep Transition Used with Damper <input type="checkbox"/> IS - Insect Screen		<ul style="list-style-type: none"> Aluminum Construction.

MODEL XG-4004XG-S1

Sidewall Supply Grilles and Registers Steel - Double Deflection

Models: **XG-V4004S-1** Double Deflection Grille - Vertical Front Blades
XG-H4004S-1 Double Deflection Grille - Horizontal Front Blades
XG-V4004S-1 XG-OBD Double Deflection Grille - Vertical Front Blades - with Opposed Blade Damper
XG-H4004S-1 XG-OBD Double Deflection Grille - Horizontal Front Blades - with Opposed Blade Damper

Model: **XG-V4004S-1 (Double Deflection Grille - Vertical Front Blades)** Front View (Double Deflection) (Vertical Front Blades)

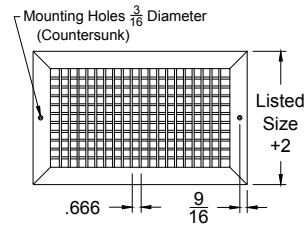
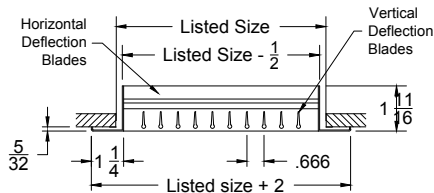

Model: **XG-H4004S-1 (Double Deflection Grille - Horizontal Front Blades)** Front View (Double Deflection) (Horizontal Front Blades)

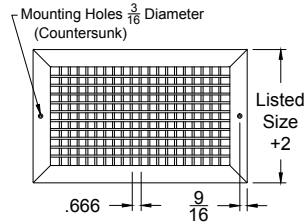
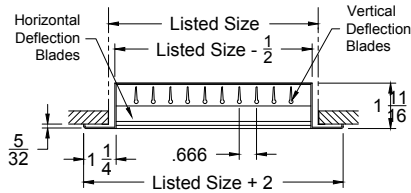

Option: **XG-V4004S-1 XG-OBD (Double Deflection Register)** (Vertical Front Blades)
With Opposed Blade Damper

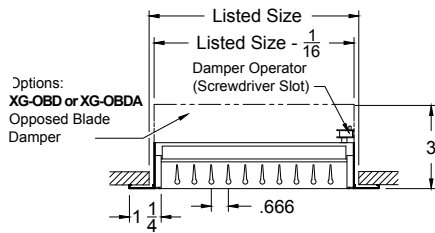

Option: **XG-H4004S-1 XG-OBD (Double Deflection Register)** (Horizontal Front Blades)
With Opposed Blade Damper

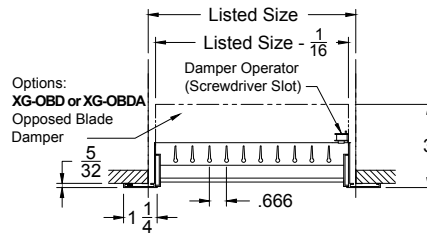

Notes: (check if provided)

1. Available Finishes	2. Available Accessories	3. Available Options	4. Construction Details
Standard Finish: <input type="checkbox"/> 01 White. Optional Finish (extra charge): <input type="checkbox"/> 02 Satin Silver <input type="checkbox"/> 03 Black. <input type="checkbox"/> 28 Custom Color / Setup Charge	<input type="checkbox"/> XG-OBD - Steel Opposed Blade Damper. <input type="checkbox"/> XG-OBDA - Aluminum Opposed Blade Damper. <input type="checkbox"/> XG-L9 - Equalizing Grid. <input type="checkbox"/> XG-PF - Plaster Frame. <input type="checkbox"/> XG-LIPF - Lay-In Plaster Frame <input type="checkbox"/> XG-TR - Transition Square / Rectangular to Round up to 22x22 <input type="checkbox"/> XG-TR - Deep Transition Used with Dampers <input type="checkbox"/> IS - Insect Screen	<input type="checkbox"/> NSH - No Screw Holes	<ul style="list-style-type: none"> ● Steel Construction. ● Oversized units made in multiple sections, each with full flanges. Mullion strips provided for joining units in field.

SERIES XG-4000 PERFORMANCE DATA
**MODELS XG-H/V4002, XG-H/V4004, XG-H/V4002M,
XG-H/V4002S, XG-H/V4004S, XG-H/V4002SM**

Size		Nk Vel	200	300	400	500	600	700	800	1000
		Pt	.007	.015	.027	.042	.061	.083	.108	.169
06x04	Ac ft ²	CFM	24	36	48	60	72	84	96	120
	0.17	NC	-	-	-	-	-	-	11	18
	Throw		2-4-8	4-6-11	5-8-13	7-10-14	8-11-16	9-12-17	10-13-18	12-14-20
06x06	Ac ft ²	CFM	38	57	76	95	114	133	152	190
	0.25	NC	-	-	-	-	-	10	13	20
	Throw		4-8-17	7-12-21	10-15-24	12-17-26	14-20-28	15-21-30	17-23-32	19-24-34
08x08 10x06 12x05	Ac ft ²	CFM	73	110	146	183	219	256	292	365
	0.42	NC	-	-	-	-	11	13	16	22
	Throw		3-6-14	6-10-19	9-14-22	11-17-25	14-19-27	16-21-29	18-22-31	20-25-35
12x06	Ac ft ²	CFM	82	123	164	205	246	287	328	410
	0.50	NC	-	-	-	11	11	13	16	23
	Throw		3-7-15	7-11-20	10-15-24	12-18-26	15-20-29	17-22-31	19-24-33	21-26-37
10x08 14x6	Ac ft ²	CFM	93	140	186	233	279	326	372	465
	0.56	NC	-	-	-	10	12	14	17	23
	Throw		3-7-16	7-12-22	10-16-25	13-19-28	16-22-31	18-23-33	20-25-35	23-28-40
10x10 12x08 16x06	Ac ft ²	CFM	118	172	238	297	357	414	478	592
	0.69	NC	-	-	-	11	13	15	18	24
	Throw		4-8-18	8-13-25	12-18-28	15-22-32	18-25-35	20-27-37	23-28-40	26-32-45
14x08 18x06	Ac ft ²	CFM	134	201	267	335	394	468	534	661
	0.67	NC	-	-	-	11	13	15	18	25
	Throw		4-9-19	9-14-26	13-20-30	16-23-34	19-26-37	23-29-41	25-30-42	27-34-47
12x10 20x06	Ac ft ²	CFM	145	218	290	363	435	509	582	729
	0.83	NC	-	-	10	11	13	16	18	25
	Throw		4-9-19	9-15-27	13-19-31	16-24-35	19-27-38	23-29-41	26-31-44	29-35-49
16x08 22x06	Ac ft ²	CFM	153	230	306	383	459	536	612	765
	0.89	NC	-	-	10	12	14	16	19	25
	Throw		4-9-20	9-15-28	13-20-32	17-25-36	20-28-39	23-30-43	26-32-46	29-36-51
14x10 28x05	Ac ft ²	CFM	170	255	340	425	510	595	680	850
	0.85	NC	-	-	10	12	14	16	19	26
	Throw		4-10-21	10-16-29	14-21-34	18-26-38	21-29-42	25-32-45	28-34-48	31-38-54
12x12 24x06 18x08	Ac ft ²	CFM	176	263	351	439	527	615	701	878
	0.88	NC	-	-	10	12	14	16	19	26
	Throw		8-19-38	14-25-46	21-31-51	25-37-56	29-43-60	33-46-64	37-48-68	41-51-72
30x06 18x10	Ac ft ²	CFM	213	320	426	533	640	746	853	1066
	1.07	NC	-	10	11	13	15	17	20	27
	Throw		5-11-24	11-18-33	16-24-38	20-29-42	24-33-46	27-36-50	31-38-54	35-42-60

SERIES XG-4000 PERFORMANCE DATA
MODELS XG-H/V4002, XG-H/V4004, XG-H/V4002M,
XG-H/V4002S, XG-H/V4004S, XG-H/V4002SM

Size		Nk Vel	200	300	400	500	600	700	800	1000
		Pt	.007	.015	.027	.042	.061	.083	.108	.169
14x14	Ac ft ²	CFM	244	366	488	610	732	853	975	1219
	1.22	NC	-	10	12	13	15	18	21	27
	Throw			5-12-25	12-19-35	17-25-41	21-31-45	25-35-50	29-38-54	33-41-57
36x06 18x12	Ac ft ²	CFM	257	366	514	643	771	900	1028	1285
	1.29	NC	10	11	12	14	16	18	21	28
	Throw			5-12-26	12-19-36	17-26-42	22-32-47	26-36-51	30-39-55	34-42-59
22x10	Ac ft ²	CFM	273	410	546	683	819	956	1092	1385
	1.37	NC	10	11	12	14	16	18	21	28
	Throw			6-12-27	12-20-37	18-27-43	22-33-48	27-37-53	31-40-57	35-43-61
30x08 24x10	Ac ft ²	CFM	295	442	589	736	884	1031	1178	1472
	1.48	NC	10	11	13	14	16	19	21	28
	Throw			6-13-28	13-21-39	18-28-45	23-35-50	28-39-55	32-42-59	36-45-63
16x16	Ac ft ²	CFM	323	485	646	808	969	1131	1292	1615
	1.62	NC	11	12	13	15	17	19	22	28
	Throw			6-14-29	14-22-40	19-29-47	24-36-52	29-40-57	34-44-62	38-47-66

PERFORMANCE NOTES FOR SERIES XG-4000

All data is tested in accordance with ANSI/ASHRAE 70-2006.

DEFINITION OF UNITS

CFM Air volume is cubic feet per minute

Nk Vel Neck Velocity is the airstream velocity in the duct just before it reaches the supply outlet; measured in feet per minute

fpm Velocity of air stream in Feet per Minute

Throw Throw distance in feet are for terminal velocities of 150 fpm, 100 fpm and 50 fpm respectively

NC Noise criterion, sound pressure level NC ratings are based on sound power level (Lw) re: 10⁻¹² watts minus a 10dB room attenuation in all octave bands

Pt Total pressures in inches of water

Ac Actual Core Free Area in square feet

SERIES XG-4000 PERFORMANCE DATA
MODELS XG-H/V4002, XG-H/V4004, XG-H/V4002M,
XG-H/V4002S, XG-H/V4004S, XG-H/V4002SM

Size	Nk Vel		200	300	400	500	600	700	800	1000
	Pt		.007	.015	.027	.042	.061	.083	.108	.169
24x12 36x08 48x06	Ac ft ²	CFM	364	546	727	909	1090	1272	1453	1816
	1.82	NC	11	12	13	15	17	20	22	29
	Throw		6-13-30	14-23-43	20-31-50	26-38-55	31-43-61	36-46-66	40-50-70	45-55-78
18x18	Ac ft ²	CFM	414	621	87	1034	1240	1447	1653	2066
	2.07	NC	12	13	14	16	18	20	23	29
	Throw		7-15-33	15-25-46	22-33-53	27-41-59	33-46-65	38-49-70	43-53-75	48-59-84
30x12 36x10	Ac ft ²	CFM	456	685	914	1142	1371	1600	1829	2386
	2.28	NC	12	13	14	16	18	20	23	30
	Throw		7-16-34	16-26-48	23-34-56	29-43-62	34-48-68	40-52-74	45-56-79	51-62-88
20x20	Ac ft ²	CFM	515	772	1030	1287	1545	1802	2059	2574
	2.59	NC	13	14	15	17	19	21	24	30
	Throw		8-17-37	17-27-51	24-37-59	30-46-66	37-51-72	43-55-78	48-59-83	54-66-93
24x18 36x12	Ac ft ²	CFM	550	826	1101	1377	1653	1928	2204	2755
	2.75	NC	13	14	15	17	19	21	24	31
	Throw		8-18-38	18-28-53	25-38-61	32-47-68	38-53-75	44-57-81	50-61-86	56-68-96
22x22 24x20 48x10	Ac ft ²	CFM	626	940	1254	1567	1881	2195	2509	3136
	3.13	NC	13	14	16	17	19	22	25	31
	Throw		8-19-40	19-30-56	27-40-65	34-50-73	40-56-80	47-61-86	53-65-92	59-73-103
24x24 36x16 48x12	Ac ft ²	CFM	750	116	1501	1877	2252	2628	3003	3754
	3.75	NC	14	15	16	18	20	23	25	32
	Throw		9-21-44	21-33-62	29-44-71	37-55-80	44-62-87	52-67-94	58-71-101	65-80-113
30x24 36x20	Ac ft ²	CFM	946	1297	1848	1999	2350	2701	3052	3754
	4.73	NC	15	16	17	19	21	23	26	33
	Throw		10-23-50	19-34-66	29-43-75	35-52-82	41-62-89	47-68-96	53-72-102	65-80-113
28x28	Ac ft ²	CFM	1030	1546	2061	2577	3093	3608	4124	5155
	5.15	NC	16	17	18	19	21	24	27	33
	Throw		11-24-52	24-39-72	34-52-83	43-65-93	52-72-102	60-78-110	68-83-118	76-93-132
36x24 48x18	Ac ft ²	CFM	1140	1709	2278	2846	3415	3984	4553	5690
	5.70	NC	16	17	18	20	22	24	27	34
	Throw		11-25-54	25-41-76	36-54-88	45-68-98	54-76-107	63-82-116	72-88-124	80-98-139
30x30	Ac ft ²	CFM	1190	1784	2378	2971	3565	4159	4753	5940
	5.95	NC	16	17	18	20	22	24	27	34
	Throw		12-26-56	26-42-78	37-56-90	46-69-100	56-78-110	65-84-119	73-90-127	82-100-142

SERIES XG-4000 PERFORMANCE DATA
MODELS XG-H/V4002, XG-H/V4004, XG-H/V4002M,
XG-H/V4002S, XG-H/V4004S, XG-H/V4002SM

Size		Nk Vel	200	300	400	500	600	700	800	1000
		Pt	.007	.015	.027	.042	.061	.083	.108	.169
32x30	Ac ft ²	CFM	1270	1905	2540	3175	3810	4445	5080	6350
	6.35	NC	17	18	19	21	23	25	28	34
	Throw		12-27-57	27-43-80	38-57-93	48-72-104	57-80-113	67-87-123	76-93-131	85-104-147
36x28 42x24	Ac ft ²	CFM	1330	1996	2663	3329	3995	4661	5328	6660
	6.65	NC	17	18	19	21	23	25	28	34
	Throw		12-27-59	27-44-82	39-59-95	49-73-106	59-82-116	69-89-126	77-95-134	87-106-150
36x30	Ac ft ²	CFM	1430	2146	2863	3579	4295	5011	5728	7160
	7.15	NC	17	18	19	21	23	25	28	35
	Throw		13-28-61	28-46-85	41-61-98	51-76-110	61-85-120	71-92-130	80-98-139	90-110-156
36x32 48x24 34x34	Ac ft ²	CFM	1525	2288	3051	3814	4578	5341	6104	7630
	7.63	NC	17	18	19	21	23	26	28	35
	Throw		13-29-63	29-47-88	42-63-102	52-79-114	63-88-124	73-95-134	83-102-144	93-114-161
36x36	Ac ft ²	CFM	1730	2593	3455	4318	5180	6043	6905	8630
	8.65	NC	18	19	20	22	24	26	29	35
	Throw		14-31-67	31-50-94	45-67-108	56-84-121	67-94-132	78-101-143	88-108-153	99-121-171
38x38	Ac ft ²	CFM	1930	2894	3858	4821	5785	6749	7713	9640
	9.65	NC	18	19	20	22	24	27	29	36
	Throw		15-33-71	33-53-99	47-71-114	59-88-128	71-99-140	83-107-151	93-114-161	104-128-181

PERFORMANCE NOTES FOR SERIES XG-4000

All data is tested in accordance with ANSI/ASHRAE 70-2006.

DEFINITION OF UNITS

CFM Air volume is cubic feet per minute

Nk Vel Neck Velocity is the airstream velocity in the duct just before it reaches the supply outlet; measured in feet per minute

fpm Velocity of air stream in Feet per Minute

Throw Throw distance in feet are for terminal velocities of 150 fpm, 100 fpm and 50 fpm respectively

NC Noise criterion, sound pressure level NC ratings are based on sound power level (Lw) re: 10⁻¹² watts minus a 10dB room attenuation in all octave bands

Pt Total pressures in inches of water

Ac Actual Core Free Area in square feet

SERIES XG-4000 PERFORMANCE DATA
**MODELS XG-H/V4002, XG-H/V4004, XG-H/V4002M,
 XG-H/V4002S, XG-H/V4004S, XG-H/V4002SM**

Size		Nk Vel	100	200	300	400	500	600	700	800
		Pt	.002	.007	.015	.027	.042	.061	.083	.108
42x36	Ac ft ²	CFM	1010	2020	3030	4040	5050	6060	7070	8080
	10.10	NC	15	18	19	21	22	24	27	29
	Throw		4-8-34	15-34-72	34-54-101	48-72-117	60-91-131	72-101-143	85-109-155	95-117-165
40x40	Ac ft ²	CFM	1070	2140	3210	4280	5350	6420	7490	8560
	10.70	NC	15	19	20	21	23	25	27	30
	Throw		4-9-35	15-35-75	35-56-104	50-75-120	62-93-134	75-104-147	87-113-159	98-120-170
48x36	Ac ft ²	CFM	1160	2316	3473	4629	5785	6941	8098	9254
	11.60	NC	15	19	20	21	23	25	27	30
	Throw		4-9-36	16-36-78	36-58-108	52-78-125	65-97-140	78-108-153	90-117-165	102-125-177
42x42	Ac ft ²	CFM	1180	2363	3545	4728	5910	7093	8275	9458
	11.80	NC	15	19	20	21	23	25	27	30
	Throw		4-9-37	16-37-78	37-59-109	52-78-126	65-98-141	78-109-155	91-118-167	103-126-179
44x44	Ac ft ²	CFM	1300	2599	3898	5196	6495	7794	9093	10391
	13.00	NC	16	20	21	22	24	26	28	31
	Throw		4-10-38	17-38-82	38-62-115	55-82-133	68-103-148	82-115-162	96-124-175	108-133-187
48x42	Ac ft ²	CFM	1360	2713	4065	5418	6770	8123	9475	10828
	13.60	NC	16	20	21	22	24	26	28	31
	Throw		4-10-40	17-39-84	39-63-117	56-84-135	70-105-151	84-117-166	98-127-179	110-135-191
46x46	Ac ft ²	CFM	1420	2843	4265	5688	7110	8533	9955	11378
	14.20	NC	16	20	21	22	24	26	28	31
	Throw		4-10-40	18-40-86	40-64-120	57-86-139	72-107-155	86-120-170	100-130-183	113-139-196
48x48	Ac ft ²	CFM	1550	3101	4653	6204	7755	9306	10858	12409
	15.50	NC	17	20	21	22	24	26	29	32
	Throw		5-10-42	19-42-90	42-67-125	60-90-145	75-112-162	90-125-177	105-135-192	118-145-205

PERFORMANCE NOTES FOR SERIES XG-4000

All data is tested in accordance with ANSI/ASHRAE 70-2006.

DEFINITION OF UNITS

CFM Air volume is cubic feet per minute

Nk Vel Neck Velocity is the airstream velocity in the duct just before it reaches the supply outlet; measured in feet per minute

fpm Velocity of air stream in Feet per Minute

Throw Throw distance in feet are for terminal velocities of 150 fpm, 100 fpm and 50 fpm respectively

NC Noise criterion, sound pressure level NC ratings are based on sound power level (Lw) re: 10⁻¹² watts minus a 10dB room attenuation in all octave bands

Pt Total pressures in inches of water

Ac Actual Core Free Area in square feet

MODEL XG-4000-AF

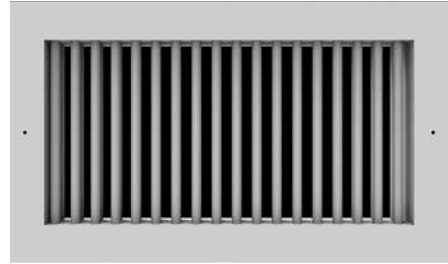

Model XG-4002-AF Single Deflection Airfoil Supply Grilles and Registers – Aluminum

XG-V4002-AF-1 – Surface Mount

XG-H4002-AF-1 – Surface Mount

XG-V4002-AF-6 – T-bar Lay-In

XG-H4002-AF-6 – T-bar Lay-In

Air Outlets shall be model XG-V4002-AF (vertical blades) or XG-H4002-AF (horizontal blades) manufactured by GREENHECK. Units shall be single deflection supply grilles of all extruded aluminum construction with an extruded aluminum border and deflection blades. The units shall be the size and quantity as outlined in the plans and specifications.

Border shall be 1 1/4" wide with airfoil shaped deflector blades on .666" centers. Deflector blades shall be individually adjustable. Blades shall pivot in friction mounting retainers. Retainers shall hold the deflector blade position throughout the specified operating range of the device.

Metal friction wires are not acceptable.

Model XG-4004-AF

Double Deflection Airfoil Supply Grilles and Registers – Aluminum

XG-V4004-AF-1 – Surface Mount

XG-H4004-AF-1 – Surface Mount

XG-V4004-AF-6 – T-bar Lay-In

XG-H4004-AF-6 – T-bar Lay-In

Air Outlets shall be model XG-V4004-AF (vertical front blades) or XG-H4004-AF (horizontal front blades) manufactured by GREENHECK. Units shall be double deflection supply grilles of all extruded aluminum construction and with an extruded border with front and rear sets of deflection blades. The units shall be the size and quantity as outlined in the plans and specifications.

Border shall be 1 1/4" wide with airfoil shaped deflector blades on .666" centers. Deflector blades shall be individually adjustable. Blades shall pivot in friction mounting retainers. Retainers shall hold the deflector blade position throughout the specified operating range of the device.

Metal friction wires are not acceptable.

Model XG-4002S-AF**Single Deflection Airfoil Supply Grilles and Registers – Steel****XG-V4002S-AF-1 – Surface Mount****XG-H4002S-AF-1 – Surface Mount****XG-V4002S-AF-6 – T-bar Lay-In****XG-H4002S-AF-6 – T-bar Lay-In**

Air Outlets shall be model XG-V4002S-AF (vertical blades) or XG-H4002S-AF (horizontal blades) manufactured by GREENHECK. Units shall be single deflection supply grilles of all steel construction. The units shall be the size and quantity as outlined in the plans and specifications.

Border shall be 1 1/4" wide with airfoil shaped deflector blades on .666" centers. Deflector blades shall be individually adjustable. Blades shall pivot in friction mounting retainers. Retainers shall hold the deflector blade position throughout the specified operating range of the device.

Metal friction wires are not acceptable.

Model XG-4004S-AF**Double Deflection Airfoil Supply Grilles and Registers – Steel****XG-V4004S-AF-1 – Surface Mount****XG-H4004S-AF-1 – Surface Mount****XG-V4004S-AF-6 – T-bar Lay-In****XG-H4004S-AF-6 – T-bar Lay-In**

Air Outlets shall be model XG-V4004S-AF (vertical front blades) or XG-H4004S-AF (horizontal front blades) manufactured by GREENHECK. Units shall be double deflection supply grilles of all steel construction. The units shall be the size and quantity as outlined in the plans and specifications.

Border shall be 1 1/4" wide with airfoil shaped deflector blades on .666" centers. Deflector blades shall be individually adjustable. Blades shall pivot in friction mounting retainers. Retainers shall hold the deflector blade position throughout the specified operating range of the device.

Metal friction wires are not acceptable.

For Surface mounting:

Units shall be designed for surface mounting applications and be provided with counter sunk screw holes on the face of the device.

For T-Bar Lay-in:

Units shall be designed to integrate into the specified ceiling system.

Damper Accessories (Optional):

Optional opposed blade damper shall be constructed of steel (model XG-OB) or aluminum (model XG-OBDA). Damper must be operable from the face of the diffuser.

Performance Specification:

The manufacturer shall provide published performance data. Data shall be tested in accordance to ANSI/ASHRAE Standard 70- 2006

Paint Specification

Process shall be anodic electrodeposition using an anodic acrylic paint. Units shall undergo pre- treatment including a pressurized spray stage using an alkaline cleaner and a de-ionized water rinse.

MODEL XG-4002-AF

Sidewall Supply Grilles and Registers - Air Foil Series Extruded Aluminum - Single Deflection

Models: **XG-H4002-AF-1** Single Deflection Grille - Horizontal Blades
XG-V4002-AF-1 Single Deflection Grille - Vertical Blades
XG-H4002-AF-1 XG-OBD Single Deflection Register - Horizontal Blades - with opposed Blade Damper
XG-V4002-AF-1 XG-OBD Single Deflection Register - Vertical Blades - with opposed Blade Damper

Model: **XG-H4002-AF-1 - Single Deflection Grille With Horizontal Blades**

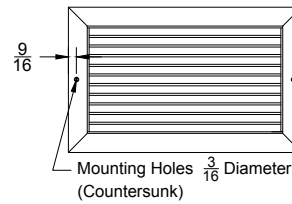
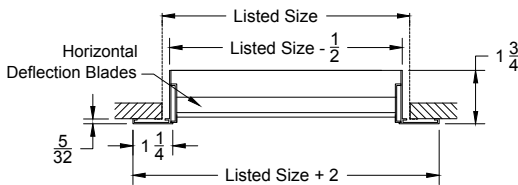

**Front View
(Horizontal Blades)**

Model: **XG-V4002-AF-1 - Single Deflection Grille With Vertical Blades**

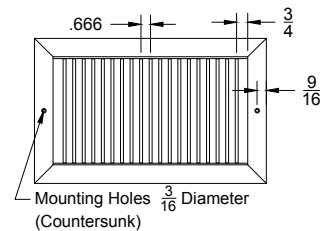
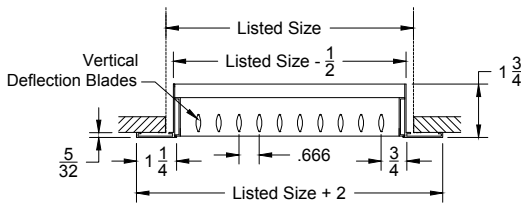

**Front View
(Vertical Blades)**

Model: **XG-H4002-AF-1 XG-OBD - Single Deflection Register With Opposed Blade Damper - With Horizontal Blades**

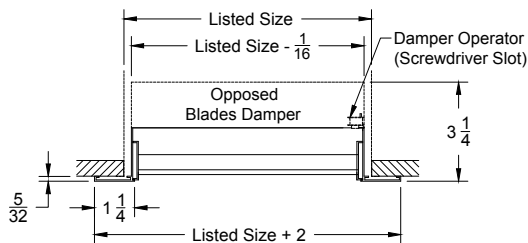

Model: **XG-V4002-AF-1 XG-OBD - Single Deflection Register With Opposed Blade Damper - With Vertical Blades**

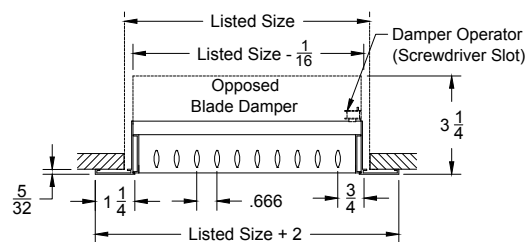

MODEL XG-4002-AF

Sidewall Supply Grilles and Registers - Air Foil Series Extruded Aluminum - Single Deflection

Models: **XG-V4002-AF-6** Single Deflection Grille - Vertical Blades - Lay In T-Bar
XG-H4002-AF-6 Single Deflection Grille - Horizontal Blades - Lay In T-Bar

Model: **XG-H4002-AF-6 Lay In T-Bar - Single Deflection Grille With Horizontal Blades**

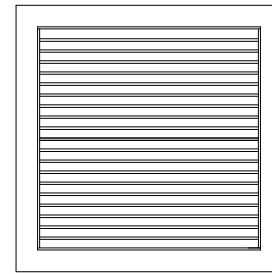
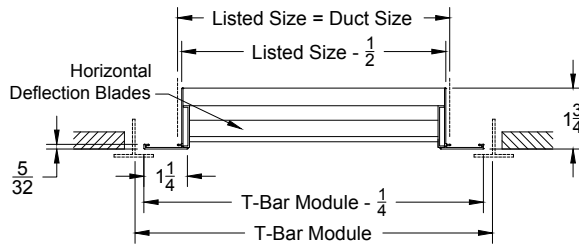

**Front View
(Horizontal Blades)**

Model: **XG-V4002-AF-6 Lay In T-Bar - Single Deflection Grille With Vertical Blades**

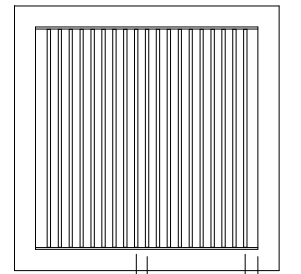
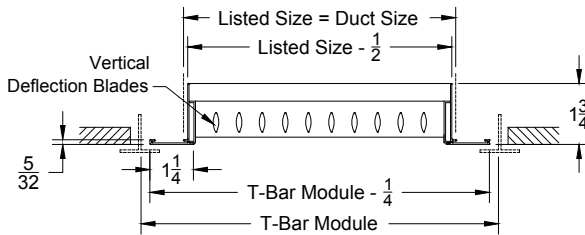

**Front View
(Vertical Blades)**

Notes: (check if provided)

1. Available Finishes	2. Available Accessories	3. Available Options	4. Construction Details
Standard Finish: <input type="checkbox"/> 01 White. Optional Finish (no extra charge): <input type="checkbox"/> 24 Mill Finish. Optional Finish (extra Charge): <input type="checkbox"/> 02 Satin Silver <input type="checkbox"/> 03 Black. <input type="checkbox"/> 04 Clear Anodized / Setup Charge <input type="checkbox"/> 28 Custom Color / Setup Charge	<input type="checkbox"/> XG-OBD - Steel Opposed Blade Damper. <input type="checkbox"/> XG-OBDA - Aluminum Opposed Blade Damper <input type="checkbox"/> XG-L9 - Equalizing Grid. <input type="checkbox"/> XG-PF - Plaster Frame. <input type="checkbox"/> XG-TBPF - T-Bar Plaster Frame TR - Transition Square / Rectangular to Round up to 22x22 <input type="checkbox"/> XG-TR - Deep Transition Used with Dampers <input type="checkbox"/> IS - Insect Screen <input type="checkbox"/> XG-LIPF - Lay-In Plaster Frame <input type="checkbox"/> NSH - No Screw Holes		<ul style="list-style-type: none"> Extruded aluminum border and blades. Oversized units made in multiple sections, each with full flanges. Mullion strips provided for joining units in field.

MODEL XG-4002S-AF

Sidewall Supply Grilles and Registers - Air Foil Series Steel Border/Blades Extruded Aluminum - Single Deflection

Models: **XG-V4002S-AF-1** Single Deflection Grille - Vertical Blades
XG-H4002S-AF-1 Single Deflection Grille - Horizontal Blades
XG-V4002S-AF-1 XG-OBD Single Deflection Grille - Vertical Blades - with Opposed Blade Damper
XG-H4002S-XG-AF-1 XG-OBD Single Deflection Grille - Horizontal Blades - with Opposed Blade Damper

Model: **XG-H4002S-AF-1 - Single Deflection Grille With Horizontal Blades**

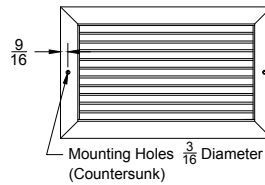
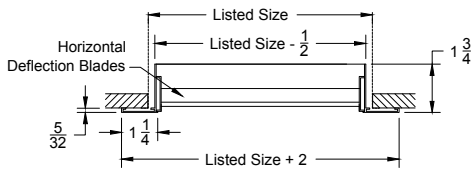

**Front View
(Horizontal Blades)**

Model: **XG-V4002S-AF-1 - Single Deflection Grille With Vertical Blades**

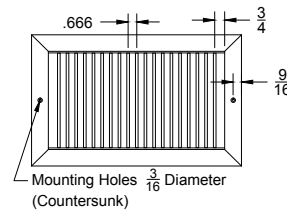
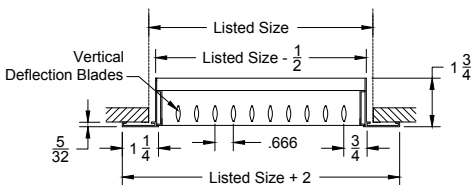

**Front View
(Vertical Blades)**

Model: **XG-H4002S-AF-1 XG-OBD - Single Deflection Register With Opposed Blade Damper - With Horizontal Blades**

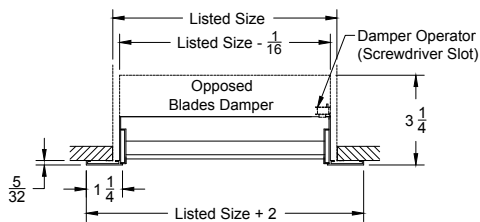

Model: **XG-V4002S-AF-1 XG-OBD - Single Deflection Register With Opposed Blade Damper - With Vertical Blades**

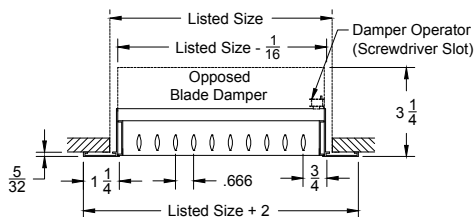

MODEL XG-4002S-AF

Sidewall Supply Grilles and Registers - Air Foil Series Steel Border/Blades Extruded Aluminum - Single Deflection

Models: **XG-V4002S-AF-6** Single Deflection Grille - Vertical Blades - Lay In T-Bar
XG-H4002S-AF-6 Single Deflection Grille - Horizontal Blades - Lay In T-Bar

Model: XG-H4002S-AF-6 Lay In T-Bar - Single Deflection Grille With Horizontal Blades

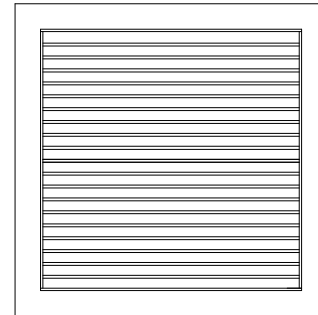
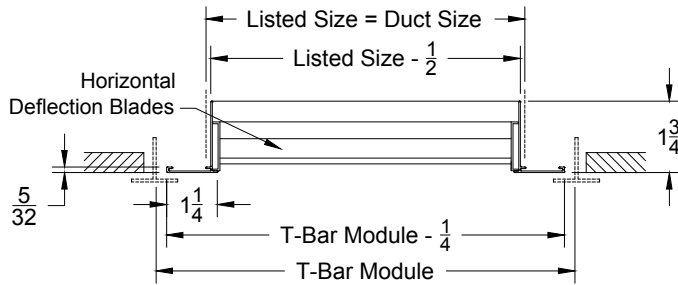

**Front View
(Horizontal Blades)**

Model: XG-V4002S-AF-6 Lay In T-Bar - Single Deflection Grille With Vertical Blades

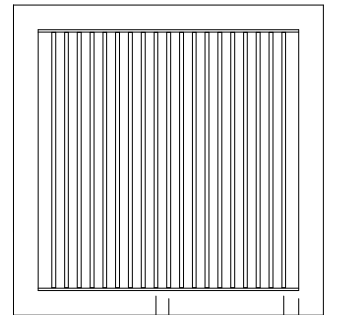
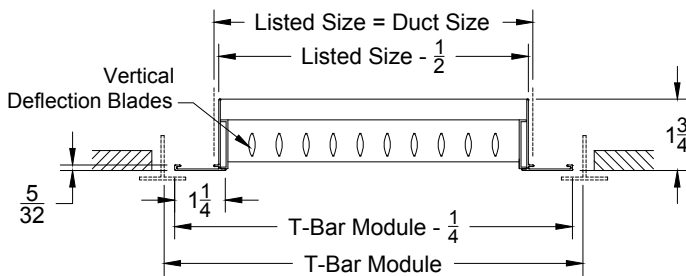

**Front View
(Vertical Blades)**

Notes: (check if provided)

1. Available Finishes	2. Available Accessories	3. Options	4. Construction Details
<p>Standard Finish:</p> <p><input type="checkbox"/> 01 White.</p> <p>Optional Finish (no additional charge):</p> <p><input type="checkbox"/> 02 Satin Silver</p> <p><input type="checkbox"/> 03 Black</p> <p><input type="checkbox"/> 28 Custom Color / Setup Charge</p>	<p><input type="checkbox"/> XG-OBDA - Steel Opposed Blade Damper.</p> <p><input type="checkbox"/> XG-OBDA - Aluminum Opposed Blade Damper.</p> <p><input type="checkbox"/> XG-L9 - Equalizing Grid.</p> <p><input type="checkbox"/> XG PF - Plaster Frame.</p> <p><input type="checkbox"/> XG-TR - Transition Square / Rectangular To Round Up to 22x 22</p> <p><input type="checkbox"/> XG-TR - Deep Transition Used with Damper</p> <p><input type="checkbox"/> IS - Insect Screen</p> <p><input type="checkbox"/> XG-LIPF - Lay-In Plaster Frame</p> <p><input type="checkbox"/> NSH - No Screw Hole</p>		<ul style="list-style-type: none"> Extruded aluminum air foil blades and steel border. Oversized units made in multiple sections, each with full flanges. Mullion strips provided for joining units in field.

MODEL XG-4004-AF-1

Sidewall Supply Grilles and Registers Air Foil Series - Extruded Aluminum - Double Deflection

- Models: **XG-V4004-AF-1** Double Deflection Grille - Vertical Front Blades
XG-H4004-AF-1 Double Deflection Grille - Horizontal Front Blades
XG-H4004-AF-1-XG-OBD Double Deflection Register - Horizontal Front Blades - with Opposed Blade Damper
XG-V4004-AF-1-XG-OBD Double Deflection Register - Vertical Front Blades - with Opposed Blade Damper

Model: XG-H4004-AF-1 (Double Deflection Grille)
(Horizontal Front Blades)

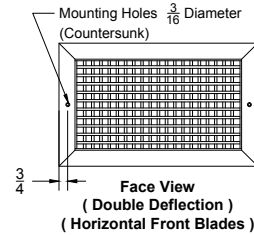
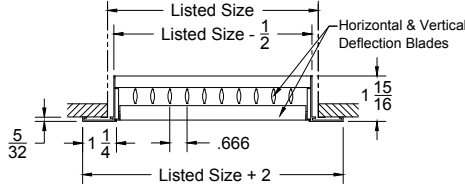

Model: XG-V4004-AF-1 (Double Deflection Grille)
(Vertical Front Blades)

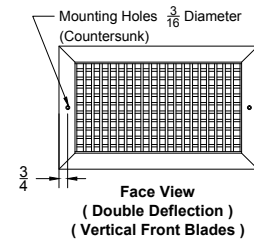
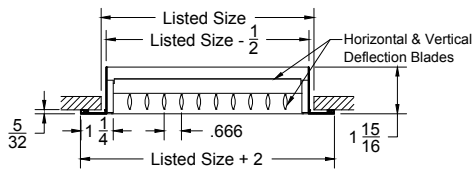

Model: XG-H4004-AF-1 XG-OBD (Double Deflection Register)
(Horizontal Front Blades)
With Opposed Blade Damper

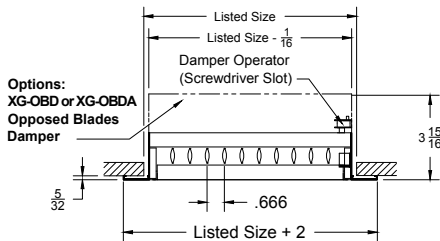

Model: XG-V4004-AF-1 XG-OBD (Double Deflection Register)
(Vertical Front Blades)
With Opposed Blade Damper

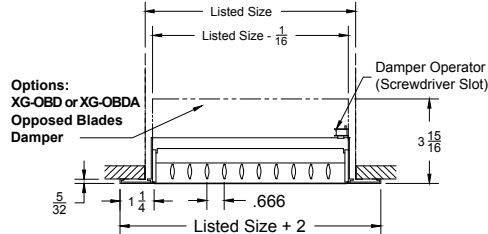

Notes: (check if provided)

1. Available Finishes	2. Available Accessories	3. Available Options	4. Construction Details
Standard Finish: <input type="checkbox"/> 01 White. Optional Finish (no extra charge): <input type="checkbox"/> 24 Mill Finish. Optional Finish (extra Charge): <input type="checkbox"/> 02 Satin Silver <input type="checkbox"/> 03 Black. <input type="checkbox"/> 04 Clear Anodized / Setup Charge <input type="checkbox"/> 28 Custom Color / Setup Charge	<input type="checkbox"/> XG-OBD - Steel Opposed Blade Damper. <input type="checkbox"/> XG-OBDA - Aluminum Opposed Blade Damper. <input type="checkbox"/> XG-PF - Plaster Frame <input type="checkbox"/> XG-TBPF - T-Bar Plaster Frame <input type="checkbox"/> XG-TR - Transition Square / Rectangular to Round Up to 22x22 <input type="checkbox"/> XG-TRD - Deep Transition Used with Dampers <input type="checkbox"/> XG-IS - Insect Screen <input type="checkbox"/> XG-LIPF - Lay-In Plaster Frame	<input type="checkbox"/> NSH No Screen Holes	<ul style="list-style-type: none"> ● Extruded Aluminum border and blades. ● Oversized units made in multiple sections, each with full flanges. Mullion strips provided for joining units in field.

MODEL XG-4004S-AF-1

Sidewall Supply Grille and Registers Steel Border Extruded Aluminum Blades - Double Deflection

Models: **XG-V4004S-AF-1** Double Deflection Grille - Vertical Front Blades
XG-H4004S-AF-1 Double Deflection Grille - Horizontal Front Blades

Model: **XG-V4004S-AF-1 (Double Deflection Grille - Vertical Front Blades) Front View (Double Deflection) (Vertical Front Blades)**

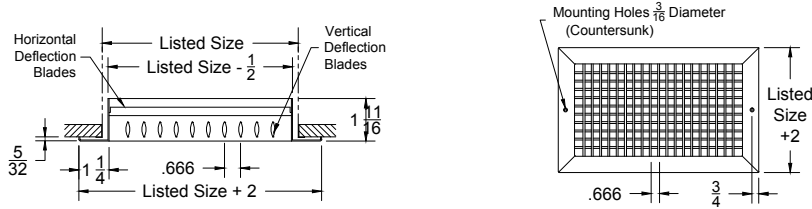

Model: **XG-H4004S-AF-1 (Double Deflection Grille - Horizontal Front Blades) Front View (Double Deflection) (Horizontal Front Blades)**

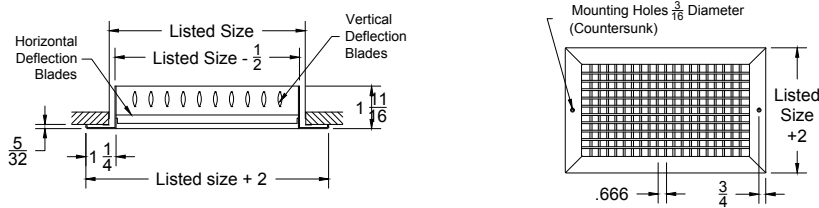

Option: **XG-H4004S-AF-1-XG-OBD (Double Deflection Register) (Horizontal Front Blades) With Opposed Blade Damper**

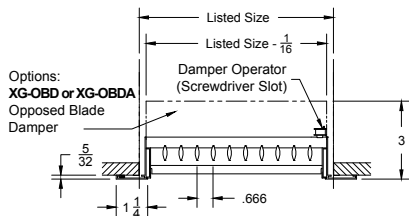

Option: **XG-V4004S-AF-1-XG-OBD (Double Deflection Register) (Vertical Front Blades) With Opposed Blade Damper**

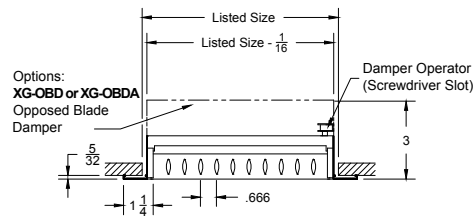

SERIES XG-4000 PERFORMANCE DATA
MODELS XG-H/V4002-AF, XG-H/V4004-AF, XG-H/V4002S-AF, XG-H/V4004S-AF

Size	Nk Vel		200	300	400	500	600	700	800	1000
	Pt		.007	.015	.027	.042	.061	.083	.108	.169
06x04	Ac ft ²	CFM	24	36	48	60	72	84	96	120
	0.17	NC	-	-	-	-	-	-	11	18
	Throw		2-4-8	4-6-11	5-8-13	7-10-14	8-11-16	9-12-17	10-13-18	12-14-20
06x06	Ac ft ²	CFM	38	57	76	95	114	133	152	190
	0.25	NC	-	-	-	-	-	10	13	20
	Throw		4-8-17	7-12-21	10-15-24	12-17-26	14-20-28	15-21-30	17-23-32	19-24-34
08x08 10x06 12x05	Ac ft ²	CFM	73	110	146	183	219	256	292	365
	0.42	NC	-	-	-	-	11	13	16	22
	Throw		3-6-14	6-10-19	9-14-22	11-17-25	14-19-27	16-21-29	18-22-31	20-25-35
12x06	Ac ft ²	CFM	82	123	164	205	246	287	328	410
	0.50	NC	-	-	-	11	11	13	16	23
	Throw		3-7-15	7-11-20	10-15-24	12-18-26	15-20-29	17-22-31	19-24-33	21-26-37
10x08 14x6	Ac ft ²	CFM	93	140	186	233	279	326	372	465
	0.56	NC	-	-	-	10	12	14	17	23
	Throw		3-7-16	7-12-22	10-16-25	13-19-28	16-22-31	18-23-33	20-25-35	23-28-40
10x10 12x08 16x06	Ac ft ²	CFM	118	172	140	195	357	414	478	592
	0.69	NC	-	-	-	11	13	15	18	24
	Throw		4-8-18	8-13-25	12-18-28	15-22-32	18-25-35	20-27-37	23-28-40	26-32-45
14x08 18x06	Ac ft ²	CFM	134	201	267	335	394	468	534	661
	0.67	NC	-	-	-	11	13	15	18	25
	Throw		4-9-19	9-14-26	13-20-30	16-23-34	19-26-37	23-29-41	25-30-42	27-34-47
12x10 20x06	Ac ft ²	CFM	145	218	290	363	435	509	582	729
	0.83	NC	-	-	10	11	13	16	18	25
	Throw		4-9-19	9-15-27	13-19-31	16-24-35	19-27-38	23-29-41	26-31-44	29-35-49
16x08 22x06	Ac ft ²	CFM	153	230	306	383	459	536	612	765
	0.89	NC	-	-	10	12	14	16	19	25
	Throw		4-9-20	9-15-28	13-20-32	17-25-36	20-28-39	23-30-43	26-32-46	29-36-51
14x10 28x05	Ac ft ²	CFM	170	255	340	425	510	595	680	850
	0.85	NC	-	-	10	12	14	16	19	26
	Throw		4-10-21	10-16-29	14-21-34	18-26-38	21-29-42	25-32-45	28-34-48	31-38-54
12x12 24x06 18x08	Ac ft ²	CFM	176	263	351	439	527	615	701	878
	0.88	NC	-	-	10	12	14	16	19	26
	Throw		8-19-38	14-25-46	21-31-51	25-37-56	29-43-60	33-46-64	37-48-68	41-51-72
30x06 18x10	Ac ft ²	CFM	213	320	426	533	640	746	853	1066
	1.07	NC	-	10	11	13	15	17	20	27
	Throw		5-11-24	11-18-33	16-24-38	20-29-42	24-33-46	27-36-50	31-38-54	35-42-60

SERIES XG-4000 PERFORMANCE DATA

MODELS XG-H/V4002-AF, XG-H/V4004-AF, XG-H/V4002S-AF, XG-H/V4004S-AF

Size		Nk Vel	200	300	400	500	600	700	800	1000
		Pt	.007	.015	.027	.042	.061	.083	.108	.169
14x14	Ac ft ²	CFM	244	366	488	610	732	853	975	1219
	1.22	NC	-	10	12	13	15	18	21	27
	Throw			5-12-25	12-19-35	17-25-41	21-31-45	25-35-50	29-38-54	33-41-57
36x06 18x12	Ac ft ²	CFM	257	366	514	643	771	900	1028	1285
	1.29	NC	10	11	12	14	16	18	21	28
	Throw			5-12-26	12-19-36	17-26-42	22-32-47	26-36-51	30-39-55	34-42-59
22x10	Ac ft ²	CFM	273	410	546	683	819	956	1092	1385
	1.37	NC	10	11	12	14	16	18	21	28
	Throw			6-12-27	12-20-37	18-27-43	22-33-48	27-37-53	31-40-57	35-43-61
30x08 24x10	Ac ft ²	CFM	295	442	589	736	884	1031	1178	1472
	1.48	NC	10	11	13	14	16	19	21	28
	Throw			6-13-28	13-21-39	18-28-45	23-35-50	28-39-55	32-42-59	36-45-63
16x16	Ac ft ²	CFM	323	485	646	808	969	1131	1292	1615
	1.62	NC	11	12	13	15	17	19	22	28
	Throw			6-14-29	14-22-40	19-29-47	24-36-52	29-40-57	34-44-62	38-47-66

PERFORMANCE NOTES FOR SERIES XG-4000

All data is tested in accordance with ANSI/ASHRAE 70-2006.

DEFINITION OF UNITS

CFM Air volume is cubic feet per minute

Nk Vel Neck Velocity is the airstream velocity in the duct just before it reaches the supply outlet; measured in feet per minute

fpm Velocity of air stream in Feet per Minute

Throw Throw distance in feet are for terminal velocities of 150 fpm, 100 fpm and 50 fpm respectively

NC Noise criterion, sound pressure level NC ratings are based on sound power level (Lw) re: 10⁻¹² watts minus a 10dB room attenuation in all octave bands

Pt Total pressures in inches of water

Ac Actual Core Free Area in square feet

SERIES XG-4000 PERFORMANCE DATA
MODELS XG-H/V4002-AF, XG-H/V4004-AF, XG-H/V4002S-AF, XG-H/V4004S-AF

Size	Nk Vel		200	300	400	500	600	700	800	1000
	Pt		.007	.015	.027	.042	.061	.083	.108	.169
24x12	Ac ft ²	CFM	364	546	727	909	1090	1272	1453	1816
	1.82	NC	11	12	13	15	17	20	22	29
36x08	Throw		6-13-30	14-23-43	20-31-50	26-38-55	31-43-61	36-46-66	40-50-70	45-55-78
48x06	Ac ft ²	CFM	414	621	87	1034	1240	1447	1653	2066
	2.07	NC	12	13	14	16	18	20	23	29
	Throw		7-15-33	15-25-46	22-33-53	27-41-59	33-46-65	38-49-70	43-53-75	48-59-84
18x18	Ac ft ²	CFM	456	685	914	1142	1371	1600	1829	2386
	2.28	NC	12	13	14	16	18	20	23	30
	Throw		7-16-34	16-26-48	23-34-56	29-43-62	34-48-68	40-52-74	45-56-79	51-62-88
30x12	Ac ft ²	CFM	515	772	1030	1287	1545	1802	2059	2574
	2.59	NC	13	14	15	17	19	21	24	30
	Throw		8-17-37	17-27-51	24-37-59	30-46-66	37-51-72	43-55-78	48-59-83	54-66-93
20x20	Ac ft ²	CFM	550	826	1101	1377	1653	1928	2204	2755
	2.75	NC	13	14	15	17	19	21	24	31
	Throw		8-18-38	18-28-53	25-38-61	32-47-68	38-53-75	44-57-81	50-61-86	56-68-96
24x18	Ac ft ²	CFM	626	940	1254	1567	1881	2195	2509	3136
	3.13	NC	13	14	16	17	19	22	25	31
	Throw		8-19-40	19-30-56	27-40-65	34-50-73	40-56-80	47-61-86	53-65-92	59-73-103
24x20	Ac ft ²	CFM	750	1125	1501	1877	2252	2628	3003	3754
	3.75	NC	14	15	16	18	20	23	25	32
	Throw		9-21-44	21-33-62	29-44-71	37-55-80	44-62-87	52-67-94	58-71-101	65-80-113
48x10	Ac ft ²	CFM	946	1297	1848	1999	2350	2701	3052	3754
	4.73	NC	15	16	17	19	21	23	26	33
	Throw		10-23-50	19-34-66	29-43-75	35-52-82	41-62-89	47-68-96	53-72-102	65-80-113
28x28	Ac ft ²	CFM	1030	1546	2061	2577	3093	3608	4124	5155
	5.15	NC	16	17	18	19	21	24	27	33
	Throw		11-24-52	24-39-72	34-52-83	43-65-93	52-72-102	60-78-110	68-83-118	76-93-132
36x24	Ac ft ²	CFM	1140	1709	2278	2846	3415	3984	4553	5690
	5.70	NC	16	17	18	20	22	24	27	34
	Throw		11-25-54	25-41-76	36-54-88	45-68-98	54-76-107	63-82-116	72-88-124	80-98-139
48x18	Ac ft ²	CFM	1190	1784	2378	2971	3565	4159	4753	5940
	5.95	NC	16	17	18	20	22	24	27	34
	Throw		12-26-56	26-42-78	37-56-90	46-69-100	56-78-110	65-84-119	73-90-127	82-100-142
30x30	Ac ft ²	CFM	1270	1905	2540	3175	3810	4445	5080	6350
	6.35	NC	17	18	19	21	23	25	28	34
	Throw		12-27-57	27-43-80	38-57-93	48-72-104	57-80-113	67-87-123	76-93-131	85-104-147

CONTINUED

SERIES XG-4000 PERFORMANCE DATA

MODELS XG-H/V4002-AF, XG-H/V4004-AF, XG-H/V4002S-AF, XG-H/V4004S-AF

Size	Nk Vel	Pt	200	300	400	500	600	700	800	1000
			.007	.015	.027	.042	.061	.083	.108	.169
36x28 42x24	Ac ft ²	CFM	1330	1996	2663	3329	3995	4661	5328	6660
	6.65	NC	17	18	19	21	23	25	28	34
	Throw		12-27-59	27-44-82	39-59-95	49-73-106	59-82-116	69-89-126	77-95-134	87-106-150
36x30	Ac ft ²	CFM	1430	2146	2863	3579	4295	5011	5728	7160
	7.15	NC	17	18	19	21	23	25	28	35
	Throw		13-28-61	28-46-85	41-61-98	51-76-110	61-85-120	71-92-130	80-98-139	90-110-156
36x32 48x24	Ac ft ²	CFM	1525	2288	3051	3814	4578	5341	6104	7630
	7.63	NC	17	18	19	21	23	26	28	35
	Throw		13-29-63	29-47-88	42-63-102	52-79-114	63-88-124	73-95-134	83-102-144	93-114-161
34x34	Ac ft ²	CFM	1730	2593	3455	4318	5180	6043	6905	8630
	8.65	NC	18	19	20	22	24	26	29	35
	Throw		14-31-67	31-50-94	45-67-108	56-84-121	67-94-132	78-101-143	88-108-153	99-121-171
36x36	Ac ft ²	CFM	1930	2894	3858	4821	5785	6749	7713	9640
	9.65	NC	18	19	20	22	24	27	29	36
	Throw		15-33-71	33-53-99	47-71-114	59-88-128	71-99-140	83-107-151	93-114-161	104-128-181

PERFORMANCE NOTES FOR SERIES XG-4000

All data is tested in accordance with ANSI/ASHRAE 70-2006.

DEFINITION OF UNITS

CFM Air volume is cubic feet per minute

Nk Vel Neck Velocity is the airstream velocity in the duct just before it reaches the supply outlet; measured in feet per minute

fpm Velocity of air stream in Feet per Minute

Throw Throw distance in feet are for terminal velocities of 150 fpm, 100 fpm and 50 fpm respectively

NC Noise criterion, sound pressure level NC ratings are based on sound power level (Lw) re: 10⁻¹² watts minus a 10dB room attenuation in all octave bands

Pt Total pressures in inches of water

Ac Actual Core Free Area in square feet

SERIES XG-4000 PERFORMANCE DATA
MODELS XG-H/V4002-AF, XG-H/V4004-AF, XG-H/V4002S-AF, XG-H/V4004S-AF

Size	Nk Vel	Pt	100	200	300	400	500	600	700	800
			.002	.007	.015	.027	.042	.061	.083	.108
42x36	Ac ft ² 10.10	CFM	1010	2020	3030	4040	5050	6060	7070	8080
		NC	15	18	19	21	22	24	27	29
	Throw	4-8-34	15-34-72	34-54-101	48-72-117	60-91-131	72-101-143	85-109-155	95-117-165	
40x40	Ac ft ² 10.70	CFM	1070	2140	3210	4280	5350	6420	7490	8560
		NC	15	19	20	21	23	25	27	30
	Throw	4-9-35	15-35-75	35-56-104	50-75-120	62-93-134	75-104-147	87-113-159	98-120-170	
48x36	Ac ft ² 11.60	CFM	1160	2316	3473	4629	5785	6941	8098	9254
		NC	15	19	20	21	23	25	27	30
	Throw	4-9-36	16-36-78	36-58-108	52-78-125	65-97-140	78-108-153	90-117-165	102-125-177	
42x42	Ac ft ² 11.80	CFM	1180	2363	3545	4728	5910	7093	8275	9458
		NC	15	19	20	21	23	25	27	30
	Throw	4-9-37	16-37-78	37-59-109	52-78-126	65-98-141	78-109-155	91-118-167	103-126-179	
44x44	Ac ft ² 13.00	CFM	1300	2599	3898	5196	6495	7794	9093	10391
		NC	16	20	21	22	24	26	28	31
	Throw	4-10-38	17-38-82	38-62-115	55-82-133	68-103-148	82-115-162	96-124-175	108-133-187	
48x42	Ac ft ² 13.60	CFM	1360	2713	4065	5418	6770	8123	9475	10828
		NC	16	20	21	22	24	26	28	31
	Throw	4-10-40	17-39-84	39-63-117	56-84-135	70-105-151	84-117-166	98-127-179	110-135-191	
46x46	Ac ft ² 14.20	CFM	1420	2843	4265	5688	7110	8533	9955	11378
		NC	16	20	21	22	24	26	28	31
	Throw	4-10-40	18-40-86	40-64-120	57-86-139	72-107-155	86-120-170	100-130-183	113-139-196	
48x48	Ac ft ² 15.50	CFM	1550	3101	4653	6204	7755	9306	10858	12409
		NC	17	20	21	22	24	26	29	32
	Throw	5-10-42	19-42-90	42-67-125	60-90-145	75-112-162	90-125-177	105-135-192	118-145-205	

PERFORMANCE NOTES FOR SERIES XG-4000
All data is tested in accordance with ANSI/ASHRAE 70-2006.
DEFINITION OF UNITS
CFM Air volume is cubic feet per minute
Nk Vel Neck Velocity is the airstream velocity in the duct just before it reaches the supply outlet; measured in feet per minute
fpm Velocity of air stream in Feet per Minute
Throw Throw distance in feet are for terminal velocities of 150 fpm, 100 fpm and 50 fpm respectively
NC Noise criterion, sound pressure level NC ratings are based on sound power level (Lw) re: 10⁻¹² watts minus a 10dB room attenuation in all octave bands
Pt Total pressures in inches of water
Ac Actual Core Free Area in square feet

MODEL XG-L



Supply - Curved Blade Grilles – Aluminum/Model XG-L – Long Blades/Model XG-S – Short Blades

Air Outlets shall be model XG-L (long blades) or XG-S (short blades) manufactured by GREENHECK. Units shall be curved blade supply grilles of aluminum construction and with an extruded aluminum border and curved deflection blades.

Rear Deflection Blades (Optional)

Outlets shall include rear deflection blades adjustable from the face (1-way model XG-XG-LV-1 or XG-SV-1 or 2-way model XG-XG-LTV-1 or XG-XG-STH-1). Units shall be available in 1, 2, 3, or 4 way directional patterns. Pattern shall be adjustable from full horizontal to vertical. The units shall be the size and quantity as outlined in the plans and specifications.

Border shall be 1 1/4" wide with aerodynamically shaped deflector blades on .9" center. Deflector blades shall be individually adjustable. Units shall be designed for surface mounting applications and be provided with screw holes on the face of the device. Blades shall pivot in friction mounting retainers. Retainers shall hold the deflector blade position throughout the specified operating range of the device. Metal friction wires are not acceptable.

Damper Accessories (Optional)

1. Optional opposed blade damper shall be constructed of steel (Model XG-OBD) or aluminum (Model XG-OBDA).
2. Damper must be operable from the face of the diffuser.
3. An integral multi-shutter damper shall be provided. Damper shall be operated from the face of the diffuser.
4. An integral multi-shutter damper shall be provided (1-way model XG-LMH-1 or 2-way opposite model XG-LTMH-1). Damper handle shall protrude through the border of the grille.

Performance Specification

The manufacturer shall provide published performance data. Data shall be tested in accordance to ANSI/ASHRAE Standard 70- 2006.

MODEL XG-L

Supply Curved Blade Ceiling Grilles / Registers Aluminum - Single Deflection Supply - Surface Mount

- Models: **XG-L-1** Single Deflection Supply Grille - One Way - Long Blades
XG-S-1 Single Deflection Supply Grille - One Way - Short Blades
XG-LT-1 Single Deflection Supply Grille - Two Way - Long Blades
XG-ST-1 Single Deflection Supply Grille - Two Way - Short Blades
XG-LTC-1 Single Deflection Supply Grille - Two Way Corner Blow Pattern
XG-LTC3-1 Single Deflection Supply Grille - Three Way Corner Blow Pattern
XG-LS3-1 Single Deflection Supply Grille - Three Way Blow Pattern
XG-LS4-1 Single Deflection Supply Grille - Four Way Blow Pattern

- Models: **XG-L-1 (One Way - Long Blades - Surface Mount)**
 XG-S-1 (One Way - Short Blades - Surface Mount)

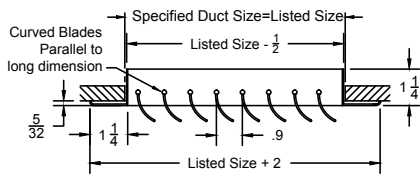

Face View (XG-L-1 Model)

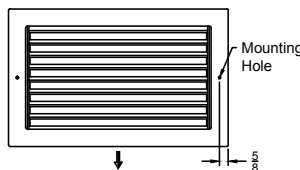

Face View (XG-S-1 Model)

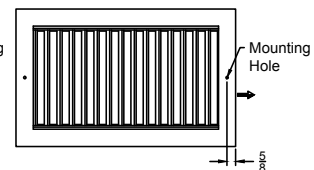

- Models: **XG-LT-1 (Two Way - Long Blades - Surface Mount)**
 XG-T-1 (Two Way - Short Blades - Surface Mount)

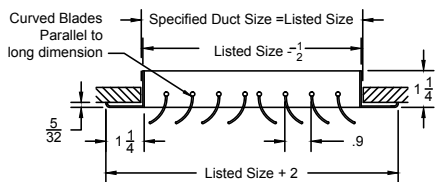

Face View (XG-LT-1 Model)

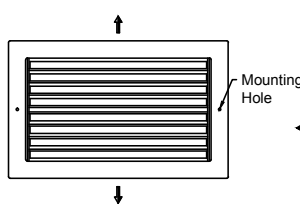

Face View (XG-ST-1 Model)

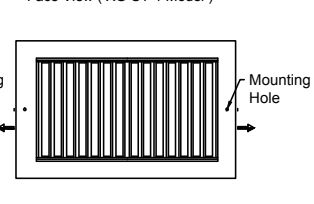

- Models: **XG-LTC-1 (Two Way Corner Blow Pattern - Surface Mount)**
 XG-LTC3-1 (Three Way Corner Blow Pattern - Surface Mount)

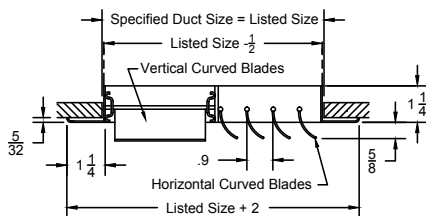

Face View (XG-LTC-1 Model)

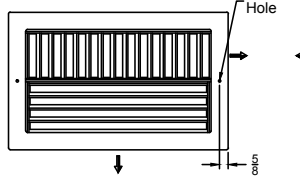

Face View (XG-LTC3-1 Model)

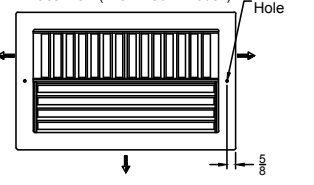

- Models: **XG-LS3-1 (Three Way Blow Pattern - Surface Mount)**
 XG-LS4-1 (Four Way Blow Pattern - Surface Mount)

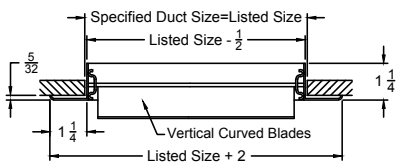

Face View (XG-LS3-1 Model)

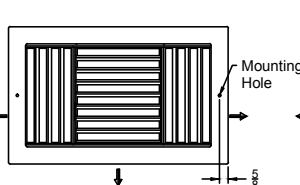

Face View (XG-LS4-1 Model)

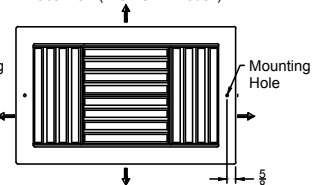

Note: Arrow shows air blow way.

MODEL XG-L

Supply Curved Blade Ceiling Grilles / Registers Aluminum - Single Deflection Supply - Lay In T-Bar

- Models: **XG-L-6** Single Deflection Supply Grille - One Way - Long Blades - Lay In T-Bar
XG-S-6 Single Deflection Supply Grille - One Way - Short Blades - Lay In T-Bar
XG-LT-6 Single Deflection Supply Grille - Two Way - Long Blades - Lay In T-Bar
XG-ST-6 Single Deflection Supply Grille - Two Way - Short Blades - Lay In T-Bar
XG-LTC-6 Single Deflection Supply Grille - Two Way Corner Blow Pattern - Lay In T-Bar
XG-LTC3-6 Single Deflection Supply Grille - Three Way Corner Blow Pattern - Lay In T-Bar
XG-LS3-6 Single Deflection Supply Grille - Three Way Blow Pattern - Lay In T-Bar
XG-LS4-6 Single Deflection Supply Grille - Four Way Blow Pattern - Lay In T-Bar

- Models: **XG-L-6 (One Way - Long Blades - Lay In T-Bar)**
 XG-S-6 (One Way - Long Blades - Lay In T-Bar)

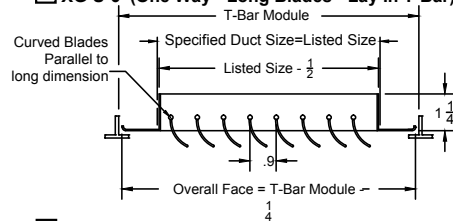

Face View (XG-L-6 Model)

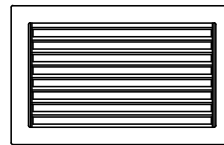

Face View (XG-S-6 Model)

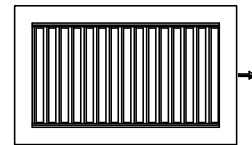

- Models: **XG-LT-6 (Two Way - Long Blades - Lay In T-Bar)**
 XG-ST-6 (Two Way - Short Blades - Lay In T-Bar)

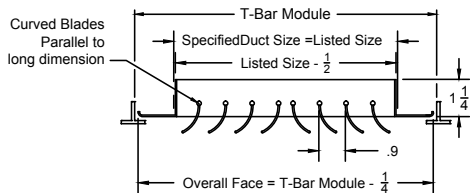

Face View (XG-LT-6 Model)

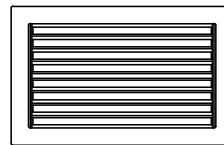

Face View (XG-ST-6 Model)

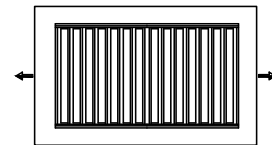

- Models: **XG-LTC-6 (Two Way Corner Blow Pattern - Lay In T-Bar)**
 XG-LTC3-6 (Three Way Corner Blow Pattern - Lay In T-Bar)

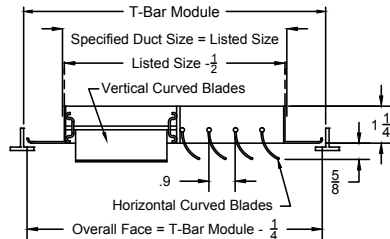

Face View (XG-LTC-6 Model)

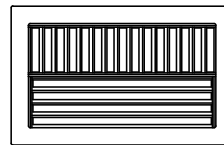

Face View (XG-LTC3-6 Model)

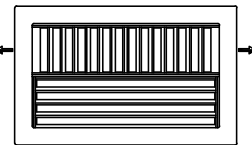

- Models: **XG-LS3-6 (Three Way Blow Pattern - Lay In T-Bar)**
 XG-LS4-6 (Four Way Blow Pattern - Lay In T-Bar)

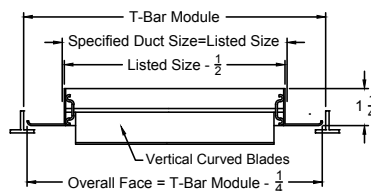

Face View (XG-LS3-6 Model)

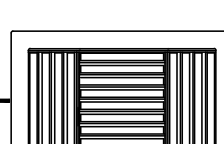

Face View (XG-LS4-6 Model)

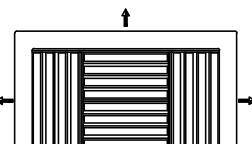

Note: Arrow shows air blow way.

MODEL XG-L

Supply Curved Blade Ceiling Grilles / Registers Aluminum - Single Deflection - Surface Mount

Models: XG-OBD / XG-OBDA

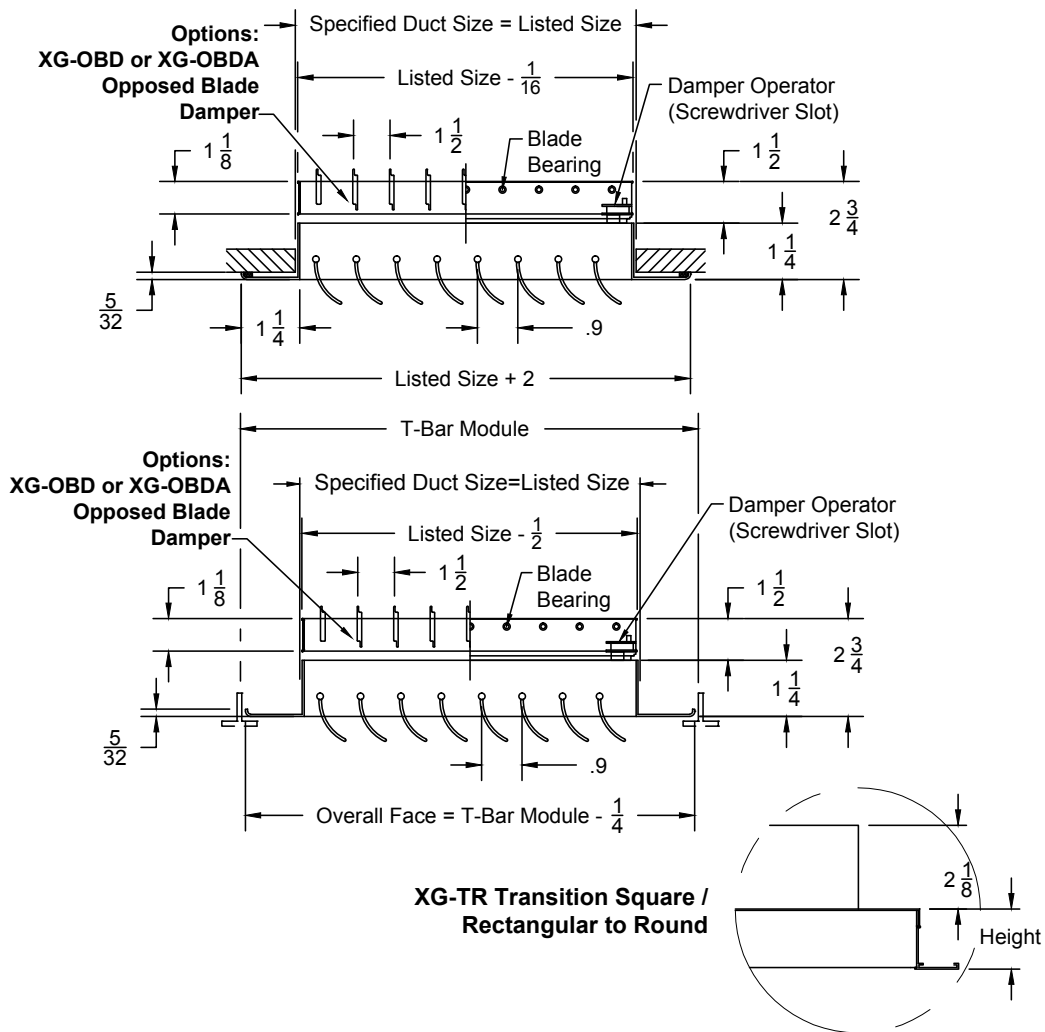

Notes: (check if provided)

1. Available Finishes	2. Available Accessories	3. Available Options	4. Construction Details
Standard Finish: <input type="checkbox"/> 01 White. Optional Finish (no extra charge): <input type="checkbox"/> 24 Mill Finish. Optional Finish (additional Charge): <input type="checkbox"/> 02 Satin silver <input type="checkbox"/> 03 Black <input type="checkbox"/> 28 Custom Color / Setup Charge	<input type="checkbox"/> XG-OBD - Steel Opposed Blade Damper <input type="checkbox"/> XG-OBDA - Aluminum Opposed Blade Damper <input type="checkbox"/> XG-L9 - Equalizing Grid. <input type="checkbox"/> XG-PF - Plaster Frame. <input type="checkbox"/> XG-TBPF T - Bar Plaster Frame <input type="checkbox"/> XG-TR - Transition Square/Rectangular to Round Up to 22 x 22 <input type="checkbox"/> XG-TR - Deep Transition Used with Dampers <input type="checkbox"/> IS - Insect Screen <input type="checkbox"/> XG-LIPF - Lay-In Plaster Frame		<ul style="list-style-type: none"> ● Odd / Fractional Sizes. ● Oversized units made in multiple sections, each with full flanges. ● Mullion strips provided for joining units in field. ● Can be ordered to fit standard T-Bar grid sizes.

XG-L MODEL NUMBER SPECIFICATION**ALUMINUM CEILING CURVED BLADE SUPPLY GRILLE — SURFACE MOUNT**

Model		Neck											
		6	8	10	12	14	16	18	20	22	24	26	
XG-L1	One-Way Long Blades												
XG-S1	One-Way Short Blades	4	X	X	X	X	X	X	X	X	X	X	
XG-LT-1	Two-Way Long Blades	5	X	X	X	X	X	X	X	X	X	X	
XG-ST-1	Two-Way Short Blades	6	X	X	X	X	X	X	X	X	X	X	
		8		X	X	X	X	X	X	X	X	X	
		10			X	X	X	X	X	X	X	X	
		12				X	X	X	X	X	X	X	
		14					X	X	X	X	X	X	
		16						X	X	X	X	X	
		18							X	X	X	X	
		20								X	X	X	
		22									X	X	
		24										X	
		26											

Model		Neck											
		28	30	32	34	36	38	40	42	44	46	48	
XG-L1	One-Way Long Blades												
XG-S1	One-Way Short Blades	4	X	X	X	X	X	X	X	X	X	X	
XG-LT-1	Two-Way Long Blades	5	X	X	X	X	X	X	X	X	X	X	
XG-ST-1	Two-Way Short Blades	6	X	X	X	X	X	X	X	X	X	X	
		8	X	X	X	X	X	X	X	X	X	X	
		10	X	X	X	X	X	X	X	X	X	X	
		12	X	X	X	X	X	X	X	X	X	X	
		14	X	X	X	X	X	X	X	X	X	X	
		16	X	X	X	X	X	X	X	X	X	X	
		18	X	X	X	X	X	X	X	X	X	X	
		20	X	X	X	X	X	X	X	X	X	X	
		22	X	X	X	X	X	X	X	X	X	X	
		24	X	X	X	X	X	X	X	X	X	X	
		26	X	X	X	X	X	X	X	X	X	X	

Available Finishes		Available Accessories	
Standard		XG-OBDA	Steel Opposed Blade Damper
01	White	XG-OBDA	Aluminum Opposed Blade Damper
Optional		XG-L9	Equalizing Grid
02	Satin Silver	XG-PF	Plaster Frame
03	Black	IS	Insect Screen
24	Mill	XG-TR	Square to Round Transition
28	Custom Color	XG-TR Deep	Deep Square to Round Transition

Available Options	
NSH	No Screw Holes
CM	Concealed Mounting

XG-L MODEL NUMBER SPECIFICATION
ALUMINUM CEILING CURVED BLADE SUPPLY GRILLE — SURFACE MOUNT

Model		Neck											
		28	30	32	34	36	38	40	42	44	46	48	
XG-L1	One-Way Long Blades												
XG-S1	One-Way Short Blades	28	X	X	X	X	X	X	X	X	X	X	X
XG-LT-1	Two-Way Long Blades	30		X	X	X	X	X	X	X	X	X	X
XG-ST-1	Two-Way Short Blades	32			X	X	X	X	X	X	X	X	X
		34				X	X	X	X	X	X	X	X
		36					X	X	X	X	X	X	X
		38						X	X	X	X	X	X
		40							X	X	X	X	X
		42								X	X	X	X
		44									X	X	X
		46										X	X
		48										X	

Available Finishes		Available Accessories	
Standard		XG-OBDA	Steel Opposed Blade Damper
01	White	XG-OBDA	Aluminum Opposed Blade Damper
Optional		XG-L9	Equalizing Grid
02	Satin Silver	XG-PF	Plaster Frame
03	Black	IS	Insect Screen
24	Mill	XG-TR	Square to Round Transition
28	Custom Color	XG-TR Deep	Deep Square to Round Transition

Available Options	
NSH	No Screw Holes
CM	Concealed Mounting

XG-L MODEL NUMBER SPECIFICATION**ALUMINUM CEILING CURVED BLADE SUPPLY GRILLE — SURFACE MOUNT**

Model		Neck											
		6	8	10	12	14	16	18	20	22	24	26	
XG-LTC-1	Two-Way Corner Blow Pattern												
XG-LTC-3-1	Three-Way Corner Blow Pattern	4		X	X	X	X	X	X	X	X	X	
XG-LS3-1	Three-Way Blow Pattern	5		X	X	X	X	X	X	X	X	X	
XG-LS4-1	Four-Way Blow Pattern	6	X	X	X	X	X	X	X	X	X	X	
XG-LV-1	One-Way Long Blades with Rear Vertical Blades	8		X	X	X	X	X	X	X	X	X	
XG-SH-1	One-Way Short Blades with Rear Horizontal Blades	10			X	X	X	X	X	X	X	X	
XG-LTV-1	Two-Way Long Blades with Rear Vertical Blades	12				X	X	X	X	X	X	X	
XG-STH-1	Two-Way Short Blades with Rear Horizontal Blades	14					X	X	X	X	X	X	
		16						X	X	X	X	X	
		18							X	X	X	X	
		20								X	X	X	
		22									X	X	
		24										X	
		26											X

Model		Neck										
		28	30	32	34	36	38	40	42	44	46	48
XG-LTC-1	Two-Way Corner Blow Pattern											
XG-LTC-3-1	Three-Way Corner Blow Pattern	6	X	X	X	X	X	X	X	X	X	X
XG-LS3-1	Three-Way Blow Pattern	8	X	X	X	X	X	X	X	X	X	X
XG-LS4-1	Four-Way Blow Pattern	10	X	X	X	X	X	X	X	X	X	X
XG-LV-1	One-Way Long Blades with Rear Vertical Blades	12	X	X	X	X	X	X	X	X	X	X
XG-SH-1	One-Way Short Blades with Rear Horizontal Blades	14	X	X	X	X	X	X	X	X	X	X
XG-LTV-1	Two-Way Long Blades with Rear Vertical Blades	16	X	X	X	X	X	X	X	X	X	X
XG-STH-1	Two-Way Short Blades with Rear Horizontal Blades	18	X	X	X	X	X	X	X	X	X	X
		20	X	X	X	X	X	X	X	X	X	X
		22	X	X	X	X	X	X	X	X	X	X
		24	X	X	X	X	X	X	X	X	X	X
		26	X	X	X	X	X	X	X	X	X	X

Available Finishes		Available Accessories	
Standard		XG-OBD	Steel Opposed Blade Damper
01	White	XG-OBDA	Aluminum Opposed Blade Damper
Optional		XG-L9	Equalizing Grid
02	Satin Silver	XG-PF	Plaster Frame
03	Black	XG-LIPF	Lay-in Plaster Frame
24	Mill	IS	Insect Screen
28	Custom Color	XG-TR	Square to Round Transition
		XG-TR Deep	Deep Square to Round Transition

Available Options	
NSH	No Screw Holes
CM	Concealed Mounting

XG-L MODEL NUMBER SPECIFICATION
ALUMINUM CEILING CURVED BLADE SUPPLY GRILLE — SURFACE MOUNT

Model		Neck											
		28	30	32	34	36	38	40	42	44	46	48	
XG-LTC-1	Two-Way Corner Blow Pattern												
XG-LTC-3-1	Three-Way Corner Blow Pattern	28	X	X	X	X	X	X	X	X	X	X	
XG-LS3-1	Three-Way Blow Pattern	30		X	X	X	X	X	X	X	X	X	
XG-LS4-1	Four-Way Blow Pattern	32			X	X	X	X	X	X	X	X	
XG-LV-1	One-Way Long Blades with Rear Vertical Blades	34				X	X	X	X	X	X	X	
XG-SH-1	One-Way Short Blades with Rear Horizontal Blades	36					X	X	X	X	X	X	
XG-LTV-1	Two-Way Long Blades with Rear Vertical Blades	38						X	X	X	X	X	
XG-STH-1	Two-Way Short Blades with Rear Horizontal Blades	40							X	X	X	X	
		42								X	X	X	
		44									X	X	
		46										X	
		48											X

Available Finishes		Available Accessories	
Standard		XG-OBDA	Aluminum Opposed Blade Damper
01	White	XG-OBDA	Aluminum Opposed Blade Damper
Optional		XG-L9	Equalizing Grid
02	Satin Silver	XG-PF	Plaster Frame
03	Black	XG-LIPF	Lay-in Plaster Frame
24	Mill	IS	Insect Screen
28	Custom Color	XG-TR	Square to Round Transition
		XG-TR Deep	Deep Square to Round Transition

Available Options	
NSH	No Screw Holes
CM	Concealed Mounting

XG-L MODEL NUMBER SPECIFICATION

ALUMINUM CEILING CURVED BLADE SUPPLY GRILLE — LAY-IN

Model		Neck										Module	
		4	6	8	10	12	14	16	18	20	22		24
XG-L-6	One-Way Long Blades												12 x 12
XG-S-6	One-Way Short Blades	4	X	X									
XG-LT-6	Two-Way Long Blades	6	X	X									
XG-ST-6	Two-Way Short Blades	8	X	X									
		10			X								24 x 12
		4	X	X	X	X	X	X	X	X			
		6	X	X	X	X	X	X	X	X			
		8	X	X	X	X	X	X	X	X			
		10									X		24 x 24
		4	X	X	X	X	X	X	X	X			
		6	X	X	X	X	X	X	X	X			
		8	X	X	X	X	X	X	X	X			
		10	X	X	X	X	X	X	X	X			
		12	X	X	X	X	X	X	X	X			
		14	X	X	X	X	X	X	X	X			
		16	X	X	X	X	X	X	X	X			
		18	X	X	X	X	X	X	X	X			
		20	X	X	X	X	X	X	X	X			
		22									X		48 x 24
		4	X	X	X	X	X	X	X	X	X	X	
		6	X	X	X	X	X	X	X	X	X	X	
		8	X	X	X	X	X	X	X	X	X	X	
		10	X	X	X	X	X	X	X	X	X	X	
		12	X	X	X	X	X	X	X	X	X	X	
		14	X	X	X	X	X	X	X	X	X	X	
		16	X	X	X	X	X	X	X	X	X	X	
		18	X	X	X	X	X	X	X	X	X	X	
		20	X	X	X	X	X	X	X	X	X	X	

Available Finishes		Available Accessories	
Standard		XG-OB	Steel Opposed Blade Damper
01	White	XG-OBDA	Aluminum Opposed Blade Damper
Optional		XG-L9	Equalizing Grid
02	Satin Silver	XG-TBPF	T-bar Plaster Frame
03	Black	IS	Insect Screen
24	Mill	XG-TR	Square to Round Transition
28	Custom Color	XG-TR Deep	Deep Square to Round Transition

XG-L MODEL NUMBER SPECIFICATION
ALUMINUM CEILING CURVED BLADE SUPPLY GRILLE – LAY-IN

Model		Neck											Module
		6	8	10	12	14	16	18	20	22	24		
XG-L-6	One-Way Long Blades		X	X	X	X	X	X	X	X	X	X	48 x 48
XG-S-6	One-Way Short Blades	4	X	X	X	X	X	X	X	X	X	X	
XG-LT-6	Two-Way Long Blades	6	X	X	X	X	X	X	X	X	X	X	
XG-ST-6	Two-Way Short Blades	8	X	X	X	X	X	X	X	X	X	X	
		10	X	X	X	X	X	X	X	X	X	X	
		12	X	X	X	X	X	X	X	X	X	X	
		14	X	X	X	X	X	X	X	X	X	X	
		16	X	X	X	X	X	X	X	X	X	X	
		18	X	X	X	X	X	X	X	X	X	X	
		20	X	X	X	X	X	X	X	X	X	X	
		22	X	X	X	X	X	X	X	X	X	X	
		24	X	X	X	X	X	X	X	X	X	X	
		26	X	X	X	X	X	X	X	X	X	X	
		28	X	X	X	X	X	X	X	X	X	X	
		30	X	X	X	X	X	X	X	X	X	X	
		32	X	X	X	X	X	X	X	X	X	X	
		34	X	X	X	X	X	X	X	X	X	X	
		36	X	X	X	X	X	X	X	X	X	X	
		38	X	X	X	X	X	X	X	X	X	X	
		40	X	X	X	X	X	X	X	X	X	X	
		42	X	X	X	X	X	X	X	X	X	X	
		44	X	X	X	X	X	X	X	X	X	X	

Available Finishes		Available Accessories	
Standard		XG-OB	Steel Opposed Blade Damper
01	White	XG-OBDA	Aluminum Opposed Blade Damper
Optional		XG-L9	Equalizing Grid
02	Satin Silver	XG-TBPF	T-bar Plaster Frame
03	Black	IS	Insect Screen
24	Mill	XG-TR	Square to Round Transition
28	Custom Color	XG-TR Deep	Deep Square to Round Transition

XG-L MODEL NUMBER SPECIFICATION
ALUMINUM CEILING CURVED BLADE SUPPLY GRILLE – LAY-IN

Model		Neck												Module
		26	28	30	32	34	36	38	40	42	44	46		
XG-L-6	One-Way Long Blades													
XG-S-6	One-Way Short Blades	4	X	X	X	X	X	X	X	X	X	X		48 x 24
XG-LT-6	Two-Way Long Blades	6	X	X	X	X	X	X	X	X	X	X		
XG-ST-6	Two-Way Short Blades	8	X	X	X	X	X	X	X	X	X	X		
		10	X	X	X	X	X	X	X	X	X	X		
		12	X	X	X	X	X	X	X	X	X	X		
		14	X	X	X	X	X	X	X	X	X	X		
		16	X	X	X	X	X	X	X	X	X	X		
		18	X	X	X	X	X	X	X	X	X	X		
		20	X	X	X	X	X	X	X	X	X	X		
		22											X	
		4	X	X	X	X	X	X	X	X	X	X		48 x 48
		6	X	X	X	X	X	X	X	X	X	X		
		8	X	X	X	X	X	X	X	X	X	X		
		10	X	X	X	X	X	X	X	X	X	X		
		12	X	X	X	X	X	X	X	X	X	X		
		14	X	X	X	X	X	X	X	X	X	X		
		16	X	X	X	X	X	X	X	X	X	X		
		18	X	X	X	X	X	X	X	X	X	X		
		20	X	X	X	X	X	X	X	X	X	X		
		22	X	X	X	X	X	X	X	X	X	X		
		24	X	X	X	X	X	X	X	X	X	X		
		26	X	X	X	X	X	X	X	X	X	X		
		28	X	X	X	X	X	X	X	X	X	X		
		30	X	X	X	X	X	X	X	X	X	X		
		32	X	X	X	X	X	X	X	X	X	X		
		34	X	X	X	X	X	X	X	X	X	X		
		36	X	X	X	X	X	X	X	X	X	X		
		38	X	X	X	X	X	X	X	X	X	X		
		40	X	X	X	X	X	X	X	X	X	X		
		42	X	X	X	X	X	X	X	X	X	X		
		44	X	X	X	X	X	X	X	X	X	X		
		46											X	

Available Finishes		Available Accessories	
Standard		XG-OB	Steel Opposed Blade Damper
01	White	XG-OBDA	Aluminum Opposed Blade Damper
Optional		XG-L9	Equalizing Grid
02	Satin Silver	XG-TBPF	T-bar Plaster Frame
03	Black	IS	Insect Screen
24	Mill	XG-TR	Square to Round Transition
28	Custom Color	XG-TR Deep	Deep Square to Round Transition

XG-L MODEL NUMBER SPECIFICATION
ALUMINUM CEILING CURVED BLADE SUPPLY GRILLE – LAY-IN

Model												Module
		6	8	10	12	14	16	18	20	22	24	
XG-LTC-6	Two-Way Corner Blow Pattern											12 x 12
XG-LTC3-6	Three-Way Corner Blow Pattern	4	X									12 x 12
XG-LS3-6	Three-Way Blow Pattern	6	X	X								
XG-LS4-6	Four-Way Blow Pattern	8	X	X								
XG-LV-6	One-Way Long Blades with Rear Vertical Blades	10			X							
XG-SH-6	One-Way Short Blades with Rear Horizontal Blades	4		X	X	X	X	X	X			24 x 12
XG-LTV-6	Two-Way Long Blades with Rear Vertical Blades	6	X	X	X	X	X	X	X			
XG-STH-6	Two-Way Short Blades with Rear Horizontal Blades	8	X	X	X	X	X	X	X			
		10								X		24 x 24
		4		X	X	X	X	X	X			
		6	X	X	X	X	X	X	X			
		8	X	X	X	X	X	X	X			
		10	X	X	X	X	X	X	X			
		12	X	X	X	X	X	X	X			
		14	X	X	X	X	X	X	X			
		16	X	X	X	X	X	X	X			
		18	X	X	X	X	X	X	X			
		20	X	X	X	X	X	X	X			
		22								X		
		4		X	X	X	X	X	X	X	X	48 x 24
		6	X	X	X	X	X	X	X	X	X	
		8	X	X	X	X	X	X	X	X	X	
		10	X	X	X	X	X	X	X	X	X	
		12	X	X	X	X	X	X	X	X	X	
		14	X	X	X	X	X	X	X	X	X	
		16	X	X	X	X	X	X	X	X	X	
		18	X	X	X	X	X	X	X	X	X	
		20	X	X	X	X	X	X	X	X	X	

Available Finishes		Available Accessories	
Standard		XG-OB	Steel Opposed Blade Damper
01	White	XG-OBDA	Aluminum Opposed Blade Damper
Optional		XG-L9	Equalizing Grid
02	Satin Silver	XG-TBPF	T-bar Plaster Frame
03	Black	IS	Insect Screen
24	Mill	XG-TR	Square to Round Transition
28	Custom Color	XG-TR Deep	Deep Square to Round Transition

XG-L MODEL NUMBER SPECIFICATION

ALUMINUM CEILING CURVED BLADE SUPPLY GRILLE — LAY-IN

Model		Neck										Module	
		6	8	10	12	14	16	18	20	22	24		
XG-LTC-6	Two-Way Corner Blow Pattern												48 x 48
XG-LTC3-6	Three-Way Corner Blow Pattern	4	X	X	X	X	X	X	X	X	X		
XG-LS3-6	Three-Way Blow Pattern	6	X	X	X	X	X	X	X	X	X		
XG-LS4-6	Four-Way Blow Pattern	8	X	X	X	X	X	X	X	X	X		
XG-LV-6	One-Way Long Blades with Rear Vertical Blades	10	X	X	X	X	X	X	X	X	X		
XG-SH-6	One-Way Short Blades with Rear Horizontal Blades	12	X	X	X	X	X	X	X	X	X		
XG-LTV-6	Two-Way Long Blades with Rear Vertical Blades	14	X	X	X	X	X	X	X	X	X		
XG-STH-6	Two-Way Short Blades with Rear Horizontal Blades	16	X	X	X	X	X	X	X	X	X		
		18	X	X	X	X	X	X	X	X	X		
		20	X	X	X	X	X	X	X	X	X		
		22	X	X	X	X	X	X	X	X	X		
		24	X	X	X	X	X	X	X	X	X		
		26	X	X	X	X	X	X	X	X	X		
		28	X	X	X	X	X	X	X	X	X		
		30	X	X	X	X	X	X	X	X	X		
		32	X	X	X	X	X	X	X	X	X		
		34	X	X	X	X	X	X	X	X	X		
		36	X	X	X	X	X	X	X	X	X		
		38	X	X	X	X	X	X	X	X	X		
		40	X	X	X	X	X	X	X	X	X		
		42	X	X	X	X	X	X	X	X	X		
		44	X	X	X	X	X	X	X	X	X		

Available Finishes		Available Accessories	
Standard		XG-OB	Steel Opposed Blade Damper
01	White	XG-OBDA	Aluminum Opposed Blade Damper
Optional		XG-L9	Equalizing Grid
02	Satin Silver	XG-TBPF	T-bar Plaster Frame
03	Black	IS	Insect Screen
24	Mill	XG-TR	Square to Round Transition
28	Custom Color	XG-TR Deep	Deep Square to Round Transition

XG-L MODEL NUMBER SPECIFICATION
ALUMINUM CEILING CURVED BLADE SUPPLY GRILLE – LAY-IN

Model		Neck											Module	
		26	28	30	32	34	36	38	40	42	44	46		
XG-LTC-6	Two-Way Corner Blow Pattern												48 x 24	
XG-LTC3-6	Three-Way Corner Blow Pattern	4	X	X	X	X	X	X	X	X	X	X		
XG-LS3-6	Three-Way Blow Pattern	6	X	X	X	X	X	X	X	X	X	X		
XG-LS4-6	Four-Way Blow Pattern	8	X	X	X	X	X	X	X	X	X	X		
XG-LV-6	One-Way Long Blades with Rear Vertical Blades	10	X	X	X	X	X	X	X	X	X	X		
XG-SH-6	One-Way Short Blades with Rear Horizontal Blades	12	X	X	X	X	X	X	X	X	X	X		
XG-LTV-6	Two-Way Long Blades with Rear Vertical Blades	14	X	X	X	X	X	X	X	X	X	X		
XG-STH-6	Two-Way Short Blades with Rear Horizontal Blades	16	X	X	X	X	X	X	X	X	X	X		
		18	X	X	X	X	X	X	X	X	X	X	48 x 48	
		20	X	X	X	X	X	X	X	X	X	X		
		22												X
		4	X	X	X	X	X	X	X	X	X	X		
		6	X	X	X	X	X	X	X	X	X	X		
		8	X	X	X	X	X	X	X	X	X	X		
		10	X	X	X	X	X	X	X	X	X	X		
		12	X	X	X	X	X	X	X	X	X	X		
		14	X	X	X	X	X	X	X	X	X	X		
		16	X	X	X	X	X	X	X	X	X	X		
		18	X	X	X	X	X	X	X	X	X	X		
		20	X	X	X	X	X	X	X	X	X	X		
		22	X	X	X	X	X	X	X	X	X	X		
		24	X	X	X	X	X	X	X	X	X	X		
		26	X	X	X	X	X	X	X	X	X	X		
		28	X	X	X	X	X	X	X	X	X	X		
		30	X	X	X	X	X	X	X	X	X	X		
		32	X	X	X	X	X	X	X	X	X	X		
		34	X	X	X	X	X	X	X	X	X	X		
		36	X	X	X	X	X	X	X	X	X	X		
		38	X	X	X	X	X	X	X	X	X	X		
		40	X	X	X	X	X	X	X	X	X	X		
		42	X	X	X	X	X	X	X	X	X	X		
		44	X	X	X	X	X	X	X	X	X	X		
		46											X	

Available Finishes		Available Accessories	
Standard		XG-OBD	Steel Opposed Blade Damper
01	White	XG-OBDA	Aluminum Opposed Blade Damper
Optional		XG-L9	Equalizing Grid
02	Satin Silver	XG-TBPF	T-bar Plaster Frame
03	Black	IS	Insect Screen
24	Mill	XG-TR	Square to Round Transition
28	Custom Color	XG-TR Deep	Deep Square to Round Transition

XG-L MODEL NUMBER SPECIFICATION

ALUMINUM CEILING CURVED BLADE SUPPLY WITH MULTI-SHUTTER DAMPER

Model		Neck											Available Finishes	
XG-LM-1	One-Way Long Blades		6	8	10	12	14	16	18	20	22	24	Standard	
XG-SM-1	One-Way Short Blades	4	X	X	X	X	X	X	X	X	X	X	01	White
XG-LTM-1	Two-Way Long Blades	5	X	X	X	X	X	X	X	X	X	X	Optional	
XG-STM-1	Two-Way Short Blades	6	X	X	X	X	X	X	X	X	X	X	02	Satin Silver
		8		X	X	X	X	X	X	X	X	X	03	Black
		10			X	X	X	X	X	X	X	X	24	Mill
		12				X	X	X	X	X	X	X	28	Custom Color
		14					X	X	X	X	X	X		
		16						X	X	X	X	X		
		18							X	X	X	X		
		20								X	X	X		
		22									X	X		
		24										X		

XG-L MODEL NUMBER SPECIFICATION

ALUMINUM CEILING CURVED BLADE SUPPLY WITH HORIZONTAL MULTI-SHUTTER DAMPER

Model		Neck					Available Finishes		
XG-LMH-1	One-Way Long Blades		6	8	10	12	14	Standard	
XG-LTMH-1	Two-Way Long Blades	4	X	X	X	X	X	01	White
		6	X	X	X	X	X	Optional	
		8		X	X	X	X	02	Satin Silver
		10			X			03	Black
		12				X		24	Mill
								28	Custom Color

XG-L MODEL NUMBER SPECIFICATION

ALUMINUM CEILING CURVED BLADE SUPPLY WITH HORIZONTAL MULTI-SHUTTER DAMPER

Model		Neck					Available Finishes		
XG-LTCM-1	One-Way Corner Blow		6	8	10	12	14	Standard	
XG-LTC3M-1	Three-Way Corner Blow	6	X					01	White
XG-LS3M-1	Three-Way Blow	8		X				Optional	
XG-LS4M-1	Four-Way Blow	10			X			02	Satin Silver
		12				X		03	Black
		14					X	24	Mill
								28	Custom Color

SERIES XG-L PERFORMANCE DATA
MODELS XG-L, XG-S, XG-LT, XG-ST, XG-LTC, XG-LTC3, XG-LS4, XG-LV, XG-SH, XG-LTV, XG-STH, XG-LM, XG-SM, XG-LTM, XG-STM, XG-LTCM, XG-LTC3M, XG-LMH, XG-LTMH, XG-LS3M, XG-LS4M

Size		Nk Vel	100	150	200	250	300	350	400
06x04	Ac ft ² 0.17	CFM	17	25	34	42	50	58	67
		Ps	.006	.013	.024	.037	.053	.072	.093
		NC	-	-	-	13	18	22	26
	Throw		4-4-3-3	7-6-5-5	9-8-7-6	11-10-8-8	13-12-10-9	15-14-12-11	18-15-13-12
06x06	Ac ft ² 0.25	CFM	25	38	50	63	75	88	100
		Ps	.005	.011	.020	.031	.045	.062	.081
		NC	-	-	-	13	18	22	25
	Throw		6-6-5-4	10-8-7-7	13-11-10-9	16-14-12-11	19-17-14-13	22-19-17-16	25-22-19-18
08x08 10x06 12x05	Ac ft ² 0.42	CFM	45	67	89	112	134	156	178
		Ps	.004	.010	.018	.028	.040	.054	.070
		NC	-	-	-	13	18	22	25
	Throw		7-6-5-5	11-10-8-8	14-13-11-10	18-16-14-13	22-19-16-15	25-22-19-18	29-25-22-20
12x06	Ac ft ² 0.50	CFM	50	75	100	125	150	175	200
		Ps	.004	.010	.018	.027	.039	.054	.070
		NC	-	-	-	13	18	22	26
	Throw		7-6-5-5	10-9-7-7	13-12-10-9	16-14-12-12	20-17-15-16	23-20-17-16	26-23-20-18
10x08 14x06	Ac ft ² 0.56	CFM	56	84	111	139	167	194	222
		Ps	.004	.010	.017	.028	.038	.051	.067
		NC	-	-	-	13	18	22	25
	Throw		7-6-5-5	10-9-8-7	14-12-10-10	17-15-13-12	20-18-15-14	24-21-18-17	27-24-20-19
10x10 12x08 16x06	Ac ft ² 0.69	CFM	70	104	139	174	209	243	278
		Ps	.004	.009	.016	.025	.036	.049	.065
		NC	-	-	-	13	18	22	26
	Throw		8-7-6-6	12-11-9-8	16-14-12-11	20-18-15-14	24-21-18-17	28-25-21-20	32-28-24-22
14x08 18x06	Ac ft ² 0.77	CFM	78	117	156	195	233	272	311
		Ps	.004	.009	.016	.025	.036	.049	.064
		NC	-	-	-	14	18	22	26
	Throw		8-7-6-5	12-10-9-8	16-14-12-11	20-17-15-14	23-20-18-16	27-24-20-19	31-27-23-22
12x10 20x06	Ac ft ² 0.83	CFM	83	125	166	208	250	291	333
		Ps	.004	.009	.016	.024	.035	.048	.063
		NC	-	-	-	14	18	22	26
	Throw		8-7-6-6	12-10-9-8	16-14-12-11	20-17-15-14	24-21-18-17	28-24-21-20	32-28-24-22

SERIES XG-L PERFORMANCE DATA

MODELS XG-L, XG-S, XG-LT, XG-ST, XG-LTC, XG-LTC3, XG-LS4, XG-LV, XG-SH, XG-LTV, XG-STH, XG-LM, XG-SM, XG-LTM, XG-STM, XG-LTCM, XG-LTC3M, XG-LMH, XG-LTMH, XG-LS3M, XG-LS4M

Size		Nk Vel	100	150	200	250	300	350	400
16x08 22x06	Ac ft ² 0.89	CFM	89	134	178	223	267	312	356
		Ps	.004	.009	.016	.025	.036	.049	.063
		NC	-	-	-	14	19	23	26
		Throw	9-7-6-6	12-11-9-8	17-14-12-11	21-18-15-14	25-22-19-17	29-25-22-20	33-29-25-23
14x10 28x05	Ac ft ² 0.97	CFM	97	146	194	243	292	340	389
		Ps	.004	.009	.015	.024	.035	.047	.062
		NC	-	-	-	14	19	23	26
		Throw	8-7-6-5	13-11-10-9	17-15-13-12	21-19-16-15	26-22-19-18	30-26-22-21	34-30-26-24
12x12 24x06 18x08	Ac ft ² 1.00	CFM	100	150	200	250	300	350	400
		Ps	9-8-7-6	13-11-10-9	18-15-13-12	22-19-16-15	26-23-20-18	31-27-23-21	35-31-26-25
		NC	-	-	-	14	19	23	26
		Throw	9-8-7-6	13-11-10-9	18-15-13-12	22-19-16-15	26-23-20-18	31-27-13-21	35-31-26-25
30x06 18x10	Ac ft ² 1.25	CFM	125	188	250	313	375	438	500
		Ps	.004	.008	.015	.023	.034	.046	.060
		NC	-	-	-	14	19	23	27
		Throw	9-8-7-6	14-12-11-10	19-17-14-13	24-21-18-17	28-25-21-20	33-29-25-23	38-33-28-26
14x14	Ac ft ² 1.36	CFM	136	204	272	241	409	477	545
		Ps	.004	.008	.015	.023	.033	.045	.059
		NC	-	-	-	15	19	23	27
		Throw	9-8-7-6	14-12-11-10	19-17-14-13	24-21-18-17	28-25-21-20	33-29-25-23	38-33-28-27
36x06 18x12	Ac ft ² 1.50	CFM	150	225	300	375	450	525	600
		Ps	.004	.008	.015	.023	.033	.045	.059
		NC	-	-	-	15	19	23	27
		Throw	10-9-8-7	15-13-11-10	20-18-15-14	25-22-19-18	30-27-23-21	36-31-27-25	41-36-30-28

PERFORMANCE NOTES FOR SERIES XG-L

All data is tested in accordance with ANSI/ASHRAE 70-2006.

DEFINITION OF UNITS

CFM Cubic Feet per Minute (air)

fpm Velocity of air stream in Feet per Minute

Ps Static pressure = Pt-Pv (inches of water column)

Throw Throw distance in feet are for terminal velocities of 50 fpm for 1W, 2W, 3W & 4W air flow

Nk Vel Neck Velocity is the airstream velocity in the duct just before it reaches the supply outlet; measured in feet per minute

NC Noise Criteria based on a room absorption of 10 dB, re: 10⁻¹² watts [NC less than 10 (-)]

Ac Actual Core Free Area in square feet

SERIES XG-L PERFORMANCE DATA
MODELS XG-L, XG-S, XG-LT, XG-ST, XG-LTC, XG-LTC3, XG-LS4, XG-LV, XG-SH, XG-LTV, XG-STH, XG-LM, XG-SM, XG-LTM, XG-STM, XG-LTCM, XG-LTC3M, XG-LMH, XG-LTMH, XG-LS3M, XG-LS4M

Size		Nk Vel	100	150	200	250	300	350	400
22x10	Ac ft ² 1.53	CFM	153	230	306	383	459	536	612
		Ps	.004	.008	.015	.023	.033	.045	.059
		NC	-	-	-	15	20	24	27
	Throw		10-9-8-7	15-13-12-11	21-18-15-14	26-22-19-18	31-27-23-22	36-31-27-25	41-36-31-29
30x08 24x10	Ac ft ² 1.67	CFM	166	249	333	416	499	583	666
		Ps	.004	.008	.015	.024	.034	.046	.060
		NC	-	-	-	15	20	24	28
	Throw		11-9-8-7	16-14-12-11	21-19-16-15	27-23-20-19	32-28-24-23	38-33-28-26	43-38-32-30
16x16	Ac ft ² 1.78	CFM	178	267	356	445	533	622	711
		Ps	.004	.008	.014	.022	.032	.044	.057
		NC	-	-	-	15	20	24	27
	Throw		10-9-8-7	15-13-11-10	20-18-15-14	25-22-19-18	31-27-23-21	36-31-27-25	41-36-30-28
24x12 36x08 48x06	Ac ft ² 2.00	CFM	200	300	400	500	600	700	800
		Ps	.004	.008	.014	.022	.032	.044	.057
		NC	-	-	-	15	20	24	27
	Throw		11-10-9-8	17-15-13-12	23-20-17-16	29-25-21-20	34-30-26-24	40-35-30-28	46-40-34-32
18x18	Ac ft ² 2.25	CFM	224	337	449	562	675	787	900
		Ps	.003	.008	.014	.022	.031	.043	.056
		NC	-	-	-	15	20	24	28
	Throw		11-9-8-7	16-14-12-11	22-19-16-15	27-24-20-19	32-28-24-23	38-33-28-27	43-38-32-30
30x12 36x10	Ac ft ² 2.50	CFM	250	375	500	625	750	875	1000
		Ps	.004	.008	.014	.022	.032	.043	.057
		NC	-	-	-	16	21	25	28
	Throw		13-11-9-9	19-17-14-13	25-22-19-18	31-28-24-22	38-33-28-26	44-39-33-31	50-44-38-35
20x20	Ac ft ² 2.78	CFM	278	417	555	694	833	971	1110
		Ps	.003	.008	.014	.021	.031	.042	.055
		NC	-	-	-	16	21	25	28
	Throw		11-10-9-8	17-15-13-12	23-20-17-16	29-25-21-20	34-30-26-24	40-35-30-28	46-40-34-32
24x18 36x12	Ac ft ² 3.00	CFM	300	450	600	750	900	1050	1200
		Ps	.003	.008	.014	.021	.031	.042	.055
		NC	-	-	-	16	21	25	28
	Throw		14-12-10-9	20-16-15-14	27-24-20-19	34-30-25-24	41-35-30-28	47-41-35-33	54-47-41-38

SERIES XG-L PERFORMANCE DATA

MODELS XG-L, XG-S, XG-LT, XG-ST, XG-LTC, XG-LTC3, XG-LS4, XG-LV, XG-SH, XG-LTV, XG-STH, XG-LM, XG-SM, XG-LTM, XG-STM, XG-LTCM, XG-LTC3M, XG-LMH, XG-LTMH, XG-LS3M, XG-LS4M

Size		Nk Vel	100	150	200	250	300	350	400
22x22 24x20 48x10	Ac ft ² 3.36	CFM	336	504	672	841	1009	1177	1345
		Ps	.003	.008	.014	.021	.031	.042	.054
		NC	-	-	11	16	21	25	28
	Throw		12-11-9-8	18-16-14-13	24-21-18-17	30-26-23-21	36-32-27-25	42-37-32-30	48-42-36-34
24x24 36x16 48x12	Ac ft ² 4.00	CFM	400	600	800	1000	1200	1400	1600
		Ps	.003	.008	.003	.021	.030	.041	.054
		NC	-	-	11	17	21	25	29
	Throw		13-11-10-9	19-17-14-13	25-22-19-18	32-28-24-22	38-33-29-27	44-39-33-31	51-44-38-35
30x24 36x20	Ac ft ² 5.00	CFM	500	750	1000	1250	1500	1750	2000
		Ps	.003	.007	.013	.021	.030	.041	.053
		NC	-	-	12	17	23	26	29
	Throw		17-15-13-12	25-22-19-18	34-29-25-23	42-37-31-29	50-44-38-35	59-51-44-41	67-59-50-47
28x28	Ac ft ² 5.44	CFM	546	818	1091	1363	1635	1908	2180
		Ps	.003	.007	.013	.021	.030	.040	.053
		NC	-	-	12	18	22	26	30
	Throw		14-12-10-10	21-18-16-15	28-24-21-19	35-30-26-24	41-36-31-29	48-42-36-34	55-48-41-39
36x30	Ac ft ² 7.50	CFM	752	1127	1501	1876	2251	2625	3000
		Ps	.003	.007	.013	.020	.029	.040	.052
		NC	-	-	13	18	25	27	30
	Throw		19-17-14-13	30-26-22-21	40-35-30-28	50-44-37-35	60-52-45-42	70-61-52-49	80-70-60-56
36x32 48x24 34x34	Ac ft ² 8.00	CFM	800	1200	1600	2000	2400	2800	3200
		Ps	.003	.007	.013	.020	.029	.040	.052
		NC	-	-	13	19	23	27	31
	Throw		19-17-14-13	31-17-23-22	41-36-31-29	51-45-38-36	62-54-46-43	72-63-54-50	82-72-62-57

PERFORMANCE NOTES FOR SERIES XG-L

All data is tested in accordance with ANSI/ASHRAE 70-2006.

DEFINITION OF UNITS

CFM Cubic Feet per Minute (air)

fpm Velocity of air stream in Feet per Minute

Ps Static pressure = $P_t - P_v$ (inches of water column)

Throw Throw distance in feet are for terminal velocities of 50 fpm for 1W, 2W, 3W & 4W air flow

Nk Vel Neck Velocity is the airstream velocity in the duct just before it reaches the supply outlet; measured in feet per minute

NC Noise Criteria based on a room absorption of 10 dB, re: 10^{-12} watts [NC less than 10 (-)]

Ac Actual Core Free Area in square feet

SERIES XG-L PERFORMANCE DATA
MODELS XG-L, XG-S, XG-LT, XG-ST, XG-LTC, XG-LTC3, XG-LS4, XG-LV, XG-SH, XG-LTV, XG-STH, XG-LM, XG-SM, XG-LTM, XG-STM, XG-LTCM, XG-LTC3M, XG-LMH, XG-LTMH, XG-LS3M, XG-LS4M

Size		Nk Vel	100	200	300	400	500	600	700
36x36	Ac ft ² 9.00	CFM	900	1350	1800	2250	2700	3150	3600
		Ps	.003	.007	.013	.020	.029	.039	.051
		NC	-	-	13	19	23	27	31
	Throw		14-12-11-10	24-21-18-17	32-28-24-22	40-35-30-28	48-42-36-33	56-49-42-39	64-56-48-45
38x38	Ac ft ² 10.02	CFM	1000	1502	2003	2505	3007	3508	4010
		Ps	.003	.007	.013	.020	.029	.039	.051
		NC	-	-	13	19	24	28	31
	Throw		14-12-10-10	25-22-18-17	33-29-25-23	41-36-31-29	49-43-37-34	57-50-43-40	66-57-49-46
40x40	Ac ft ² 11.11	CFM	1110	1665	2220	2775	3330	3885	4440
		Ps	.003	.007	.013	.020	.029	.039	.051
		NC	-	-	14	19	24	28	31
	Throw		14-12-10-10	25-22-19-18	34-30-25-24	42-37-32-30	51-44-38-35	59-52-44-41	68-59-51-47
48x36	Ac ft ² 12.00	CFM	1200	1800	2400	3000	3600	4200	4800
		Ps	.003	.007	.013	.020	.029	.039	.051
		NC	-	-	14	20	24	28	32
	Throw		19-17-14-13	37-32-27-26	49-43-37-34	61-53-46-43	73-64-55-51	85-75-64-60	97-85-73-68
48x42	Ac ft ² 14.00	CFM	1400	2100	2800	3500	4200	4800	5600
		Ps	.003	.007	.013	.020	.029	.039	.051
		NC	-	-	14	20	25	29	32
	Throw		19-17-14-13	39-34-29-27	52-46-39-36	65-57-49-46	78-68-59-55	91-80-68-64	104-91-78-73
48x48	Ac ft ² 16.00	CFM	1600	2400	3200	4000	4800	5600	6400
		Ps	.003	.007	.013	.020	.028	.039	.050
		NC	-	-	15	20	25	29	32
	Throw		13-11-10-9	28-25-21-20	38-33-28-26	47-41-35-33	56-49-42-39	66-58-48-46	75-66-56-53

PERFORMANCE NOTES FOR SERIES XG-L
All data is tested in accordance with ANSI/ASHRAE 70-2006.
DEFINITION OF UNITS
CFM Cubic Feet per Minute (air)
fpm Velocity of air stream in Feet per Minute
Ps Static pressure = Pt-Pv (inches of water column)
Throw distance in feet are for terminal velocities of 50 fpm for 1W, 2W, 3W & 4W air flow
Nk Vel Neck Velocity is the airstream velocity in the duct just before it reaches the supply outlet; measured in feet per minute
NC Noise Criteria based on a room absorption of 10 dB, re: 10⁻¹² watts [NC les than 10 (-)]
Ac Actual Core Free Area in square feet

MODEL XG-RH



Fixed Horizontal Blade Aluminum Return Grille

XG-RH-1 – Surface Mount

XG-RH-6 – T-bar Lay-in

XG-RH-7 – Concealed Spline

XG-RH-8 – Tegular T-bar

XG-RH-9 – Donn Fineline Lay-in

Air Inlets shall be model XG-RH manufactured by GREENHECK. Units shall be return or exhaust grilles of aluminum construction and with an extruded aluminum border and a single set of fixed deflection blades. The units shall be the size and quantity as outlined in the plans and specifications. Border shall be 1 1/4" wide with aerodynamically shaped deflector blades on .666" centers set at 40°. Units shall be designed to integrate into the specified ceiling system.

Hinged/Removable Face (Optional)

Units with XG-RC-1, XG-RC-6, XG-H-1 or XG-H-6 frames shall include a hinged/removable face allowing access to concealed equipment. The units shall be the size and quantity as outlined in the plans and specifications.

XG-RH-H-1 – Surface Mounted with hinged face

XG-RH-H-6 – Lay-In with hinged face

XG-RH-RC-1 – Surface Mounted with removable core

XG-RH-RC-6 – Lay-In with removable core

Air Inlets shall be model XG-RH-H / XG-RH-RC manufactured by GREENHECK. Units shall be return or exhaust grilles constructed of aluminum. The units shall be the size and quantity as outlined in the plans and specifications.

Border shall be 1 1/4" wide with aerodynamically shaped fixed deflector blades on .666" centers set at 45°. Units shall be designed for surface mounting applications and be provided with screw holes on the face of the device.

Series XG-RHE - Specifications – Extruded Aluminum

Fixed Horizontal Blade Extruded Aluminum Return Grille

XG-RHE-1 – Surface Mounted

XG-RHE-6 – T-Bar Lay-In

XG-RHE-9 – Donn Fineline Lay-In

Air Inlets shall be model XG-RHE manufactured by GREENHECK. Units shall be return or exhaust grilles constructed of heavy extruded aluminum. The units shall be the size and quantity as outlined in the plans and specifications. Border shall be 1 1/4" wide with aerodynamically shaped deflector blades on .666" centers set at 40°.

Hinged Face (Optional)

Units (model XG-RHE-H-1) shall include a hinged face allowing access to concealed equipment. The units shall be the size and quantity as outlined in the plans and specifications.

XG-RHE-H-1 – Surface Mounted with hinged face

Air Inlets shall be model XG-RHE-H-1 manufactured by GREENHECK. Units shall be return or exhaust grilles constructed of heavy extruded aluminum. The units shall be the size and quantity as outlined in the plans and specifications.

Border shall be 1 1/4" wide with aerodynamically shaped fixed deflector blades on .666" centers set at 45°. Units shall be designed for surface mounting applications and be provided with screw holes on the face of the device.

Series XG-SRH - Specifications – Steel Fixed Horizontal Blade Steel Return Grille

XG-SRH-1 – Surface Mounted

XG-SRH-6 – T-Bar Lay-In

XG-SRH-9 – Donn Fineline Lay-In

Air Inlets shall be model XG-SRH manufactured by GREENHECK. Units shall be return or exhaust grilles constructed of heavy extruded aluminum. The units shall be the size and quantity as outlined in the plans and specifications. Border shall be 1 1/4" wide with aerodynamically shaped deflector blades on .666" centers set at 40°.

Hinged Face (Optional)

Units (model XG-SRH-H-1) shall include a hinged face allowing access to concealed equipment. The units shall be the size and quantity as outlined in the plans and specifications.

XG-SRH-H-1 – Surface Mounted with hinged face

Air Inlets shall be model XG-SRH-H-1 manufactured by GREENHECK. Units shall be return or exhaust grilles constructed of heavy extruded aluminum. The units shall be the size and quantity as outlined in the plans and specifications.

Border shall be 1 1/4" wide with aerodynamically shaped fixed deflector blades on .666" centers set at 45°. Units shall be designed for surface mounting applications and be provided with screw holes on the face of the device.

For Surface mounting:

Units shall be designed for surface mounting applications and be provided with counter sunk screw holes on the face of the device.

For T-Bar Lay-in:

Units shall be designed to integrate into the specified ceiling system.

Damper Accessories (Optional):

Optional opposed blade damper shall be constructed of steel (model XG-OBD) or aluminum (model XG-OBDA). Damper must be operable from the face of the diffuser.

Performance Specification:

The manufacturer shall provide published performance data. Data shall be tested in accordance to ANSI/ASHRAE Standard 70- 2006

Paint Specification:

Process shall be anodic electrodeposition using an anodic acrylic paint. Units shall undergo pre-treatment including a pressurized spray stage using an alkaline cleaner and a de-ionized water rinse.

MODEL XG-RH

Return Grilles and Registers Roll Formed - 45° Louvered Face

- Models: **XG-RH-1** Return Grille - Surface Mount
 XG-RH-6 Return Grille - Lay-in T-Bar
 XG-RH-7 Return Grille - Concealed Lay-in T-Bar
 XG-RH-8 Return Grille - Tegular Ceiling Lay-in
 XG-RH-9 Return Grille - Bolt Slot Ceiling Grid

Model: XG-RH-1 - Return Grille - Surface Mount

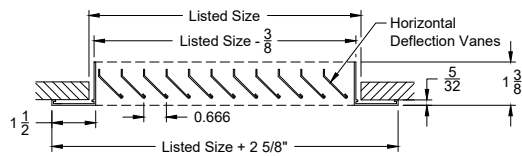

Face View - XG-RH-1 Model

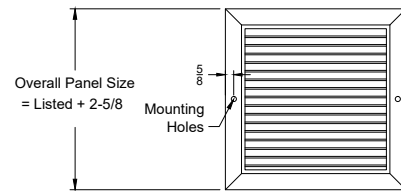

Model: XG-RH-6 - Return Grille - Lay in T-Bar

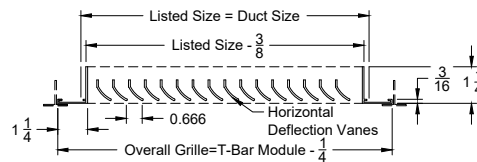

Face View - XG-RH-6 Model

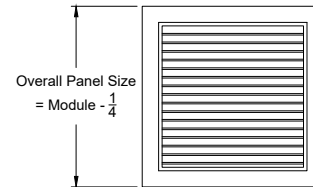

Model: XG-RH-7 - Return Grille - Concealed T-Bar Lay in

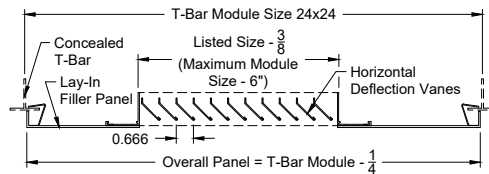

Face View - XG-RH-7 Model

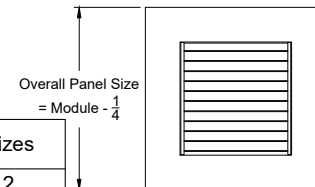

Panel Sizes

12 x 12
24 x 12
24 x 24

Model: XG-RH-8 - Return Grille - Tegular Ceiling Lay in

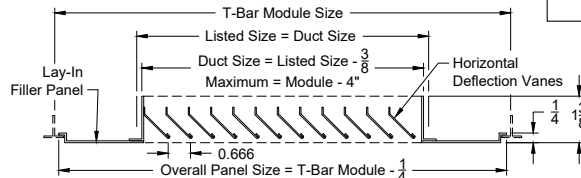

Face View
XG-RH-8 and RH-9

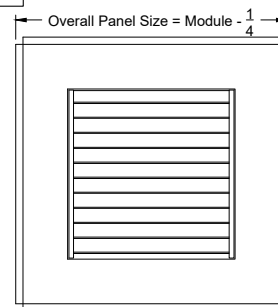

Model: XG-RH-9 - Aluminum Return Grille - Bolt Slot Ceiling Grid

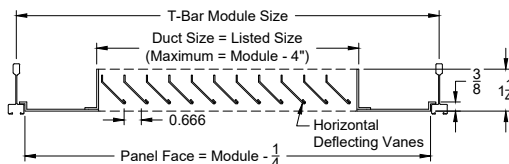

Note: This product complies with the requirements of NFPA 90A-18, Sections 4.3.7.3.2 & 4.3.8.3.2.

MODEL XG-RH

Return Grilles and Registers Aluminum - 45° Louvered Face

- Models:
- XG-RH-H-1** Return Grille - Surface Mount - Hinged Core
 - XG-RH-RC-1** Return Grille - Surface Mount - Removable Core
 - XG-RH-H-6** Return Grille - T-Bar Mount - Hinged Core
 - XG-RH-RC-6** Return Grille - T-Bar Mount - Removable Core

Model: XG-RH-H-1 - Aluminum Return Grille - Surface Mount - Hinged Core
 XG-RH-RC-1 - Aluminum Return Grille - Surface Mount - Removable Core

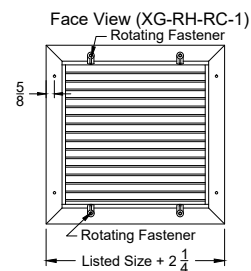
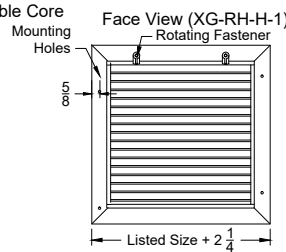
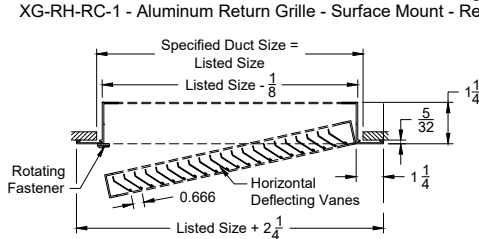

Model: XG-RH-H-6 - Aluminum Return Grille - T-Bar Mount - Hinged Core
 XG-RH-RC-6 - Aluminum Return Grille - T-Bar Mount - Removable Core

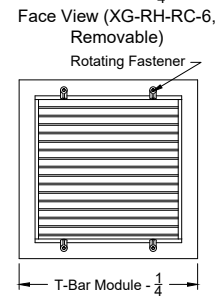
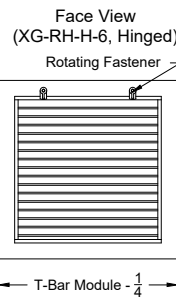
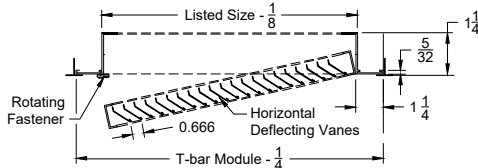

Damper Options

- XG-OBDD: Steel Opposed Blade Damper
- XG-OBDA: Aluminum Opposed Blade Damper

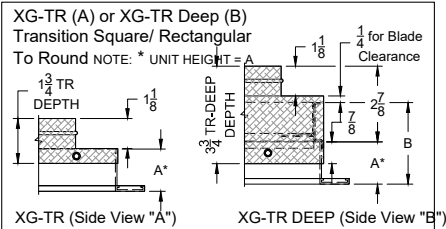
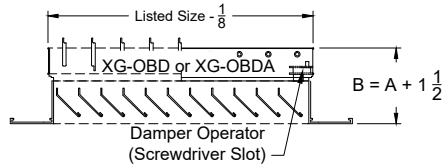

Notes: (check if provided)

Note: This product complies with the requirements of NFPA 90A-18, Sections 4.3.7.3.2 & 4.3.8.3.2.

1. Available Finishes	2. Available Accessories	3. Available Options	4. Construction Details
Standard Finish: <input type="checkbox"/> 01 White. Optional Finish (no extra charge): <input type="checkbox"/> 24 Mill Finish. Optional Finish (additional Charge): <input type="checkbox"/> 02 Satin Silver <input type="checkbox"/> 03 Black. <input type="checkbox"/> 28 Custom Color / Setup Charge	<input type="checkbox"/> XG-OBDD - Steel Opposed Blade Damper <input type="checkbox"/> XG-OBDA - Aluminum Opposed Blade Damper <input type="checkbox"/> XG-L9 - Equalizing Grid. <input type="checkbox"/> XG-PF - Plaster Frame. <input type="checkbox"/> XG-TBPF - T-Bar Plaster Frame <input type="checkbox"/> XG-TR - Transition Square / Rectangular to Round; Up To 22x22 listed size <input type="checkbox"/> XG-TR-Deep Transition Used With Dampers <input type="checkbox"/> XG-LIPF - Lay-In Plaster Frame	<input type="checkbox"/> IS - Insect Screen. <input type="checkbox"/> FGBP - Factory Installed R6 Insulation On 24x24 Panel Only Removable Core	<ul style="list-style-type: none"> ● Odd / Fractional Sizes Available. ● Oversized units made in multiple sections, each with full Flanged Mullion strips provided for joining units in field. ● Can be ordered to fit standard T-Bar sizes .

MODEL XG-RH-CM

Return Grilles and Registers Roll Formed Aluminum - 45° Louvered Face

Models: **XG-RH-1-CM** Return Grille - Concealed Mount

Model: XG-RH-1 CM (Return Grille - Surface Mount)

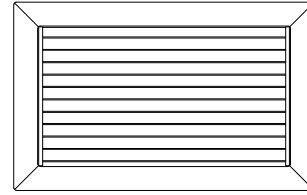
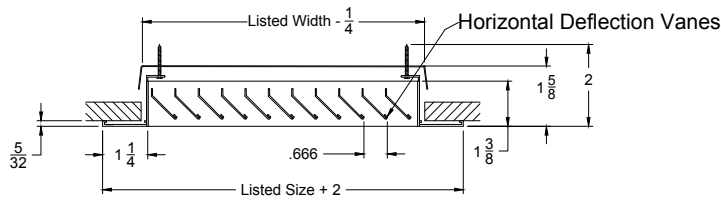

Face View (XG-RH-1 Model)

Model: XG-RH-1 CM -XG-OBD (Return Grille - Concealed Mounting)

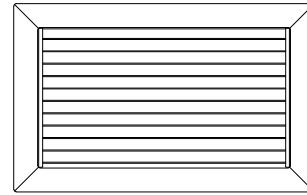
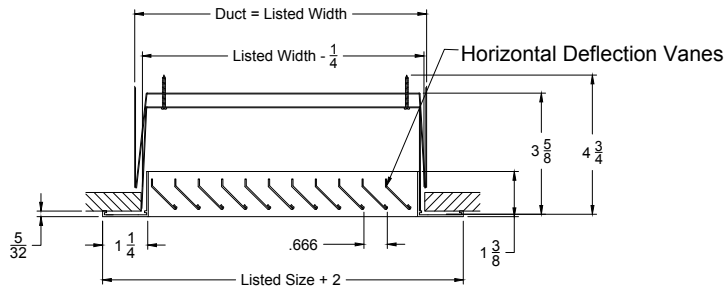

Face View (XG-RH-1 Model)

Notes: (check if provided)

1. Available Finishes	2. Available Accessories	3. Available Options	4. Construction Details
Standard Finish: <input type="checkbox"/> 01 White. Optional Finish (no extra charge): <input type="checkbox"/> 24 Mill Finish. Optional Finish (additional Charge): <input type="checkbox"/> 02 Satin Silver <input type="checkbox"/> 03 Black. <input type="checkbox"/> 28 Custom Color / Setup Charge	<input type="checkbox"/> XG-OBDA - Steel Opposed Blade Damper <input type="checkbox"/> XG-OBDA - Aluminum Opposed Blade	<input type="checkbox"/> IS - Insect Screen	

MODEL XG-RH

Return Grilles and Registers Aluminum - 45° Louvered Face

- Models:
- XG-RH-H-1** Return Grille - Surface Mount - Hinged Core
 - XG-RH-RC-1** Return Grille - Surface Mount - Removable Core
 - XG-RH-H-6** Return Grille - T-Bar Mount - Hinged Core
 - XG-RH-RC-6** Return Grille - T-Bar Mount - Removable Core

Model: XG-RH-H-1 - Aluminum Return Grille - Surface Mount - Hinged Core
 XG-RH-RC-1 - Aluminum Return Grille - Surface Mount - Removable Core

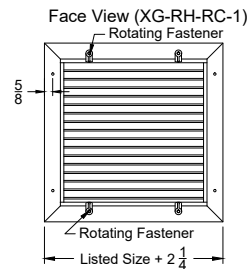
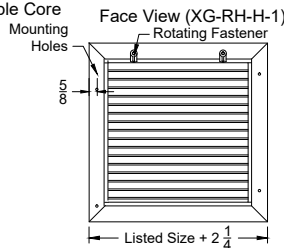
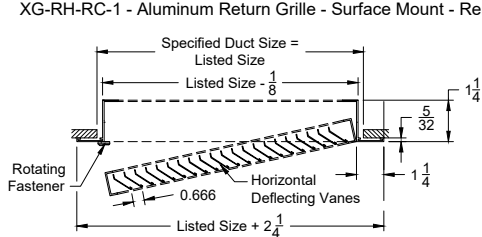

Model: XG-RH-H-6 - Aluminum Return Grille - T-Bar Mount - Hinged Core
 XG-RH-RC-6 - Aluminum Return Grille - T-Bar Mount - Removable Core

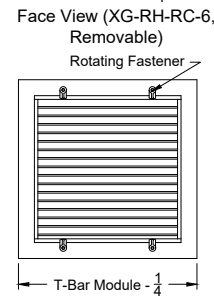
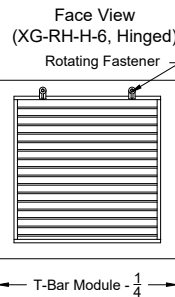
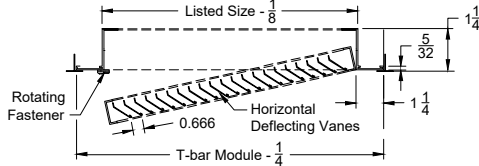

Damper Options

- XG-OBD: Steel Opposed Blade Damper
- XG-OBDA: Aluminum Opposed Blade Damper

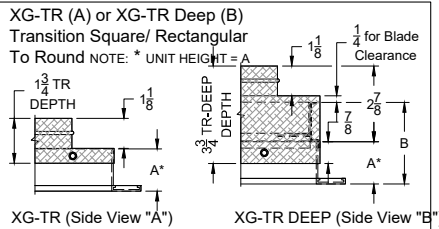
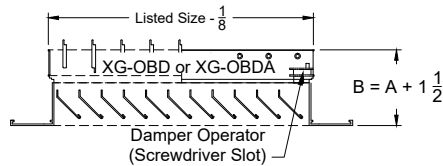

Notes: (check if provided)

Note: This product complies with the requirements of NFPA 90A-18, Sections 4.3.7.3.2 & 4.3.8.3.2.

1. Available Finishes	2. Available Accessories	3. Available Options	4. Construction Details
Standard Finish: <input type="checkbox"/> 01 White. Optional Finish (no extra charge): <input type="checkbox"/> 24 Mill Finish. Optional Finish (additional Charge): <input type="checkbox"/> 02 Satin Silver <input type="checkbox"/> 03 Black. <input type="checkbox"/> 28 Custom Color / Setup Charge	<input type="checkbox"/> XG-OBD - Steel Opposed Blade Damper <input type="checkbox"/> XG-OBDA - Aluminum Opposed Blade Damper <input type="checkbox"/> XG-L9 - Equalizing Grid. <input type="checkbox"/> XG-PF - Plaster Frame. <input type="checkbox"/> XG-TBPF - T-Bar Plaster Frame <input type="checkbox"/> XG-TR - Transition Square / Rectangular to Round; Up To 22x22 listed size <input type="checkbox"/> XG-TR-Deep Transition Used With Dampers <input type="checkbox"/> XG-LIPF - Lay-In Plaster Frame	<input type="checkbox"/> IS - Insect Screen. <input type="checkbox"/> FGFBP - Factory Installed R6 Insulation On 24x24 Panel Only Removable Core	<ul style="list-style-type: none"> ● Odd / Fractional Sizes Available. ● Oversized units made in multiple sections, each with full Flanged Mullion strips provided for joining units in field. ● Can be ordered to fit standard T-Bar sizes .

MODEL XG-RHE-CM

Return Grilles and Registers Roll Formed Aluminum - 45° Louvered Face

Models: **XG-RHE-1-CM** Return Grille - Concealed Mount

• Model: XG-RHE-1 CM (Return Grille - Surface Mount)

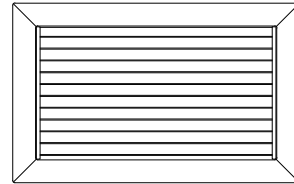
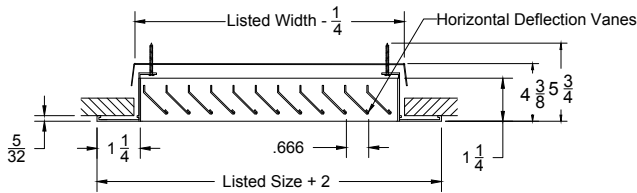

Face View (XG-RHE-1 Model)

• Model: XG-RHE-1 CM -XG-OBD (Return Grille - Concealed Mounting)

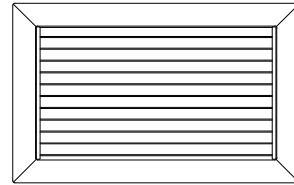
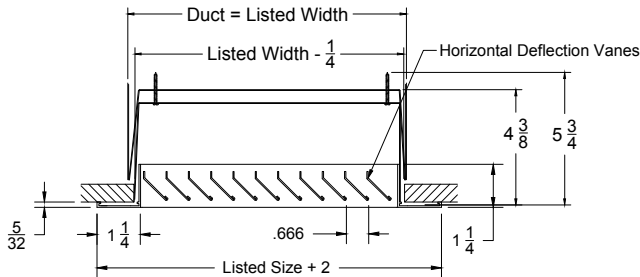

Face View (XG-RHE-1 Model)

Notes: (check if provided)

1. Available Finishes	2. Available Accessories	3. Available Options	4. Construction Details
Standard Finish: <input type="checkbox"/> 01 White. Optional Finish (no extra charge): <input type="checkbox"/> 24 Mill Finish. Optional Finish (additional Charge): <input type="checkbox"/> 02 Satin Silver <input type="checkbox"/> 03 Black. <input type="checkbox"/> 28 Custom Color / Setup Charge	<input type="checkbox"/> XG-OBDA - Steel Opposed Blade Damper <input type="checkbox"/> XG-OBDA - Aluminum Opposed Blade Damper <input type="checkbox"/> XG-L9 - Equalizing Grid	<input type="checkbox"/> IS - Insect Screen	

MODEL XG-RHE

Return Grilles and Registers Roll Formed - 45° Louvered Face

- Models:
- XG-RHE-1** Return Grille - Surface Mount
 - XG-RHE-6** Return Grille - Lay in T-Bar
 - XG-RHE-9** Return Grille - Bolt Slot Ceiling Grid

Model: XG-RHE-1 Return Grille - Surface Mount

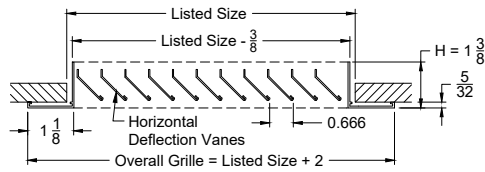

Face View (XG-RHE-1 Model)

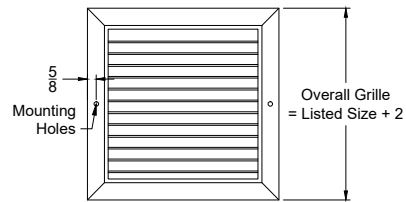

Model: XG-RHE-6 Return Grille - Lay in T-Bar

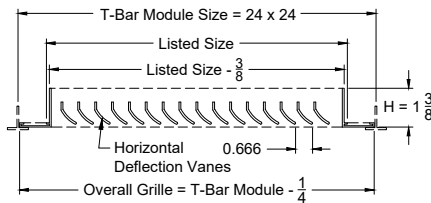

Face View (XG-RHE-6 Model)

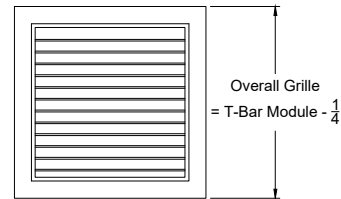

Model: XG-RHE-9 Aluminum Return Grille - Bolt Slot Ceiling Grid

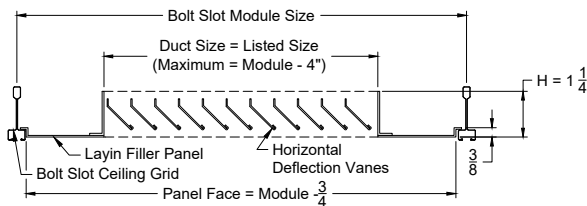

Face View (XG-RHE-9 Model)

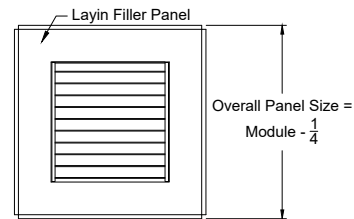

Note: This product complies with the requirements of NFPA 90A-18, Sections 4.3.7.3.2 & 4.3.8.3.2.

MODEL XG-RHE-H

Return Grilles and Registers Extruded Aluminum - 45° Louvered Face

- Models: **XG-RHE-H-1** Return Grille - Surface Mount - Hinged Core
 XG-RHE-RC-1 Return Grille - Surface Mount - Removable Core
 XG-RHE-H-6 Return Grille - T-Bar Mount - Hinged Core
 XG-RHE-RC-6 Return Grille - T-Bar Mount - Removable Core

Model: **XG-RHE-H-1** Aluminum Return Grille - Surface Mount - Hinged Core

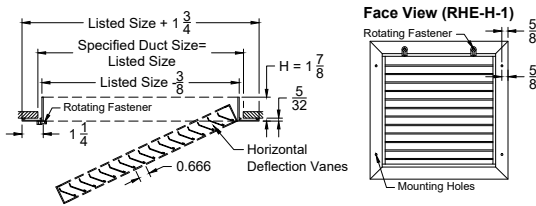

Model: **XG-RHE-RC-1** Return Grille - Surface Mount - Removable Core

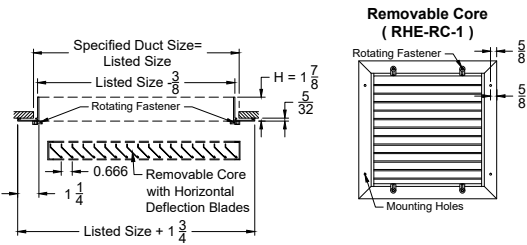

Model: **XG-RHE-H-6** Aluminum Return Grille - T-Bar Mount - Hinged Core

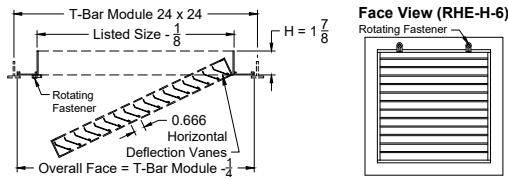

Model: **XG-RHE-RC-6** Return Grille - T-Bar Mount - Removable Core

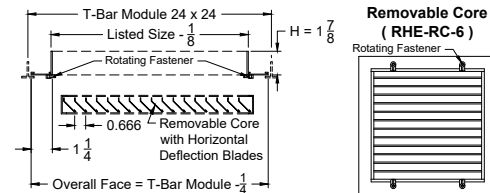

Options: **XG-OB**: Steel Opposed Blade Damper
XG-OBDA: Aluminum Opposed Blade Damper

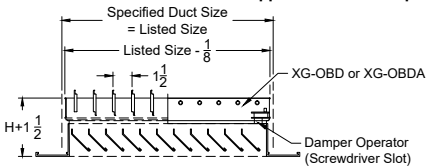

XG-TR (A) or XG-TR Deep (B)
 Transition Square/ Rectangular To Round

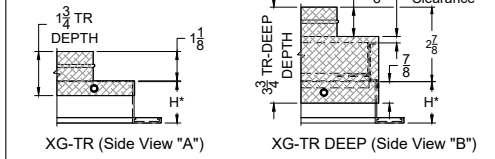

Notes: (check if provided)

Note: This product complies with the requirements of NFPA 90A-18, Sections 4.3.7.3.2 & 4.3.8.3.2.

1. Available Finishes	2. Available Accessories	3. Available Options	4. Construction Details
Standard Finish: <input type="checkbox"/> 01 White. Optional Finish (no extra charge): <input type="checkbox"/> 24 Mill Finish. Optional Finish (additional Charge): <input type="checkbox"/> 02 Satin Silver <input type="checkbox"/> 03 Black. <input type="checkbox"/> 28 Custom Color / Setup Charge	<input type="checkbox"/> XG-OB - Steel Opposed Blade Damper <input type="checkbox"/> XG-OBDA - Aluminum Opposed Blade Damper <input type="checkbox"/> XG-L9 - Equalizing Grid. <input type="checkbox"/> XG-PF - Plaster Frame. <input type="checkbox"/> XG-TBPF - T-Bar Plaster Frame <input type="checkbox"/> XG-TR - Transition Square / Rectangular to Round; Up To 22x22 listed size <input type="checkbox"/> XG-TR Deep - 1 1/2 Deep Transition <input type="checkbox"/> XG-LIPF - Lay-In Plaster Frame	<input type="checkbox"/> IS - Insect Screen. <input type="checkbox"/> FGBP - Factory Installed R6 Insulation On 24x24 Panel Only Removable Core	<ul style="list-style-type: none"> ● Odd / Fractional Sizes Available. ● Oversized units made in multiple sections, each with full Flanged Mullion strips provided for joining units in field. ● Can be ordered to fit standard T-Bar sizes. ● XG-RHE-9 Max Neck Size 20x20 Max Panel Size 24x24

SERIES XG-RH PERFORMANCE DATA
MODELS XG-RH, XG-RHE, XG-SRH, XG-RH-H, XG-RHE-H, XG-SRH-H

Size	Duct Area ft ²	Nk Vel	200	300	400	500	600	700	800	900	1000
		Ps	-.005	-.011	-.020	-.031	-.045	-.061	-.080	-.101	-.125
06x06	.25	CFM	50	75	100	125	150	175	200	225	250
		NC	-	-	14	17	20	22	25	27	29
08x06	.33	CFM	67	100	133	167	200	233	267	300	333
		NC	-	11	15	18	21	24	26	29	31
10x06	.42	CFM	83	125	167	208	250	292	333	375	417
		NC	-	12	16	19	22	25	27	29	32
08x08	.44	CFM	89	133	178	222	267	311	356	400	444
		NC	-	12	16	19	22	25	27	29	32
12x06	.50	CFM	100	150	200	250	300	350	400	450	500
		NC	-	13	17	20	23	25	28	30	32
16x06 12x08	.67	CFM	133	200	267	333	400	467	533	600	667
		NC	-	14	18	21	24	27	29	32	34
10x10	.69	CFM	139	208	278	347	417	486	556	625	694
		NC	10	14	18	21	24	27	29	32	34
12x10 20x06	.83	CFM	167	250	333	417	500	583	667	750	833
		NC	10	15	19	22	25	28	30	32	35
24x06 12x12	1.00	CFM	200	300	400	500	600	700	800	900	1000
		NC	11	16	20	23	26	28	31	33	35
14x12	1.16	CFM	233	250	467	583	7800	817	933	1050	1167
		NC	12	16	20	24	26	29	32	34	36
18x10 30x06	1.25	CFM	250	375	500	625	750	875	1000	1125	1250
		NC	12	17	21	24	27	29	32	34	36
14x14	1.36	CFM	272	408	544	681	817	953	1089	1225	1361
		NC	13	17	21	24	27	30	32	35	37
18x12 36x06	1.50	CFM	300	450	600	750	900	1050	1200	1350	1500
		NC	13	189	21	25	28	30	33	35	37
24x10 30x08	1.67	CFM	333	500	667	833	1000	1167	1333	1500	1667
		NC	13	18	22	25	28	31	33	34	38
18x14 42x06	1.75	CFM	350	525	700	875	1050	1225	1400	1575	1750
		NC	14	18	22	25	28	31	33	36	38
18x16 24x12	2.00	CFM	400	600	800	1000	1200	1400	1600	1800	2000
		NC	14	19	23	26	29	32	34	36	38
18x18	2.25	CFM	450	675	900	1125	1350	1575	1800	2025	2250
		NC	15	19	23	26	29	32	34	37	39

CONTINUED

SERIES XG-RH PERFORMANCE DATA**MODELS XG-RH, XG-RHE, XG-SRH, XG-RH-H, XG-SRH-H**

Size	Duct Area ft ²	Nk Vel	200	300	400	500	600	700	800	900	1000
		Ps	-0.005	-0.011	-0.020	-0.031	-0.045	-0.061	-0.080	-0.101	-0.125
30x12	2.50	CFM	500	750	1000	1250	1500	1750	2000	2250	2500
		NC	15	20	24	27	30	32	35	37	39
20x20	2.78	CFM	556	833	1111	1389	1667	1944	2222	2500	2778
		NC	16	20	24	27	30	33	35	38	40
24x18 36x12	3.00	CFM	600	900	1200	1500	1800	2100	2400	2700	3000
		NC	16	21	24	28	31	33	36	38	40
22x22	3.36	CFM	672	1008	1344	1681	2017	2353	2689	3025	3361
		NC	17	21	25	28	31	34	36	39	41
36x14 42x12	3.50	CFM	700	1050	1400	1750	2100	2450	2800	3150	3500
		NC	17	21	25	28	31	34	36	39	41

**PERFORMANCE NOTES FOR SERIES XG-RH, XG-RHE, XG-SRH, XG-RH-H,
XG-SRH-H**

All data is tested in accordance with ANSI/ASHRAE 70-2006.

DEFINITION OF UNITS

CFM Cubic Feet per Minute (air)

Velocity Velocity of air stream in Feet per Minute

Ps Static pressure = Pt-Pv (inches of water column)

NC Noise criterion, Sound pressure level. NC ratings are based on sound power level (lw)

RE: 10⁻¹² watts minus a 10dB room attenuation in all octave bands.

Nk Vel Neck velocity of air stream in Feet Per Minute

CONTINUED

SERIES XG-RH PERFORMANCE DATA
MODELS XG-RH, XG-RHE, XG-SRH, XG-RH-H, XG-SRH-H

Size	Duct Area ft ²	Nk Vel	200	300	400	500	600	700	800	900	1000
		Ps	-.009	-.020	-.036	-.056	-.081	-.110	-.143	-.181	-.223
24x22	3.67	CFM	733	1100	1467	1833	2200	2567	2933	3300	3667
		NC	17	21	25	29	31	34	37	39	41
30x18	3.75	CFM	750	1125	1500	1875	2250	2625	3000	3375	3750
		NC	17	22	25	29	32	34	37	39	41
48x12 24x24	4.00	CFM	800	1200	1600	2000	2400	2800	3200	3600	XG-4000
		NC	17	22	26	29	32	35	37	39	41
30x20	4.17	CFM	833	1250	1667	2083	2500	2917	3333	3750	4167
		NC	17	22	26	29	32	35	37	39	42
36x18	4.50	CFM	900	1350	1800	2250	2700	3150	3600	4050	4500
		NC	18	22	26	29	32	35	37	40	42
36x20 30x24	5.00	CFM	1000	1500	2000	2500	3000	3500	XG-4000	4500	5000
		NC	18	23	27	30	33	35	38	40	42
42x18	5.25	CFM	1050	1575	2100	2625	3150	3675	4200	4725	5250
		NC	18	23	27	30	33	36	38	40	43
28x28	5.44	CFM	1089	1633	2178	2722	3267	3811	4356	4900	5444
		NC	19	23	27	30	33	36	38	41	43
36x22	5.50	CFM	1100	1650	2200	2750	3300	3850	4400	4950	5500
		NC	19	23	27	30	33	36	38	41	43
48x18 36x24	6.00	CFM	1200	1800	2400	3000	3600	4200	4800	5400	6000
		NC	19	24	27	31	34	36	39	41	43
48x24 36x32	8.00	CFM	1600	2400	3200	XG-4000	4800	5600	6400	7200	8000
		NC	20	25	29	32	35	38	40	42	44
40x36 48x30	10.00	CFM	2000	3000	XG-4000	5000	6000	7000	8000	9000	10000
		NC	21	26	30	33	36	38	41	43	45
38x38	10.03	CFM	2006	3008	4011	5014	6017	7019	8022	9025	10028
		NC	21	26	30	33	36	39	41	43	45
42x36	10.50	CFM	2100	3150	4200	5250	6300	7350	8400	9450	10500
		NC	21	26	30	33	36	39	41	43	46
46x34	10.86	CFM	2172	3258	4344	5431	6517	7603	8689	9775	10861
		NC	22	26	30	33	36	39	41	44	46
42x38	11.08	CFM	2217	3325	4433	5542	6650	7758	8867	9975	11083
		NC	22	26	30	33	36	39	41	44	46
40x40	11.11	CFM	2222	3333	4444	5556	6667	7778	8889	10000	11111
		NC	22	26	30	33	36	39	41	44	46

CONTINUED

SERIES XG-RH PERFORMANCE DATA**MODELS XG-RH, XG-RHE, XG-SRH, XG-RH-H, XG-SRH-H**

Size	Duct Area ft ²	Nk Vel	200	300	400	500	600	700	800	900	1000
		Ps	-0.005	-0.011	-0.020	-0.031	-0.045	-0.061	-0.080	-0.101	-0.125
30x12	2.50	CFM	500	750	1000	1250	1500	1750	2000	2250	2500
		NC	15	20	24	27	30	32	35	37	39
20x20	2.78	CFM	556	833	1111	1389	1667	1944	2222	2500	2778
		NC	16	20	24	27	30	33	35	38	40
24x18 36x12	3.00	CFM	600	900	1200	1500	1800	2100	2400	2700	3000
		NC	16	21	24	28	31	33	36	38	40
22x22	3.36	CFM	672	1008	1344	1681	2017	2353	2689	3025	3361
		NC	17	21	25	28	31	34	36	39	41
36x14 42x12	3.50	CFM	700	1050	1400	1750	2100	2450	2800	3150	3500
		NC	17	21	25	28	31	34	36	39	41

PERFORMANCE NOTES FOR SERIES XG-RH, XG-RHE, XG-SRH, XG-RH-H, XG-SRH-H

All data is tested in accordance with ANSI/ASHRAE 70-2006.

DEFINITION OF UNITS

CFM Cubic Feet per Minute (air)

Velocity Velocity of air stream in Feet per Minute

Ps Static pressure = $P_t - P_v$ (inches of water column)

NC Noise criterion, Sound pressure level. NC ratings are based on sound power level (lw)
 RE: 10^{-12} watts minus a 10dB room attenuation in all octave bands.

Nk Vel Neck velocity of air stream in Feet Per Minute

MODEL XG-4002R

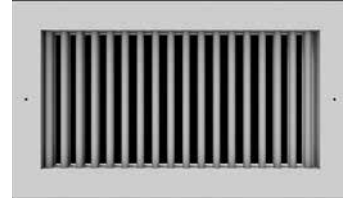

Return Grilles – Aluminum/Model XG-4002R

Air Inlets shall be model XG-V40002R (vertical blades) or XG-H4002R (horizontal blades) manufactured by GREENHECK. Units shall be return or exhaust grilles of aluminum construction and with an extruded aluminum border and a single set of deflection blades. Air inlets to be specifically designed to match the appearance of the supply units, GREENHECK Series 4000. The units shall be the size and quantity as outlined in the plans and specifications.

Border shall be 1 1/4" wide with aerodynamically shaped deflector blades on .666" centers set at 0° (or 45°). Deflector blades shall be fixed. Units shall be designed for surface mounting applications and be provided with counter sunk screw holes on the face of the device.

Return Grilles – Steel/Model XG-4002RS

Air Inlets shall be model XG-V40002RS (vertical blades) or XG-H4002RS (horizontal blades) manufactured by GREENHECK. Units shall be return or exhaust grilles of steel construction and with a single set of deflection blades. Air inlets to be specifically designed to match the appearance of the supply units, GREENHECK Series 4000. The units shall be the size and quantity as outlined in the plans and specifications.

Border shall be 1 1/4" wide with aerodynamically shaped deflector blades on .666" centers set at 0° (or 40°). Deflector blades shall be fixed. Units shall be designed for surface mounting applications and be provided with counter sunk screw holes on the face of the device.

Damper Accessories (Optional)

Optional opposed blade damper shall be constructed of steel (Model XG-OBD) or aluminum (Model XG-OBDA). Damper must be operable from the face of the diffuser.

Performance Specification

The manufacturer shall provide published performance data. Data shall be tested in accordance to ANSI/ASHRAE Standard 70- 2006

MODEL XG-4002R

Return Grilles and Registers Aluminum - Fixed Blades 0° Deflection or 40° Deflection

XG-V4002R-1 XG-H4002R-1 Sidewall Return Grille - Surface Mount (V-Vertical Or H-Horizontal Blades)
XG-V4002R-6 XG-H4002R-6 Ceiling Return Grille - Lay In T-Bar (V-Vertical Or H-Horizontal Blades)

Model: XG-H4002R-1 (Sidewall Return Grille - Surface Mount)
(Horizontal Fixed Blades)

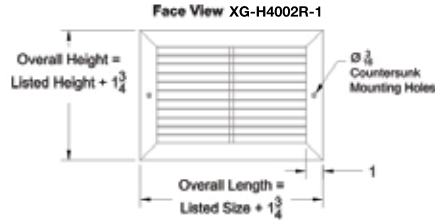

Model: XG-V4002R-1 (Sidewall Return Grille - Surface Mount)
(Vertical Fixed Blades)

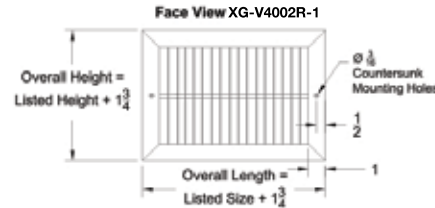
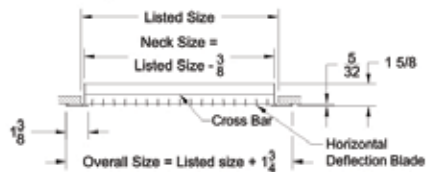

Model: XG-4002R-6 (Ceiling Return Grille - Lay In T-Bar)
(V-Vertical Or H-Horizontal Fixed Blades)

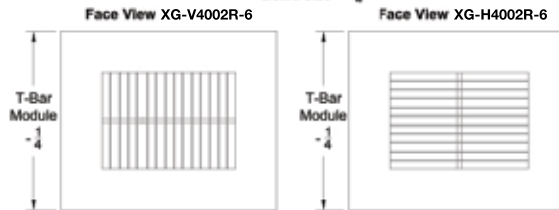

Model: XG-V4002R-1 or XG-H4002R-1 (Sidewall Return Register)
(V-Vertical Or H-Horizontal Fixed Blades)
(With Opposed Blade Damper)

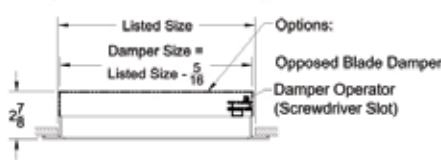

Model: XG-V4002R-6 or XG-H4002R-6 (Ceiling Return Register - Lay In T-Bar)
(V-Vertical Or H-Horizontal Fixed Blades)
(With Opposed Blade Damper)

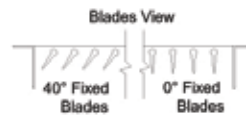
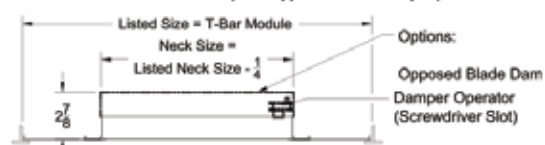

MODEL XG-4002R

Return Grilles and Registers Steel - Fixed Blades

Models: **XG-H4002RS-1-CM** Sidewall Return Grille - Concealed Mount
XG-H4002RS-1-CM-OBD Sidewall Return Grille - Concealed Mount - With OBD

**Series XG-4000, Model: XG-4002RS-CM
(Steel Construction - Concealed Mount)**

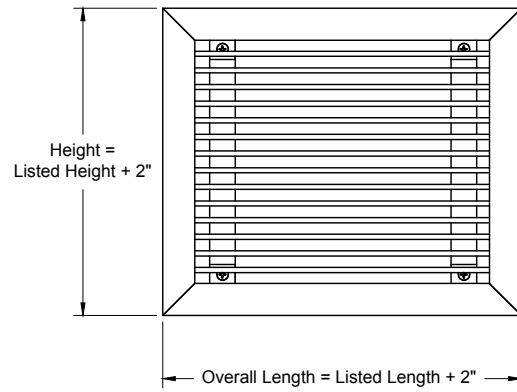
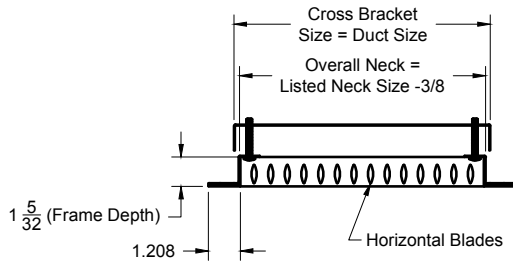

**Series XG-4000, Model: XG-4002RS-CM-With OBD
(Steel Construction - Concealed Mount)**

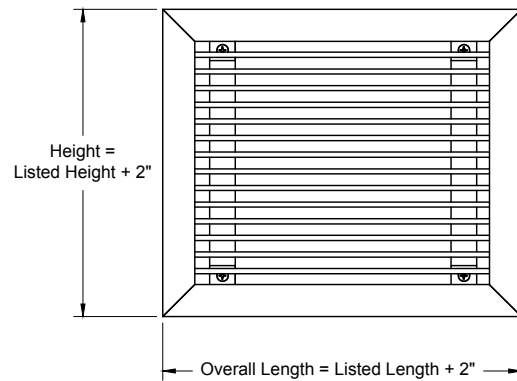
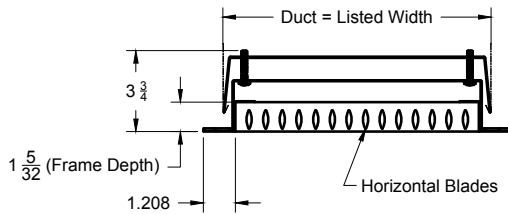

XG-4000 MODEL NUMBER SPECIFICATION
SIDEWALL RETURN GRILLE — SURFACE MOUNT

Model		Neck											
		6	8	10	12	14	16	18	20	22	24	26	
XG-V4002R-1	Al. - Vertical Blade												
XG-H4002R-1	Al. - Horizontal Blade	4	X	X	X	X	X	X	X	X	X	X	
XG-V4002RS-1	Steel - Vertical Blade	5	X	X	X	X	X	X	X	X	X	X	
XG-H4002RS-1	Steel - Horizontal Blade	6	X	X	X	X	X	X	X	X	X	X	
		8	X	X	X	X	X	X	X	X	X	X	
		10	X	X	X	X	X	X	X	X	X	X	
		12	X	X	X	X	X	X	X	X	X	X	
		14	X	X	X	X	X	X	X	X	X	X	
		16	X	X	X	X	X	X	X	X	X	X	
		18	X	X	X	X	X	X	X	X	X	X	
		20	X	X	X	X	X	X	X	X	X	X	
		22	X	X	X	X	X	X	X	X	X	X	
		24	X	X	X	X	X	X	X	X	X	X	
		26	X	X	X	X	X	X	X	X	X	X	
		28	X	X	X	X	X	X	X	X	X	X	
		30	X	X	X	X	X	X	X	X	X	X	
		32	X	X	X	X	X	X	X	X	X	X	
		34	X	X	X	X	X	X	X	X	X	X	
		36	X	X	X	X	X	X	X	X	X	X	
		38	X	X	X	X	X	X	X	X	X	X	
		40	X	X	X	X	X	X	X	X	X	X	
		42	X	X	X	X	X	X	X	X	X	X	
		44	X	X	X	X	X	X	X	X	X	X	
		46	X	X	X	X	X	X	X	X	X	X	
		48	X	X	X	X	X	X	X	X	X	X	

Available Finishes		Available Accessories	
Standard		XG-OB	Steel Opposed Blade Damper
01	White	XG-OBDA	Aluminum Opposed Blade Damper
Optional		XG-L9	Equalizing Grid
02	Satin Silver	XG-PF	Plaster Frame
03	Black	XG-LIPF	Lay-in Plaster Frame
04	Clear Anodize	XG-IS	Insect Screen
24	Mill (Aluminum Construction Only)	XG-TR	Square to Round Transition

Available Options	
XG-NSH	No Screw Holes
XG-CM	Concealed Mounting

**XG-4000 MODEL NUMBER SPECIFICATION
SIDEWALL RETURN GRILLE — SURFACE MOUNT**

Model		Neck											
		28	30	32	34	36	38	40	42	44	46	48	
XG-V4002R-1	Al. - Vertical Blade												
XG-H4002R-1	Al. - Horizontal Blade	4	X	X	X	X	X	X	X	X	X	X	
XG-V4002RS-1	Steel - Vertical Blade	5	X	X	X	X	X	X	X	X	X	X	
XG-H4002RS-1	Steel - Horizontal Blade	6	X	X	X	X	X	X	X	X	X	X	
		8	X	X	X	X	X	X	X	X	X	X	
		10	X	X	X	X	X	X	X	X	X	X	
		12	X	X	X	X	X	X	X	X	X	X	
		14	X	X	X	X	X	X	X	X	X	X	
		16	X	X	X	X	X	X	X	X	X	X	
		18	X	X	X	X	X	X	X	X	X	X	
		20	X	X	X	X	X	X	X	X	X	X	
		22	X	X	X	X	X	X	X	X	X	X	
		24	X	X	X	X	X	X	X	X	X	X	
		26	X	X	X	X	X	X	X	X	X	X	
		28	X	X	X	X	X	X	X	X	X	X	
		30	X	X	X	X	X	X	X	X	X	X	
		32	X	X	X	X	X	X	X	X	X	X	
		34	X	X	X	X	X	X	X	X	X	X	
		36	X	X	X	X	X	X	X	X	X	X	
		38	X	X	X	X	X	X	X	X	X	X	
		40	X	X	X	X	X	X	X	X	X	X	
		42	X	X	X	X	X	X	X	X	X	X	
		44	X	X	X	X	X	X	X	X	X	X	
		46	X	X	X	X	X	X	X	X	X	X	
		48	X	X	X	X	X	X	X	X	X	X	

Available Finishes		Available Accessories	
Standard		XG-OB	Steel Opposed Blade Damper
01	White	XG-OBDA	Aluminum Opposed Blade Damper
Optional		XG-L9	Equalizing Grid
02	Satin Silver	XG-PF	Plaster Frame
03	Black	XG-LIPF	Lay-in Plaster Frame
04	Clear Anodized	XG-IS	Insect Screen
24	Mill (Aluminum Construction Only)	XG-TR	Square to Round Transition

Available Options	
XG-NSH	No Screw Holes
XG-CM	Concealed Mounting

XG-4000 MODEL NUMBER SPECIFICATION
SIDEWALL RETURN GRILLE — LAY-IN

Model		Neck											Module
		6	8	10	12	14	16	18	20	22	24		
XG-V4002R-6	Al. - Vertical Blade												12 x 12
XG-H4002R-6	Al. - Horizontal Blade - Single Def.	4	X	X									
XG-V4002RS-6	Steel - Vertical Blade - Single Def.	6	X	X									
XG-H4002RS-6	Steel - Horizontal Blade - Single Def.	8	X	X									
		10			X								24 x 12
		4	X	X	X	X	X	X	X	X			
		6	X	X	X	X	X	X	X	X			
		8	X	X	X	X	X	X	X	X			
		10								X			24 x 24
		4	X	X	X	X	X	X	X	X			
		6	X	X	X	X	X	X	X	X			
		8	X	X	X	X	X	X	X	X			
		10	X	X	X	X	X	X	X	X			
		12	X	X	X	X	X	X	X	X			
		14	X	X	X	X	X	X	X	X			
		16	X	X	X	X	X	X	X	X			
		18	X	X	X	X	X	X	X	X			
		20	X	X	X	X	X	X	X	X			
		22								X			48 x 24
		4	X	X	X	X	X	X	X	X	X		
		6	X	X	X	X	X	X	X	X	X		
		8	X	X	X	X	X	X	X	X	X		
		10	X	X	X	X	X	X	X	X	X		
		12	X	X	X	X	X	X	X	X	X		
		14	X	X	X	X	X	X	X	X	X		
		16	X	X	X	X	X	X	X	X	X		
		18	X	X	X	X	X	X	X	X	X		
		20	X	X	X	X	X	X	X	X	X		

Available Finishes		Available Accessories	
Standard		XG-OB	Steel Opposed Blade Damper
01	White	XG-OBDA	Aluminum Opposed Blade Damper
Optional		XG-L9	Equalizing Grid
02	Satin Silver	XG-TBPF	T-bar Plaster Frame
03	Black	XG-IS	Insect Screen
24	Mill (Alum. Construction Only)	XG-TR	Square to Round Transition
28	Custom Color	XG-TR Deep	Deep Square to Round Transition

**XG-4000 MODEL NUMBER SPECIFICATION
SIDEWALL RETURN GRILLE — SURFACE MOUNT**

Model		Neck											
		28	30	32	34	36	38	40	42	44	46	48	
XG-V4002R-1	Al. - Vertical Blade												
XG-H4002R-1	Al. - Horizontal Blade	4	X	X	X	X	X	X	X	X	X	X	
XG-V4002RS-1	Steel - Vertical Blade	5	X	X	X	X	X	X	X	X	X	X	
XG-H4002RS-1	Steel - Horizontal Blade	6	X	X	X	X	X	X	X	X	X	X	
		8	X	X	X	X	X	X	X	X	X	X	
		10	X	X	X	X	X	X	X	X	X	X	
		12	X	X	X	X	X	X	X	X	X	X	
		14	X	X	X	X	X	X	X	X	X	X	
		16	X	X	X	X	X	X	X	X	X	X	
		18	X	X	X	X	X	X	X	X	X	X	
		20	X	X	X	X	X	X	X	X	X	X	
		22	X	X	X	X	X	X	X	X	X	X	
		24	X	X	X	X	X	X	X	X	X	X	
		26	X	X	X	X	X	X	X	X	X	X	
		28	X	X	X	X	X	X	X	X	X	X	
		30	X	X	X	X	X	X	X	X	X	X	
		32	X	X	X	X	X	X	X	X	X	X	
		34	X	X	X	X	X	X	X	X	X	X	
		36	X	X	X	X	X	X	X	X	X	X	
		38	X	X	X	X	X	X	X	X	X	X	
		40	X	X	X	X	X	X	X	X	X	X	
		42	X	X	X	X	X	X	X	X	X	X	
		44	X	X	X	X	X	X	X	X	X	X	
		46	X	X	X	X	X	X	X	X	X	X	
		48	X	X	X	X	X	X	X	X	X	X	

Available Finishes		Available Accessories	
Standard		XG-OB	Steel Opposed Blade Damper
01	White	XG-OBDA	Aluminum Opposed Blade Damper
Optional		XG-L9	Equalizing Grid
02	Satin Silver	XG-PF	Plaster Frame
03	Black	XG-LIPF	Lay-in Plaster Frame
04	Clear Anodized	XG-IS	Insect Screen
24	Mill (Aluminum Construction Only)	XG-TR	Square to Round Transition

Available Options	
XG-NSH	No Screw Holes
XG-CM	Concealed Mounting

XG-4000 MODEL NUMBER SPECIFICATION
SIDEWALL RETURN GRILLE — LAY-IN

Model		Neck										Module	
		6	8	10	12	14	16	18	20	22	24		
XG-V4002R-6	Al. - Vertical Blade												12 x 12
XG-H4002R-6	Al. - Horizontal Blade - Single Def.	4	X	X									
XG-V4002RS-6	Steel - Vertical Blade - Single Def.	6	X	X									
XG-H4002RS-6	Steel - Horizontal Blade - Single Def.	8	X	X									
		10			X								24 x 12
		4	X	X	X	X	X	X	X				
		6	X	X	X	X	X	X	X	X			
		8	X	X	X	X	X	X	X	X			
		10								X			24 x 24
		4	X	X	X	X	X	X	X	X			
		6	X	X	X	X	X	X	X	X			
		8	X	X	X	X	X	X	X	X			
		10	X	X	X	X	X	X	X	X			
		12	X	X	X	X	X	X	X	X			
		14	X	X	X	X	X	X	X	X			
		16	X	X	X	X	X	X	X	X			
		18	X	X	X	X	X	X	X	X			
		20	X	X	X	X	X	X	X	X			
		22								X			48 x 24
		4	X	X	X	X	X	X	X	X	X		
		6	X	X	X	X	X	X	X	X	X		
		8	X	X	X	X	X	X	X	X	X		
		10	X	X	X	X	X	X	X	X	X		
		12	X	X	X	X	X	X	X	X	X		
		14	X	X	X	X	X	X	X	X	X		
		16	X	X	X	X	X	X	X	X	X		
		18	X	X	X	X	X	X	X	X	X		
		20	X	X	X	X	X	X	X	X	X		

Available Finishes		Available Accessories	
Standard		XG-OB	Steel Opposed Blade Damper
01	White	XG-OBDA	Aluminum Opposed Blade Damper
Optional		XG-L9	Equalizing Grid
02	Satin Silver	XG-TBPF	T-bar Plaster Frame
03	Black	XG-IS	Insect Screen
24	Mill (Alum. Construction Only)	XG-TR	Square to Round Transition
28	Custom Color	XG-TR Deep	Deep Square to Round Transition

SERIES XG-4002R PERFORMANCE DATA
MODELS XG-H4002R, XG-V4002R, XG-H4002RS, XG-V4002RS

Size	Duct Area ft ²	Nk Vel	100	200	300	400	500	600	700	800	900
		Ps	-0.002	-0.009	-0.020	-0.035	-0.055	-0.080	-0.109	-0.142	-0.180
06x06	.25	CFM	19	38	57	77	96	115	134	153	172
		NC	-	-	-	14	20	25	29	32	35
08x06	.33	CFM	27	53	79	106	132	159	185	212	238
		NC	-	-	-	16	22	26	30	34	37
08x08	.44	CFM	37	73	110	146	183	219	256	292	329
		NC	-	-	-	17	23	28	32	35	38
12x06	.50	CFM	41	82	123	164	205	246	287	328	369
		NC	-	-	-	18	23	28	32	36	39
16x06 12x08	.67	CFM	56	111	167	222	278	334	389	445	501
		NC	-	-	12	19	25	29	33	37	40
12x10	.83	CFM	72	144	217	289	361	434	506	578	651
		NC	-	-	13	20	26	31	35	38	41
24x06 12x12	1.00	CFM	85	170	255	339	424	509	594	678	763
		NC	-	-	13	21	27	31	35	39	42
14x12	1.16	CFM	104	208	311	415	518	622	725	829	932
		NC	-	-	14	22	27	32	36	40	43
14x14	1.36	CFM	122	244	366	488	610	731	853	975	1097
		NC	-	-	15	22	28	33	37	40	43
24x12 18x16	2.00	CFM	182	364	545	727	909	1090	1273	1453	1635
		NC	-	-	17	24	30	35	39	42	45
18x18	2.25	CFM	206	413	620	826	1033	1240	1447	1653	1860
		NC	-	-	17	25	30	35	39	43	46
24x18	3.00	CFM	278	557	835	1114	1392	1671	1949	2228	2506
		NC	-	12	19	26	32	36	40	44	47
48x12 24x24	4.00	CFM	368	738	1107	1478	1846	2216	2585	2955	3324
		NC	-	12	20	27	33	38	42	45	48
30x20	4.17	CFM	390	781	1173	1564	1955	2346	2738	3129	3520
		NC	-	13	20	28	33	38	42	45	48
36x20 30x24	5.00	CFM	469	940	1412	1883	2355	2826	3297	3769	4240
		NC	-	14	21	28	34	39	43	46	49
36x22	5.50	CFM	520	1040	1560	2080	2600	3120	3640	4160	4680
		NC	-	14	21	29	34	39	43	47	50
48x18 36x24	6.00	CFM	566	1132	1698	2264	2831	3397	3963	4529	5095
		NC	-	14	22	29	35	40	44	47	50
48x24 36x32	8.00	CFM	760	1523	2287	3050	3813	4576	5340	6103	6866
		NC	-	15	23	30	36	41	45	48	51

CONTINUED

SERIES XG-4002R PERFORMANCE DATA

MODELS XG-H4002R, XG-V4002R, XG-H4002RS, XG-V4002RS

Size	Duct Area ft ²	Nk Vel	100	200	300	400	500	600	700	800	900
		Ps	-0.002	-0.009	-0.020	-0.035	-0.055	-0.080	-0.109	-0.142	-0.180
48x30 42x34	10.00	CFM	960	1920	2880	3840	4800	5760	6720	7680	8640
		NC	-	15	24	31	37	42	46	49	52
48x36	12.00	CFM	1160	2316	3473	4629	5785	6941	8098	9254	10410
		NC	-	16	25	32	38	43	47	50	53
48x40	13.33	CFM	1290	2578	3865	5153	6440	7728	9015	10303	11590
		NC	-	16	25	33	38	43	47	51	54
48x48	16.00	CFM	1550	3100	4650	6200	7750	9300	10850	12400	13950
		NC	-	17	26	33	39	44	48	51	54

PERFORMANCE NOTES FOR SERIES XG-4002R

All data is tested in accordance with ANSI/ASHRAE 70-2006.

DEFINITION OF UNITS

CFM Cubic Feet per Minute (air)

Ps Static pressure = Pt-Pv (inches of water column)

Nk Vel Neck velocity of air stream in Feet Per Minute

NC Noise criterion, sound pressure level NC ratings are based on sound power level (Lw) RE: 10⁻¹² watts minus a 10dB room attenuation in all octave bands.

MODEL XG-CC5

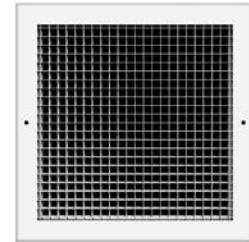

Return Grilles – Cubed Core – Aluminum

XG-CC5-1 – Surface Mount

XG-CC5-6 – T-bar Lay-in

XG-CC5 TBC-6 – T-bar Lay-in Channel Border

XG-CC5-7 – Concealed Spline

XG-CC5-8 – Tegular T-bar

XG-CC5-9 – Donn Finline

Air Inlets shall be model:

XG-CC5 with a 1/2" x 1/2" x 1/2" cubed core

XG-CC15 with a 1/2" x 1/2" x 1" cubed core

XG-CC1 with a 1" x 1" x 1" cubed core

Manufactured by GREENHECK. Border shall be 1 1/4" wide. Units shall be return or exhaust grilles of aluminum construction and with an extruded aluminum border and an aluminum cubed core. The units shall be the size and quantity as outlined in the plans and specifications.

Units shall be designed to integrate into the specified ceiling system.

For Surface mounting:

Units shall be designed for surface mounting applications and be provided with counter sunk screw holes on the face of the device.

For T-Bar Lay-in:

Units shall be designed to integrate into the specified ceiling system.

Damper Accessories (Optional)

Optional opposed blade damper shall be constructed of steel (model XG-OBD) or aluminum (model XG-OBDA). Damper must be operable from the face of the diffuser.

Performance Specification:

The manufacturer shall provide published performance data. Data shall be tested in accordance to ANSI/ASHRAE Standard 70- 2006

Paint Specification:

Process shall be anodic electrodeposition using an anodic acrylic paint. Units shall undergo pre-treatment including a pressurized spray stage using an alkaline cleaner and a de-ionized water rinse.

MODEL XG-CC5

Sidewall / Ceiling Return Grilles and Registers Extruded Aluminum - 1/2" x 1/2" x 1/2" Core

- Models:
- XG-CC5-1** Sidewall / Ceiling Return Grille - Surface Mount
 - XG-CC5-6** Ceiling Return Grille - Lay in T-Bar
 - XG-CC5-7** Sidewall / Ceiling Return Grille - Concealed Spline
 - XG-CC5-8** Sidewall / Ceiling Return Grille - Tegular Lay In T-Bar
 - XG-CC5-9** Sidewall / Ceiling Return Grille - Bolt Slot Ceiling Grid

Model: **XG-CC5-1 - Sidewall / Ceiling Return Grille - Surface Mount**

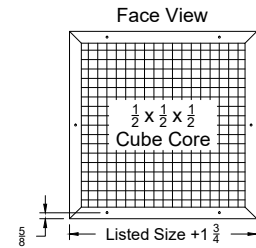
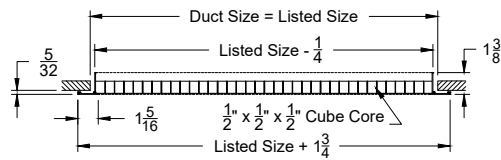

Model: **XG-CC5-6 - Ceiling Return Grille - Lay in T-Bar**

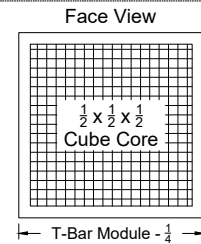
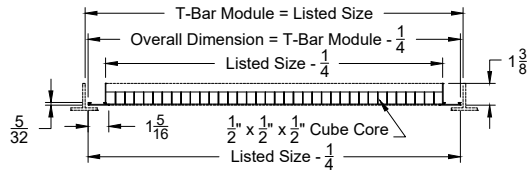

Model: **XG-CC5-7 - Ceiling Return Grille - Concealed T-Bar**

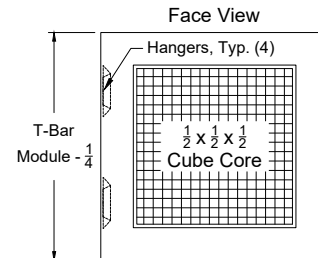
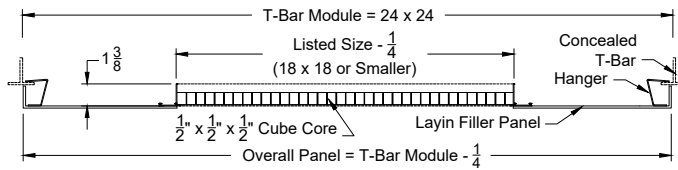

Model: **XG-CC5-8 - Ceiling Return Grille - Tegular Lay in T-Bar**

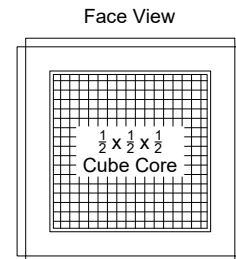
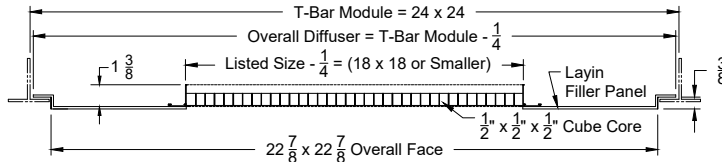

Model: **XG-CC5-9 - Ceiling Return Grille - Bolt Slot Ceiling Grid**

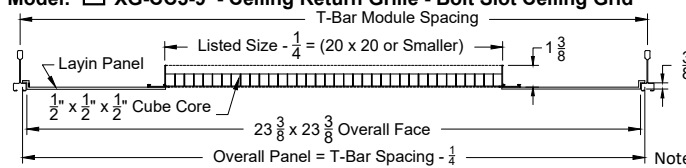

Note: This product complies with the requirements of NFPA 90A-18, Sections 4.3.7.3.2 & 4.3.8.3.2.

MODEL XG-CC5

Sidewall / Ceiling Return Grilles and Registers Extruded Aluminum - 1/2" x 1/2" x 1/2" Core

- Models: **XG-CC5R-6** Sidewall / Ceiling Return Grille - Lay in T-Bar - Removable Core
 XG-CC5-TBC-6 Sidewall / Ceiling Return Grille - Lay in T-Bar - Channel Frame

Model: **XG-CC5-TBC-6 - Sidewall Return Grille
Lay in T-Bar - Channel Frame**

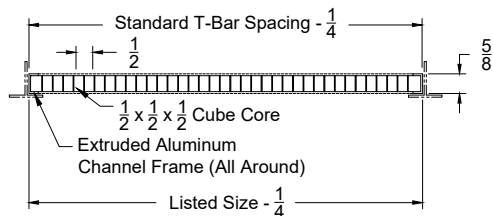

Face View XG-CC5-6

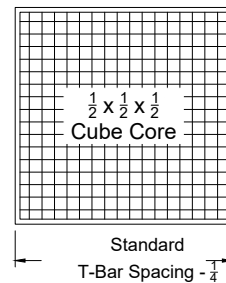

Model: **XG-CC5R-6 - Ceiling Return Grille
Lay in T-Bar - Removable Core**

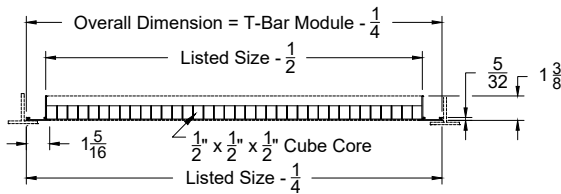

Face View XG-CC5R-6

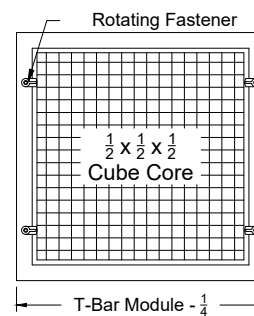

Note: This product complies with NFPA 90A standard 4.3.7.3.2 and 4.3.8.3.2 and is constructed with openings through which a 1/2" sphere cannot pass.

Notes: (check if provided)

1. Available Finishes	2. Available Accessories	3. Available Options	4. Construction Details
Standard Finish: <input type="checkbox"/> 01 White. Optional Finish (no extra Charge): <input type="checkbox"/> 24 Mill Finish Optional Finish (extra Charge): <input type="checkbox"/> 02 Satin Silver <input type="checkbox"/> 03 Black. <input type="checkbox"/> 28 Custom Color / Setup Charge	<input type="checkbox"/> XG-OBD - Steel Opposed Blade Damper <input type="checkbox"/> XG-OBDA - Aluminum Opposed Blade Damper <input type="checkbox"/> XG-L9 - Equalizing Grid. <input type="checkbox"/> XG-PF - Plaster Frame. <input type="checkbox"/> XG-TBPF - T-Bar Plaster Frame <input type="checkbox"/> XG-TR - Transition Square / Rectangular to Round up to 22x22 <input type="checkbox"/> XG-TR - Deep Transition Used with Dampers <input type="checkbox"/> XG-LIPF - Lay-in Plaster Frame	<input type="checkbox"/> IS - Insect Screen. X <input type="checkbox"/> FGBP - Factory Installed R6 Insulation On 24x24 Panels Only. <input type="checkbox"/> NSH - No Screw Holes	<ul style="list-style-type: none"> ● Frame is extruded aluminum, core is aluminum eggcrate. ● Odd / Fractional Sizes. ● Oversized units made in multiple sections, each with full flanges. ● Mullion strips provided for joining units in field. ● XG-CC5-9 Max Neck Size 20x20 Max Panel Size 24x24

MODEL XG-CC5-1 CM

Side Wall / Ceiling Return Grilles and Registers Extruded Aluminum - 1/2" x 1/2" x 1/2" Core

Models: XG-CC5-1 CM Side Wall / Ceiling Return Grille - Surface Mount

Model: XG-CC5-1 CM (Return Grille - Surface Mount)

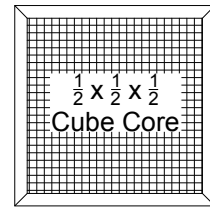
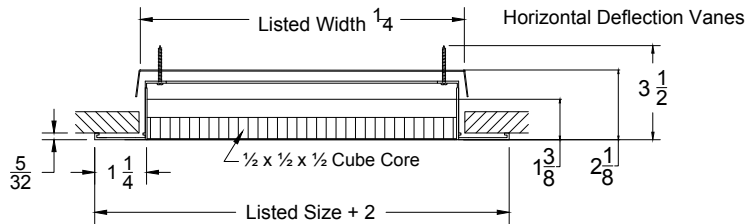

Face View

Model: XG-CC5-1 CM -XG-OBD (Return Grille - Concealed Mounting)

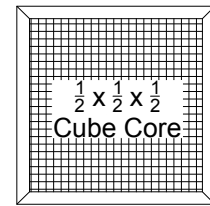
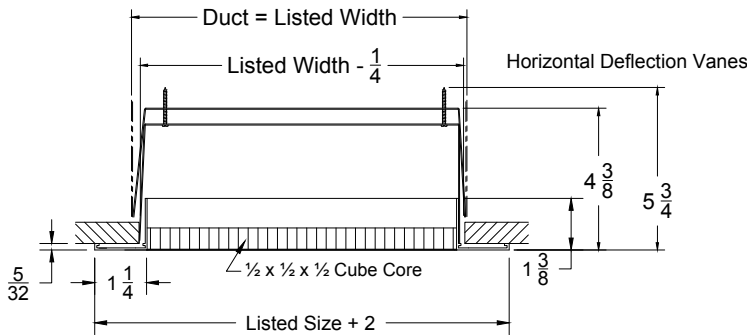

Face View

Notes: (check if provided)

1. Available Finishes	2. Available Accessories	3. Available Options	4. Construction Details
Standard Finish: <input type="checkbox"/> 01 White. Optional Finish (no extra charge): <input type="checkbox"/> 24 Mill Finish. Optional Finish (extra charge): <input type="checkbox"/> 02 Satin Silver <input type="checkbox"/> 03 Black <input type="checkbox"/> 28 Custom Color / Setup Charge	<input type="checkbox"/> XG-OBDA - Steel Opposed Blade Damper <input type="checkbox"/> XG-OBDA - Aluminum Opposed Blade Damper <input type="checkbox"/> XG-L9 - Equalizing Grid.	<input type="checkbox"/> IS - Insect Screen.	

SERIES XG-CC PERFORMANCE DATA
MODELS XG-CC5

Size	Duct Area ft²	Nk Vel	200	300	400	500	600	700	800	900	1000
		Ps	-.006	-.013	-.024	-.037	-.054	-.073	-.095	-.120	-.149
06x06	.25	CFM	46	69	92	115	138	161	184	207	230
		NC	-	-	-	-	-	14	18	22	26
08x06	.33	CFM	61	92	122	152	183	213	243	274	304
		NC	-	-	-	-	-	15	19	23	27
10x06	.42	CFM	77	115	154	192	230	268	307	345	383
		NC	-	-	-	-	11	16	20	24	28
08x08	.44	CFM	83	125	166	204	249	291	332	374	415
		NC	-	-	-	-	11	16	21	25	28
12x06	.50	CFM	92	139	185	232	279	325	372	418	465
		NC	-	-	-	-	12	17	21	25	29
16x06 12x08	.67	CFM	126	189	253	317	378	442	506	570	630
		NC	-	-	-	-	13	18	22	26	30
10x10	.69	CFM	131	196	261	327	392	457	522	588	653
		NC	-	-	-	-	13	18	22	26	30
12x10 20x06	.83	CFM	157	235	313	391	469	547	625	703	781
		NC	-	-	-	-	13	18	23	26	30
24x06 12x12	1.00	CFM	191	287	382	478	573	669	764	860	955
		NC	-	-	-	-	14	19	24	28	31
14x12	1.16	CFM	222	333	444	554	665	776	887	998	1108
		NC	-	-	-	-	15	20	24	28	31
18x10 30x06	1.25	CFM	239	359	478	597	717	836	955	1075	1194
		NC	-	-	-	-	15	20	25	29	32
14x14	1.36	CFM	260	390	520	650	780	910	1040	1169	1299
		NC	-	-	-	-	15	20	25	29	32
18x12 36x06	1.50	CFM	287	430	573	717	860	1003	1146	1290	1433
		NC	-	-	-	-	16	21	25	29	33
24x10 30x08	1.67	CFM	319	479	638	798	957	1117	1276	1436	1595
		NC	-	-	-	-	16	21	25	29	33
18x14 42x06	1.75	CFM	335	502	669	836	1003	1170	1337	1505	1672
		NC	-	-	-	-	16	21	26	30	33
18x16 24x12	2.00	CFM	382	573	764	955	1146	1337	1528	1719	1910
		NC	-	-	-	11	17	22	26	30	33
18x18	2.25	CFM	430	645	860	1075	1290	1505	1719	1934	2149
		NC	-	-	-	11	17	22	26	30	34
30x12	2.50	CFM	478	717	955	1194	1433	1672	1910	2149	2388
		NC	-	-	-	11	17	23	27	31	34
20x20	2.78	CFM	531	797	1062	1328	1593	1859	2124	2390	2655
		NC	-	-	-	12	18	23	27	31	35

CONTINUED

SERIES XG-CC PERFORMANCE DATA
MODELS XG-CC5

Size	Duct Area ft ²	Nk Vel	200	300	400	500	600	700	800	900	1000
		Ps	-0.006	-0.013	-0.024	-0.037	-0.054	-0.073	-0.095	-0.120	-0.149
24x18 36x12	3.00	CFM	573	860	1146	1433	1719	2006	2292	2579	2865
		NC	-	-	-	12	18	23	28	32	35
22x22	3.36	CFM	642	963	1284	1605	1926	2247	2568	2888	3209
		NC	-	-	-	12	18	23	28	32	35
36x14 42x12	3.50	CFM	669	1003	1337	1672	2006	2340	2674	3009	3343
		NC	-	-	-	13	19	24	28	32	36

PERFORMANCE NOTES FOR SERIES XG-CC

All data is tested in accordance with ANSI/ASHRAE 70-2006.

DEFINITION OF UNITS

CFM Cubic Feet per Minute (air)

Velocity Velocity of air stream in Feet Per Minute

Ps Negative Static pressure (inches of water column)

NC Noise criterion, sound pressure level NC ratings are based on sound power level (lw)

RE: 10⁻¹² watts minus a 10dB room attenuation in all octave bands

**SERIES XG-CC PERFORMANCE DATA
MODELS XG-CC5**

Size	Duct Area ft ²	Nk Vel	200	300	400	500	600	700	800	900	1000
		Ps	-0.06	-0.13	-0.24	-0.37	-0.54	-0.73	-0.95	-1.20	-1.49
24x22	3.67	CFM	705	1057	1410	1762	2114	2467	2819	3171	3524
		NC	-	-	-	13	19	24	28	32	36
30x18	3.75	CFM	720	1080	1440	1800	2160	2520	2880	3240	3600
		NC	-	-	-	13	19	24	28	32	36
48x12 24x24	4.00	CFM	768	1152	1536	1920	2304	2688	3072	3456	3840
		NC	-	-	-	13	19	24	29	33	36
30x20	4.17	CFM	800	1200	1600	2000	2400	2800	3200	3600	XG-4000
		NC	-	-	-	13	19	24	29	33	36
36x18	4.50	CFM	864	1296	1728	2160	2592	3024	3456	3888	4320
		NC	-	-	-	14	20	25	29	33	37
36x20 30x24	5.00	CFM	960	1440	1920	2400	2880	3360	3840	4320	4800
		NC	-	-	-	14	20	25	30	33	37
42x18	5.25	CFM	1008	1512	2016	2520	3024	3528	4032	4536	5040
		NC	-	-	-	14	20	25	30	34	37
28x28	5.44	CFM	1045	1567	2089	2612	3134	3656	4178	4701	5223
		NC	-	-	-	14	20	25	30	34	37
36x22	5.50	CFM	1056	1584	2112	2640	3168	3696	4224	4752	5280
		NC	-	-	-	14	20	25	30	34	37
48x18 36x24	6.00	CFM	1152	1728	2304	2880	3456	4032	4608	5184	5760
		NC	-	-	-	15	21	26	30	34	38
48x24 36x32	8.00	CFM	1536	2304	3072	3840	4608	5376	6144	6912	7680
		NC	-	-	-	16	22	27	31	35	39
48x30 42x34	10.00	CFM	1920	2880	3840	4800	5760	6720	7680	8640	9600
		NC	-	-	-	16	23	28	32	36	39
38x38	10.03	CFM	1926	2889	3852	4815	5778	6741	7704	8666	9629
		NC	-	-	-	16	23	28	32	36	39
42x36	10.50	CFM	2016	3024	4032	5040	6048	7056	8064	9072	10080
		NC	-	-	11	17	23	28	32	36	40
46x34	10.86	CFM	2086	3128	4171	5213	6256	7298	8341	9384	10426
		NC	-	-	11	17	23	28	32	36	40
42x38	11.08	CFM	2128	3192	4255	5319	6383	7446	8510	9574	10637
		NC	-	-	11	17	23	28	32	36	40
40x40	11.11	CFM	2134	3200	4267	5333	6400	7466	8533	9600	10666
		NC	-	-	11	17	23	28	32	36	40
48x36	12.00	CFM	2304	3456	4608	5760	6912	8064	9216	10368	11520
		NC	-	-	11	17	23	28	33	37	40

CONTINUED

SERIES XG-CC PERFORMANCE DATA
MODELS XG-CC5

Size	Duct Area ft ²	Nk Vel	200	300	400	500	600	700	800	900	1000
		Ps	-0.06	-0.13	-0.24	-0.37	-0.54	-0.73	-0.95	-1.20	-1.49
42x42	12.25	CFM	2352	3528	4704	5880	7056	8232	9408	10584	11760
		NC	-	-	11	17	23	28	33	37	40
44x44	13.44	CFM	2581	3871	5161	6452	7742	9032	10322	11613	12903
		NC	-	-	12	18	24	29	33	37	41
46x46	14.69	CFM	2821	4231	5641	7052	8462	9872	11282	12693	14103
		NC	-	-	12	18	24	29	33	37	41
48x48	16.00	CFM	3072	4608	6144	7680	9216	10752	12288	13824	15360
		NC	-	-	12	18	24	29	34	38	41

PERFORMANCE NOTES FOR SERIES XG-CC

All data is tested in accordance with ANSI/ASHRAE 70-2006.

DEFINITION OF UNITS

CFM Cubic Feet per Minute (air)

Velocity Velocity of air stream in Feet Per Minute

Ps Negative Static pressure (inches of water column)

NC Noise criterion, sound pressure level NC ratings are based on sound power level (lw)

RE: 10⁻¹² watts minus a 10dB room attenuation in all octave bands

MODEL XG-RP

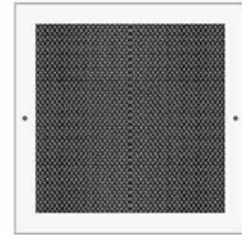

Air Inlets shall be model XG-RP manufactured by GREENHECK. Units shall be perforated face, return or exhaust grilles constructed of aluminum.

Perforate face shall have 3/16" diameter holes on 1/4" centers and shall have a 51% free area. The units shall be the size and quantity as outlined in the plans and specifications.

Border shall be 1 1/4". Units shall be designed for surface mounting applications and be provided with counter sunk screw holes on the face of the device.

Damper Accessories (Optional)

Optional opposed blade damper shall be constructed of steel (Model XG-OBD) or aluminum (Model XG-OBDA). Damper must be operable from the face of the diffuser.

Performance Specification

The manufacturer shall provide published performance data. Data shall be tested in accordance to ANSI/ASHRAE Standard 70- 2006.

Model: XG-RP-1 (Perforated Grille - Surface Mount)

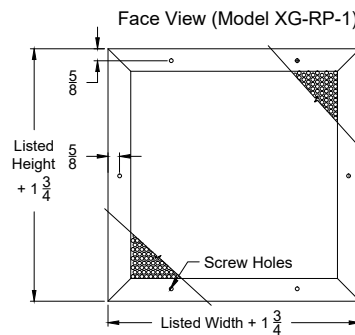
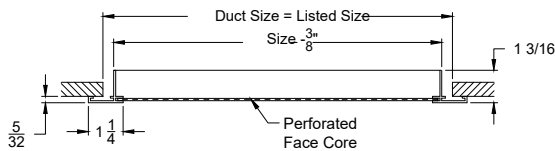

Model: XG-RP-6 (Perforated Grille - Lay In T-Bar Mount)

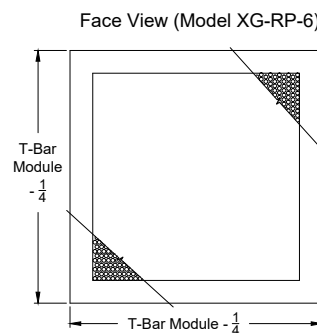
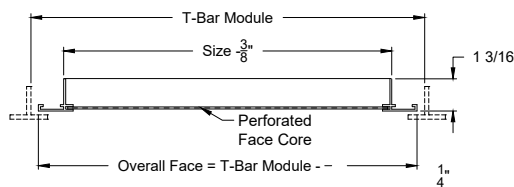

Damper Options

XG-OBD: Steel Opposed Blade Damper

XG-OBDA: Aluminum Opposed Blade Damper

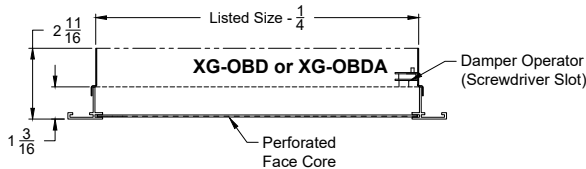

RP - 6 Standard Listed Sizes For Exposed T-Bar Lay-In Grid Application						
12 x 12	24 x 12	24 x 24	36 x 24	48 x 24	36 x 36	48 x 48
Overall Face Dimensions						
11 3/4 x 11 3/4	23 3/4 x 23 3/4	23 3/4 x 23 3/4	35 3/4 x 23 3/4	47 3/4 x 23 3/4	35 3/4 x 35 3/4	47 3/4 x 47 3/4

XG-RP MODEL NUMBER SPECIFICATION**SIDEWALL RETURN GRILLE — PERFORATED FACE — SURFACE MOUNT**

Model		Neck										Available Finishes		
XG-RP-1	Aluminum		6	8	10	12	14	16	18	20	22	24	Standard	
XG-SRP-1	Steel	4	X	X	X	X	X	X	X	X	X	X	01	White
		5	X	X	X	X	X	X	X	X	X	X	Optional	
		6	X	X	X	X	X	X	X	X	X	X	02	Satin Silver
		8	X	X	X	X	X	X	X	X	X	X	03	Black
		10	X	X	X	X	X	X	X	X	X	X	24	Mill (Aluminum Construction Only)
		12	X	X	X	X	X	X	X	X	X	X	28	Custom Color
		14	X	X	X	X	X	X	X	X	X	X		
		16	X	X	X	X	X	X	X	X	X	X		
		18	X	X	X	X	X	X	X	X	X	X		
		20	X	X	X	X	X	X	X	X	X	X		
		22	X	X	X	X	X	X	X	X	X	X		
		24	X	X	X	X	X	X	X	X	X	X		
		26	X	X	X	X	X	X	X	X	X	X		
		28	X	X	X	X	X	X	X	X	X	X		
		30	X	X	X	X	X	X	X	X	X	X		
		32	X	X	X	X	X	X	X	X	X	X		
		34	X	X	X	X	X	X	X	X	X	X		
		36	X	X	X	X	X	X	X	X	X	X		
		38	X	X	X	X	X	X	X	X	X	X		
		40	X	X	X	X	X	X	X	X	X	X		
		42	X	X	X	X	X	X	X	X	X	X		
		44	X	X	X	X	X	X	X	X	X	X		
		46	X	X	X	X	X	X	X	X	X	X		
		48	X	X	X	X	X	X	X	X	X	X		

Available Accessories	
XG-OBDA	Aluminum Opposed Blade Damper
XG-OB	Steel Opposed Blade Damper
XG-L9	Equalizing Grid
XG-PF	Plaster Frame
XG-LIPF	Lay-in Plaster Frame
IS	Insect Screen
XG-TR	Square to Round Transition
XG-TR Deep	Deep Square to Round Transition

Available Options	
NSH	No Screw Holes
CM	Concealed Mounting

XG-RP MODEL NUMBER SPECIFICATION
SIDEWALL RETURN GRILLE — PERFORATED FACE — SURFACE MOUNT

Model		Neck												Available Finishes		
XG-RP-1	Aluminum		26	28	30	32	34	36	38	40	42	44	46	48	Standard	
XG-SRP-1	Steel	4	X	X	X	X	X	X	X	X	X	X	X	X	01	White
		5	X	X	X	X	X	X	X	X	X	X	X	X	Optional	
		6	X	X	X	X	X	X	X	X	X	X	X	X	02	Satin Silver
		8	X	X	X	X	X	X	X	X	X	X	X	X	03	Black
		10	X	X	X	X	X	X	X	X	X	X	X	X	24	Mill (Aluminum Construction Only)
		12	X	X	X	X	X	X	X	X	X	X	X	X	28	Custom Color
		14	X	X	X	X	X	X	X	X	X	X	X	X		
		16	X	X	X	X	X	X	X	X	X	X	X	X		
		18	X	X	X	X	X	X	X	X	X	X	X	X		
		20	X	X	X	X	X	X	X	X	X	X	X	X		
		22	X	X	X	X	X	X	X	X	X	X	X	X		
		24	X	X	X	X	X	X	X	X	X	X	X	X		
		26	X	X	X	X	X	X	X	X	X	X	X	X		
		28	X	X	X	X	X	X	X	X	X	X	X	X		
		30	X	X	X	X	X	X	X	X	X	X	X	X		
		32	X	X	X	X	X	X	X	X	X	X	X	X		
		34	X	X	X	X	X	X	X	X	X	X	X	X		
		36	X	X	X	X	X	X	X	X	X	X	X	X		
		38	X	X	X	X	X	X	X	X	X	X	X	X		
		40	X	X	X	X	X	X	X	X	X	X	X	X		
		42	X	X	X	X	X	X	X	X	X	X	X	X		
		44	X	X	X	X	X	X	X	X	X	X	X	X		
		46	X	X	X	X	X	X	X	X	X	X	X	X		
		48	X	X	X	X	X	X	X	X	X	X	X	X		

Available Accessories	
XG-OBDA	Steel Opposed Blade Damper
XG-OBDA	Aluminum Opposed Blade Damper
XG-L9	Equalizing Grid
XG-PF	Plaster Frame
XG-LIPF	Lay-in Plaster Frame
IS	Insect Screen
XG-TR	Square to Round Transition
XG-TR Deep	Deep Square to Round Transition

Available Options	
NSH	No Screw Holes
CM	Concealed Mounting

XG-RP MODEL NUMBER SPECIFICATION
RETURN GRILLE – PERFORATED FACE – LAY-IN

Model		Neck										Module
XG-RP-6	Aluminum	6	8	10	12	14	16	18	20	22	24	
XG-SRP-6	Steel	4	X	X								12 x 12
		6	X	X								
		8	X	X								
		10			X							
		4	X	X	X	X	X	X	X			24 x 12
		6	X	X	X	X	X	X	X			
		8	X	X	X	X	X	X	X			
		10								X		
		4	X	X	X	X	X	X	X			24 x 24
		6	X	X	X	X	X	X	X			
		8	X	X	X	X	X	X	X			
		10	X	X	X	X	X	X	X			
		12	X	X	X	X	X	X	X			
		14	X	X	X	X	X	X	X			
		16	X	X	X	X	X	X	X			
		18	X	X	X	X	X	X	X			
		20	X	X	X	X	X	X	X			
		22								X		
		4	X	X	X	X	X	X	X	X	X	48 x 24
		6	X	X	X	X	X	X	X	X	X	
		8	X	X	X	X	X	X	X	X	X	
		10	X	X	X	X	X	X	X	X	X	
		12	X	X	X	X	X	X	X	X	X	
		14	X	X	X	X	X	X	X	X	X	
		16	X	X	X	X	X	X	X	X	X	
		18	X	X	X	X	X	X	X	X	X	
		20	X	X	X	X	X	X	X	X	X	

Available Finishes		Available Accessories	
Standard		XG-OBDA	Steel Opposed Blade Damper
01	White	XG-OBDA	Aluminum Opposed Blade Damper
Optional		XG-L9	Equalizing Grid
02	Satin Silver	XG-TBPF	T-bar Plaster Frame
03	Black	IS	Insect Screen
24	Mill (Aluminum Construction Only)	XG-TR	Square to Round Transition
28	Custom Color	XG-TR Deep	Deep Square to Round Transition

XG-RP MODEL NUMBER SPECIFICATION
RETURN GRILLE – PERFORATED FACE – LAY-IN

Model		Neck												Module
		26	28	30	32	34	36	38	40	42	44	46		
XG-RP-6	Aluminum													
XG-SRP-6	Steel	4	X	X	X	X	X	X	X	X	X	X	X	48 x 24
		6	X	X	X	X	X	X	X	X	X	X		
		8	X	X	X	X	X	X	X	X	X	X		
		10	X	X	X	X	X	X	X	X	X	X		
		12	X	X	X	X	X	X	X	X	X	X		
		14	X	X	X	X	X	X	X	X	X	X		
		16	X	X	X	X	X	X	X	X	X	X		
		18	X	X	X	X	X	X	X	X	X	X		
		20	X	X	X	X	X	X	X	X	X	X		
		22										X		

Available Finishes		Available Accessories	
Standard		XG-OB	Steel Opposed Blade Damper
01	White	XG-OBDA	Aluminum Opposed Blade Damper
Optional		XG-L9	Equalizing Grid
02	Satin Silver	XG-TBPF	T-bar Plaster Frame
03	Black	IS	Insect Screen
24	Mill (Aluminum Construction Only)	XG-TR	Square to Round Transition
28	Custom Color	XG-TR Deep	Deep Square to Round Transition

XG-RP MODEL NUMBER SPECIFICATION
RETURN GRILLE – PERFORATED FACE – LAY-IN

Model		Neck											Module
XG-RP-6	Aluminum		6	8	10	12	14	16	18	20	22	24	
XG-SRP-6	Steel	4	X	X	X	X	X	X	X	X	X	X	48 x 48
		6	X	X	X	X	X	X	X	X	X	X	
		8	X	X	X	X	X	X	X	X	X	X	
		10	X	X	X	X	X	X	X	X	X	X	
		12	X	X	X	X	X	X	X	X	X	X	
		14	X	X	X	X	X	X	X	X	X	X	
		16	X	X	X	X	X	X	X	X	X	X	
		18	X	X	X	X	X	X	X	X	X	X	
		20	X	X	X	X	X	X	X	X	X	X	
		22	X	X	X	X	X	X	X	X	X	X	
		24	X	X	X	X	X	X	X	X	X	X	
		26	X	X	X	X	X	X	X	X	X	X	
		28	X	X	X	X	X	X	X	X	X	X	
		30	X	X	X	X	X	X	X	X	X	X	
		32	X	X	X	X	X	X	X	X	X	X	
		34	X	X	X	X	X	X	X	X	X	X	
		36	X	X	X	X	X	X	X	X	X	X	
		38	X	X	X	X	X	X	X	X	X	X	
		40	X	X	X	X	X	X	X	X	X	X	
		42	X	X	X	X	X	X	X	X	X	X	
		44	X	X	X	X	X	X	X	X	X	X	

Available Finishes		Available Accessories	
Standard		XG-OB	Steel Opposed Blade Damper
01	White	XG-OBDA	Aluminum Opposed Blade Damper
Optional		XG-L9	Equalizing Grid
02	Satin Silver	XG-TBPF	T-bar Plaster Frame
03	Black	IS	Insect Screen
24	Mill (Aluminum Construction Only)	XG-TR	Square to Round Transition
28	Custom Color	XG-TR Deep	Deep Square to Round Transition

XG-RP MODEL NUMBER SPECIFICATION
RETURN GRILLE – PERFORATED FACE – LAY-IN

Model		Neck												Module
XG-RP-6	Aluminum	26	28	30	32	34	36	38	40	42	44	46		
XG-SRP-6	Steel	4	X	X	X	X	X	X	X	X	X	X	48 x 48	
		6	X	X	X	X	X	X	X	X	X	X		
		8	X	X	X	X	X	X	X	X	X	X		
		10	X	X	X	X	X	X	X	X	X	X		
		12	X	X	X	X	X	X	X	X	X	X		
		14	X	X	X	X	X	X	X	X	X	X		
		16	X	X	X	X	X	X	X	X	X	X		
		18	X	X	X	X	X	X	X	X	X	X		
		20	X	X	X	X	X	X	X	X	X	X		
		22	X	X	X	X	X	X	X	X	X	X		
		24	X	X	X	X	X	X	X	X	X	X		
		26	X	X	X	X	X	X	X	X	X	X		
		28	X	X	X	X	X	X	X	X	X	X		
		30	X	X	X	X	X	X	X	X	X	X		
		32	X	X	X	X	X	X	X	X	X	X		
		34	X	X	X	X	X	X	X	X	X	X		
		36	X	X	X	X	X	X	X	X	X	X		
		38	X	X	X	X	X	X	X	X	X	X		
		40	X	X	X	X	X	X	X	X	X	X		
		42	X	X	X	X	X	X	X	X	X	X		
		44	X	X	X	X	X	X	X	X	X	X		
		46										X		

Available Finishes		Available Accessories	
Standard		XG-OB	Steel Opposed Blade Damper
01	White	XG-OBDA	Aluminum Opposed Blade Damper
Optional		XG-L9	Equalizing Grid
02	Satin Silver	XG-TBPF	T-bar Plaster Frame
03	Black	IS	Insect Screen
24	Mill (Aluminum Construction Only)	XG-TR	Square to Round Transition
28	Custom Color	XG-TR Deep	Deep Square to Round Transition

SERIES XG-RP PERFORMANCE DATA
MODELS XG-RP, XG-SRP

Size	Duct Area ft ²	Nk Vel	300	400	500	600	700	800	900	1000	1100
		Ps	-.023	-.041	-.064	-.092	-.126	-.165	-.209	-.259	-.314
06x06	.25	CFM	58	77	96	116	135	154	173	192	212
		NC	-	-	13	16	18	21	22	24	25
08x06	.33	CFM	81	107	134	161	187	214	241	267	294
		NC	-	11	15	18	20	22	24	24	27
10x06	.42	CFM	103	137	171	205	239	273	307	341	376
		NC	-	12	16	19	21	23	25	27	28
08x08	.44	CFM	112	149	186	223	260	297	334	371	409
		NC	-	13	16	19	21	24	25	27	28
12x06	.50	CFM	124	165	206	248	289	330	371	412	454
		NC	-	13	17	19	22	24	26	27	29
16x06 12x08	.67	CFM	172	229	286	343	400	457	514	571	629
		NC	-	15	18	21	23	26	27	29	30
10x10	.69	CFM	178	237	296	355	414	473	532	591	651
		NC	-	15	18	21	23	25	27	29	30
18x06	.75	CFM	190	253	316	379	442	505	568	631	695
		NC	11	15	18	21	24	26	28	29	31
24x06 12x12	1.00	CFM	265	353	441	529	617	705	793	881	970
		NC	12	16	20	23	25	27	29	31	32
30x06 18x10	1.25	CFM	334	445	556	667	778	889	1000	1111	1223
		NC	13	17	21	24	26	28	30	32	33
36x06 18x12	1.50	CFM	406	541	676	811	946	1081	1216	1351	1487
		NC	14	18	22	25	27	29	31	32	34
42x06 18x14	1.75	CFM	478	637	796	955	1114	1273	1432	1591	1751
		NC	15	19	22	25	28	30	32	33	35
24x12 18x16	2.00	CFM	547	729	911	1093	1275	1457	1639	1821	2004
		NC	15	20	23	26	28	30	32	34	35
30x12	2.50	CFM	688	917	1146	1375	1604	1833	2062	2291	2521
		NC	16	21	24	27	29	31	33	35	36
36x12	3.00	CFM	826	1101	1376	1651	1926	2201	2476	2751	3027
		NC	17	21	25	28	30	32	34	35	37
42x12 36x14	3.50	CFM	967	1289	1611	1933	2255	2577	2899	3221	3544
		NC	17	22	25	28	31	33	34	36	38
48x12 24x24	4.00	CFM	1126	1501	1876	2251	2626	3001	3376	3751	4127
		NC	18	23	26	29	31	34	35	37	38
36x20 30x24	5.00	CFM	1414	1885	2356	2827	3298	3769	4240	4711	5183
		NC	19	24	27	30	32	34	36	38	39

SERIES XG-RP PERFORMANCE DATA
MODELS XG-RP, XG-SRP

Size	Duct Area ft ²	Nk Vel	300	400	500	600	700	800	900	1000	1100
		Ps	-.023	-.041	-.064	-.092	-.126	-.165	-.209	-.259	-.314
48x18 36x24	6.00	CFM	1699	2265	2831	3397	3963	4529	5095	5661	6228
		NC	20	24	28	31	33	35	37	39	40
48x24 36x32	8.00	CFM	2290	3053	3816	4579	5342	6105	6868	7631	8395
		NC	21	26	39	32	34	36	38	40	41
48x36	12.00	CFM	3472	4629	5786	6943	8100	9257	10414	11571	12729
		NC	23	28	31	34	36	38	40	42	43
48x48	16.00	CFM	4653	6204	7755	9306	10857	12408	13959	15510	17061
		NC	24	29	32	35	37	40	41	43	44

PERFORMANCE NOTES FOR SERIES XG-RP

All data is tested in accordance with ANSI/ASHRAE 70-2006.

DEFINITION OF UNITS

CFM Cubic Feet per Minute (air)

Nk Vel Neck Velocity of air stream in Feet Per Minute

Ps Negative Static pressure (inches of water column)

NC Noise criterion, sound pressure level. NC ratings are based on sound power level (Lw) re: 10⁻¹² watts minus a 10dB room attenuation in all octave bands

SPIRAL DUCT GRILLES

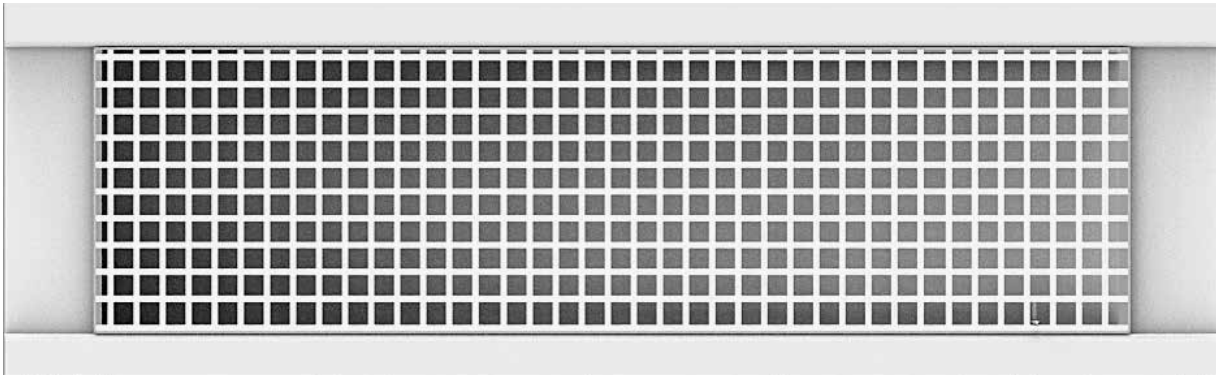

Greenheck spiral duct grilles are designed specifically for mounting on a round or spiral duct eliminating the need for a contractor fabricated register tab.

Aluminum/Steel Spiral Duct Mounted Grille

The XG-4004P series of spiral duct grilles offers a double deflection and perforated face supply as well as a perforated face return. The XG-4004P series is designed so that the flange meets flush to the duct regardless of the duct diameter.

- XG-4004P – Aluminum – Double deflection supply
- XG-4004SP – Steel – Double deflection supply

PAGE 101

MODEL XG-4004P

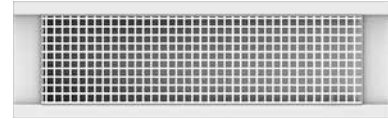

Supply - Double Deflection Spiral Pipe Grilles XG-4004P-1 – Surface Mount

Air Outlets shall be model XG-4004P (aluminum construction) or XG 4004SP (galvanized steel construction) direct spiral duct-mounted supply grilles manufactured by GREENHECK. Units shall be double deflection supply grilles with a front and rear sets of deflection blades. The units shall be the size and quantity as outlined in the plans and specifications.

Units shall include an air extractor (air scoop) mounted on the back of the grille. Extractor shall be face operated using an extractor adjustment rod.

Grilles shall conform tightly to the duct radius and include a foam gasket around sides and end caps of the unit. Aerodynamically shaped deflector blades shall be on 0.666" centers. Deflector blades shall be individually adjustable. Units shall be provided with counter sunk screw holes on the face for surface mounting. Blades shall pivot in polymer friction mounting retainers. Retainers shall hold the deflector blade position throughout the specified operating range of the device. Metal friction wires are not acceptable.

Performance Specification:

The manufacturer shall provide published performance data. Data shall be tested in accordance to ANSI/ASHRAE Standard 70- 2006

Paint Specification:

Process shall be anodic electrodeposition using an anodic acrylic paint. Units shall undergo pre-treatment including a pressurized spray stage using an alkaline cleaner and a de-ionized water rinse.

MODEL XG-4004P

Industrial Spiral Pipe Supply Grille Galvanized Steel and Aluminum Construction - Double Deflection

- Models: **XG-4004SP-1** Galvanized Steel Double Deflection Grille - Vertical Front Blades
 XG-4004P-1 Aluminum - Double Deflection Grille - Vertical Front Blades

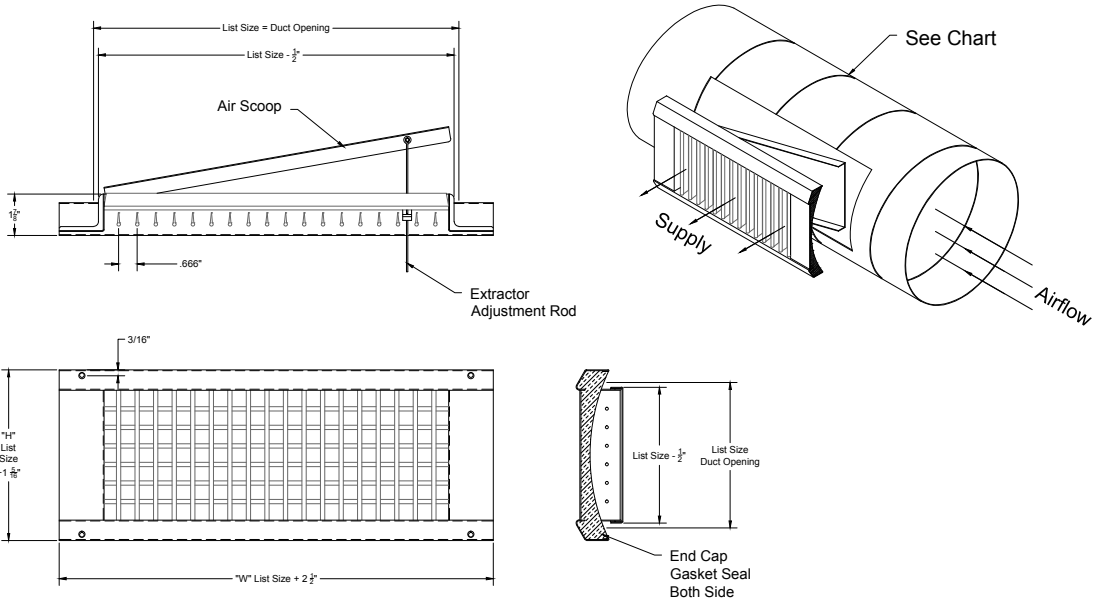

Available in listed sizes only

HEIGHT	WIDTH														
	10"	12"	14"	16"	18"	20"	24"	30"	36"	38"	40"	42"	44"	46"	48"
	MINIMUM / MAXIMUM DUCT DIAMETER														
3"	6/24	6/24	6/24	6/24	6/24	6/24	6/24	6/24	6/24	6/24	6/24	6/24	6/24	6/24	6/24
4"	8/24	8/24	8/24	8/24	8/24	8/24	8/24	8/24	8/24	8/24	8/24	8/24	8/24	8/24	8/24
6"	12/24	12/24	12/24	12/24	12/24	12/24	12/24	12/24	12/24	12/24	12/24	12/24	12/24	12/24	12/24
8"	-	-	20/36	20/36	20/36	20/36	20/36	20/36	20/36	20/36	20/36	20/36	20/36	20/36	20/36
10"	-	-	-	30/48	30/48	30/48	30/48	30/48	30/48	30/48	30/48	30/48	30/48	30/48	30/48
12"	-	-	-	42/48	42/48	42/48	42/48	42/48	42/48	42/48	42/48	42/48	42/48	42/48	42/48

Notes: (check if provided)

1. Available Finishes	2. Available Accessories	3. Available Options	4. Construction Details
Standard Finish on XG-4004SP: <input type="checkbox"/> 24 Mill Finish only (Galvanized Steel) Standard Finish on XG-4004P: <input type="checkbox"/> 01 White		<input type="checkbox"/> Air Scoop <input type="checkbox"/> No Air Scoop	<ul style="list-style-type: none"> • Air Scoop includes wire handle for operation. • Ends are supplied with foam gasket to seal around duct. • Units are surface mount and provided with screw to mount into duct.

MODEL XG-4004PCF

Supply - Double Deflection Spiral Pipe Registers XG-4004PCF-1 – Surface Mount

Air Inlets shall be model XG-4004PCF.

Model XG-4004PCF shall be manufactured by GREENHECK. Units shall be direct spiral duct-mounted aluminum supply grilles manufactured by GREENHECK. Units shall be double deflection supply grilles with two sets of adjustable deflection blades. The units shall be the size and quantity as outline in the plans and specifications. Grilles shall include a curved flange which will equal the curvature of the ductwork to maintain a flush installation. Grilles shall conform tightly to the duct radius and include a foam gasket around sides and end caps of the unit.

Aerodynamically shaped deflector blades shall be on 0.666" centers. Deflector blades shall be individually adjustable. Units shall be provided with counter sunk screw holes on the face for surface mounting. Blades shall pivot in friction mounting retainers. Retainers shall hold the deflector blade position throughout the specified operating range of the device. Metal friction wires are not acceptable.

Air Extractor Accessory (Optional):

Units shall include an optional air extractor mounted on the back of the register. Extractor shall be face operated using an extractor adjustment rod.

Performance Specification:

The manufacturer shall provide published performance data. Data shall be tested in accordance to ANSI/ASHRAE Standard 70- 2006.

MODEL XG-4004PCF

Industrial Spiral Duct Grille / Double Deflection / Curve Flange Aluminum Construction

Models: XG-4004PCF-1 Aluminum - Double Deflection Grille - Curved Flange - Vertical Front Blades

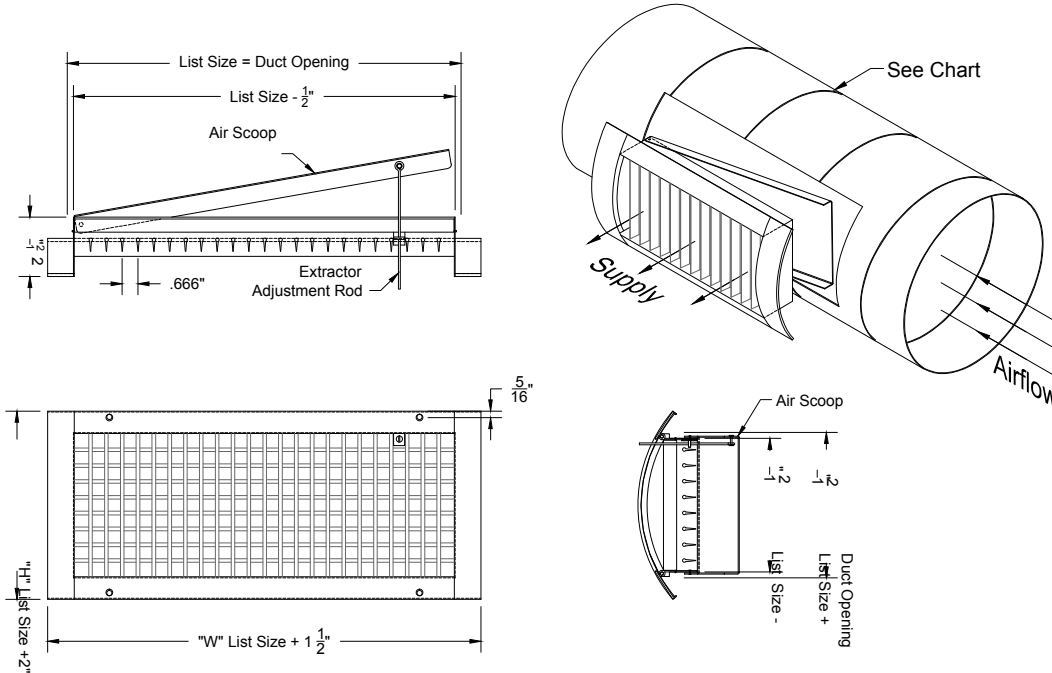

Available in listed sizes only

Height	Width													
	10"	12"	14"	16"	18"	20"	24"	30"	36"	40"	42"	44"	46"	48"
	MINIMUM / MAXIMUM DUCT DIAMETER													
3"	6 / 16	6 / 16	6 / 16	6 / 16	6 / 16	6 / 16	6 / 16	6 / 16	6 / 16	6 / 16	6 / 16	6 / 16	6 / 16	6 / 16
4"	8 / 16	8 / 16	8 / 16	8 / 16	8 / 16	8 / 16	8 / 16	8 / 16	8 / 16	8 / 16	8 / 16	8 / 16	8 / 16	8 / 16
6"	10 / 28	10 / 28	10 / 28	10 / 28	10 / 28	10 / 28	10 / 28	10 / 28	10 / 28	10 / 28	10 / 28	10 / 28	10 / 28	10 / 28
8"	14 / 30	14 / 30	14 / 30	14 / 30	14 / 30	14 / 30	14 / 30	14 / 30	14 / 30	14 / 30	14 / 30	14 / 30	14 / 30	14 / 30
10"	-	-	16 / 30	16 / 30	16 / 30	16 / 30	16 / 30	16 / 30	16 / 30	16 / 30	16 / 30	16 / 30	16 / 30	16 / 30
12"	-	-	-	-	18 / 30	18 / 30	18 / 30	18 / 30	18 / 30	18 / 30	18 / 30	18 / 30	18 / 30	18 / 30

Notes: (check if provided)

1. Available Finishes	2. Available Accessories	3. Available Options	4. Construction Details
Standard Finish: <input type="checkbox"/> 01 White Standard Finish (no extra charge): <input type="checkbox"/> 24 Mill Finish Optional Finish (extra charge): <input type="checkbox"/> 02 Satin Silver <input type="checkbox"/> 03 Black <input type="checkbox"/> 28 Custom Color / Setup Charge		<input type="checkbox"/> Air Scoop <input type="checkbox"/> No Air Scoop	<ul style="list-style-type: none"> • Ends are supplied with foam gasket to seal around duct. • Units are surface mount. Provided with screw template to mount into duct. • Air Scoop includes wire handle for operation.

SERIES XG-4004P PERFORMANCE DATA
MODELS XG-4004P, XG-4004SP

Size	Nk Vel	Pt	200	300	400	500	600	700	800	900
			.007	.015	.027	.042	.061	.083	.108	.137
10x03	Ac ft ²	CFM	29	43	58	72	87	101	116	130
	0.15	NC	-	-	-	-	14	19	23	26
	Throw		2-4-9	4-6-12	6-9-14	7-11-16	9-12-17	10-13-18	11-14-20	12-15-21
12x03	Ac ft ²	CFM	35	53	70	88	105	123	141	158
	0.18	NC	-	-	-	-	15	20	24	27
	Throw		2-4-10	4-7-13	6-10-15	8-12-17	10-13-19	11-14-20	13-15-22	13-16-23
10x04 14x03	Ac ft ²	CFM	42	63	84	104	125	146	167	188
	0.21	NC	-	-	-	-	16	20	24	28
	Throw		2-5-10	5-8-15	7-10-17	9-13-19	10-15-21	12-16-22	14-17-24	15-18-25
12x04 16x03	Ac ft ²	CFM	51	76	102	127	152	178	203	229
	0.26	NC	-	-	-	11	17	21	25	29
	Throw		2-5-11	5-9-16	8-11-19	10-14-21	11-16-23	13-17-25	15-19-26	16-20-28
18x03 14x04	Ac ft ²	CFM	54	81	108	135	162	189	216	243
	0.27	NC	-	-	-	11	17	22	26	29
	Throw		2-6-12	6-9-17	8-12-19	10-15-21	12-17-23	14-18-25	16-19-27	17-20-29
10x06 16x04 20x03	Ac ft ²	CFM	68	101	135	169	202	236	270	304
	0.34	NC	-	-	-	12	18	22	26	30
	Throw		3-6-13	6-10-18	9-13-21	11-17-24	13-18-26	15-20-28	17-21-30	18-23-32
12x06 18x04 24x03	Ac ft ²	CFM	82	123	164	205	246	287	328	369
	0.41	NC	-	-	-	13	19	23	27	31
	Throw		3-7-15	7-11-20	10-15-24	12-18-26	15-20-29	17-22-31	19-24-33	20-25-35
30x03	Ac ft ²	CFM	92	137	183	229	274	320	366	411
	0.46	NC	-	-	-	14	19	24	28	31
	Throw		3-7-15	7-12-22	10-15-25	13-19-28	15-22-30	18-23-33	20-25-35	22-26-37
14x06 20x04	Ac ft ²	CFM	97	145	193	241	290	338	386	435
	0.49	NC	-	-	-	14	19	24	28	31
	Throw		3-7-16	7-12-22	11-16-26	13-20-29	16-22-31	18-24-34	21-26-36	22-27-38
16x06 24x04	Ac ft ²	CFM	111	167	222	278	334	389	445	500
	0.56	NC	-	-	-	15	20	25	39	32
	Throw		4-8-17	8-13-24	11-17-27	14-21-31	17-24-34	20-26-36	22-27-39	24-29-41
18x06 36x03	Ac ft ²	CFM	126	188	251	314	377	440	503	566
	0.63	NC	-	-	-	15	20	25	29	31
	Throw		4-8-18	8-14-25	12-18-29	15-23-33	18-25-36	21-27-39	24-29-41	25-31-44
14x08	Ac ft ²	CFM	134	200	267	334	400	467	534	600
	0.67	NC	-	-	-	15	21	25	29	31
	Throw		4-9-19	9-14-26	12-19-30	16-23-34	19-26-37	22-28-40	25-30-42	26-32-45

CONTINUED

SERIES XG-4004P PERFORMANCE DATA
MODELS XG-4004P, XG-4004SP

Size	Nk Vel	Pt	200	300	400	500	600	700	800	900
			.007	.015	.027	.042	.061	.083	.108	.137
16x08	Ac ft ²	CFM	154	230	307	384	461	538	614	691
	0.77	NC	-	-	-	16	21	26	30	33
20x06	Throw		4-9-20	9-15-28	13-20-32	17-25-36	20-28-39	23-30-43	26-32-46	28-34-48
30x04	Ac ft ²	CFM	174	261	348	434	521	608	695	782
	0.87	NC	-	-	-	16	22	26	30	34
18x08	Throw		4-10-21	10-16-30	14-21-34	18-27-38	21-30-42	25-32-45	28-34-48	30-36-51
24x06	Ac ft ²	CFM	194	291	388	485	582	678	775	872
	0.97	NC	-	-	11	17	21	27	31	34
36x04	Throw		5-11-22	10-17-31	15-22-36	19-28-40	22-31-44	26-34-48	30-36-51	31-38-54
20x08 42x04	Ac ft ²	CFM	222	333	444	554	665	776	887	997
	1.11	NC	-	-	12	17	23	27	31	35
18x10 30x06	Throw		5-11-24	11-18-34	16-24-39	20-30-43	24-34-47	28-36-51	32-39-55	34-41-58
20x10	Ac ft ²	CFM	247	371	494	618	742	865	989	1112
	1.24	NC	-	-	12	18	23	28	32	35
24x08	Throw		5-12-25	12-19-35	17-25-41	21-32-46	25-35-50	30-38-54	33-41-58	35-43-61
48x04	Throw		5-12-25	12-19-35	17-25-41	21-32-46	25-35-50	30-38-54	33-41-58	35-43-61

PERFORMANCE NOTES FOR SERIES XG-4000P

All data is tested in accordance with ANSI/ASHRAE 70-2006.

DEFINITION OF UNITS

CFM Cubic Feet per Minute (air)

Velocity Velocity of air stream in Feet per Minute

Ps Static pressure = $P_t - P_v$ (inches of water column)

Throw Non-isothermal horizontal throw (supply air temperature 15°F colder than average room temperature); values are for 150, 100 and 50fpm velocities

NC Noise criterion, sound pressure level NC ratings are based on sound power level (Lw) re: 10^{-12} watts minus a 10dB room attenuation in all octave bands

Ac Actual Core Free Area in square feet

SERIES XG-4004P PERFORMANCE DATA
MODELS XG-4004P, XG-4004SP

Size	Nk Vel		200	300	400	500	600	700	800	900
	Pt		.007	.015	.027	.042	.061	.083	.108	.137
18x12 36x06	Ac ft ²	CFM	270	405	539	674	809	943	1078	1212
	1.35	NC	-	-	12	18	24	28	32	36
	Throw		6-12-27	12-20-37	18-26-43	22-33-48	26-37-52	31-40-56	35-43-60	37-45-64
20x12 24x10 30x08	Ac ft ²	CFM	301	451	602	752	903	1053	1203	1354
	1.51	NC	-	-	12	19	24	29	33	36
	Throw		6-13-28	13-21-39	19-28-45	23-35-50	28-39-55	33-42-60	37-45-64	39-48-68
42x06	Ac ft ²	CFM	301	451	602	752	903	1053	1203	1354
	1.51	NC	-	-	12	19	24	29	33	36
	Throw		6-13-28	13-21-39	19-28-45	23-35-50	28-39-55	33-42-60	37-45-64	39-48-68
24x12 36x08 48x06	Ac ft ²	CFM	364	546	727	909	1090	1272	1453	1635
	1.82	NC	-	-	13	19	25	30	33	37
	Throw		6-14-31	14-23-43	20-31-50	26-38-55	31-43-61	36-46-66	40-50-70	43-53-74
30x10	Ac ft ²	CFM	376	564	752	939	1127	1315	1503	1680
	1.88	NC	-	-	13	20	25	30	34	37
	Throw		6-15-31	15-23-44	21-31-50	26-39-56	31-44-62	36-47-67	41-50-71	44-53-76
42x08	Ac ft ²	CFM	416	634	831	1039	1246	1454	1661	1869
	2.08	NC	-	-	13	20	25	30	34	38
	Throw		7-15-33	15-25-46	22-33-53	27-41-59	33-46-65	38-50-70	43-53-75	46-56-79
30x12 36x10	Ac ft ²	CFM	456	685	914	1142	1371	1600	1829	2057
	2.28	NC	-	-	14	20	26	30	34	38
	Throw		7-16-34	16-26-48	23-34-56	29-43-62	34-48-68	40-52-74	45-56-79	48-59-83
48x08	Ac ft ²	CFM	476	714	952	1190	1428	1666	1904	2142
	2.38	NC	-	-	14	21	26	31	35	38
	Throw		7-16-35	16-26-49	23-35-57	29-44-63	35-49-69	41-53-75	46-57-80	49-60-85
42x10	Ac ft ²	CFM	530	795	1060	1325	1590	1855	2120	2385
	2.65	NC	-	-	14	21	26	31	35	39
	Throw		8-17-37	17-28-52	25-37-60	31-46-67	37-52-73	43-56-79	49-60-85	52-63-90
36x12	Ac ft ²	CFM	550	826	1101	1377	1652	1928	2203	2479
	2.75	NC	-	-	15	21	27	31	35	39
	Throw		8-18-38	18-28-53	25-38-61	32-47-68	38-53-75	44-57-81	50-61-86	53-65-92

CONTINUED

SERIES XG-4004P PERFORMANCE DATA
MODELS XG-4004P, XG-4004SP

Size	Nk Vel		200	300	400	500	600	700	800	900
	Pt		.007	.015	.027	.042	.061	.083	.108	.137
48x10	Ac ft ²	CFM	606	910	1214	1517	1821	2125	2429	2732
	3.03	NC	-	-	15	22	27	32	36	39
	Throw		8-19-40	19-30-55	26-40-64	33-50-72	40-55-78	46-60-85	52-64-91	55-68-96
42x12	Ac ft ²	CFM	646	968	1291	1613	1935	2257	2580	2902
	3.23	NC	-	-	15	22	27	32	36	39
	Throw		9-19-41	19-31-57	27-41-66	34-51-74	41-57-81	48-62-87	54-66-93	57-70-99
48x12	Ac ft ²	CFM	738	1107	1476	1845	2214	2583	2952	3321
	1.22	NC	-	-	16	22	38	32	36	40
	Throw		9-20-44	20-33-61	29-44-71	36-55-79	44-61-87	51-66-93	58-71-100	61-75-106

PERFORMANCE NOTES FOR SERIES XG-4004P

All data is tested in accordance with ANSI/ASHRAE 70-2006.

DEFINITION OF UNITS

CFM Cubic Feet per Minute (air)

Velocity Velocity of air stream in Feet per Minute

Ps Static pressure = $P_t - P_v$ (inches of water column)

Throw Non-isothermal horizontal throw (supply air temperature 15°F colder than average room temperature); values are for 150, 100 and 50fpm velocities

NC Noise criterion, sound pressure level NC ratings are based on sound power level (Lw) re: 10^{-12} watts minus a 10dB room attenuation in all octave bands

Ac Actual Core Free Area in square feet

MODEL XG-RL-SP

The XG-RL-SP series is designed to provide jet or diffused air patterns in ceiling, sidewall and exposed duct applications such as sports arenas and gymnasiums. In sidewall and exposed duct installations, the XG-RL-SP can be mounted vertically or horizontally. The RL-SP is ideal for vertical spot cooling or heating when mounted in the ceiling or on the bottom of exposed ductwork. They are capable of supplying straight flow primary air jet streams at 0° deflection for long throws, and a diffused pattern of primary air at 15° and 30° deflections for short throws with greater spread. The cylindrical drum enables primary air to be directed horizontally or vertically within a 60° arc. Because of its extreme flexibility the adjustable louvers provide accurate directional control of primary air.

- Available in sizes minimum 9" x 6" and maximum 70" x 15"
- Individually adjustable deflection blades and rotating cylindrical drum assembly
- Optional gang operator
- Optional dual flow blades

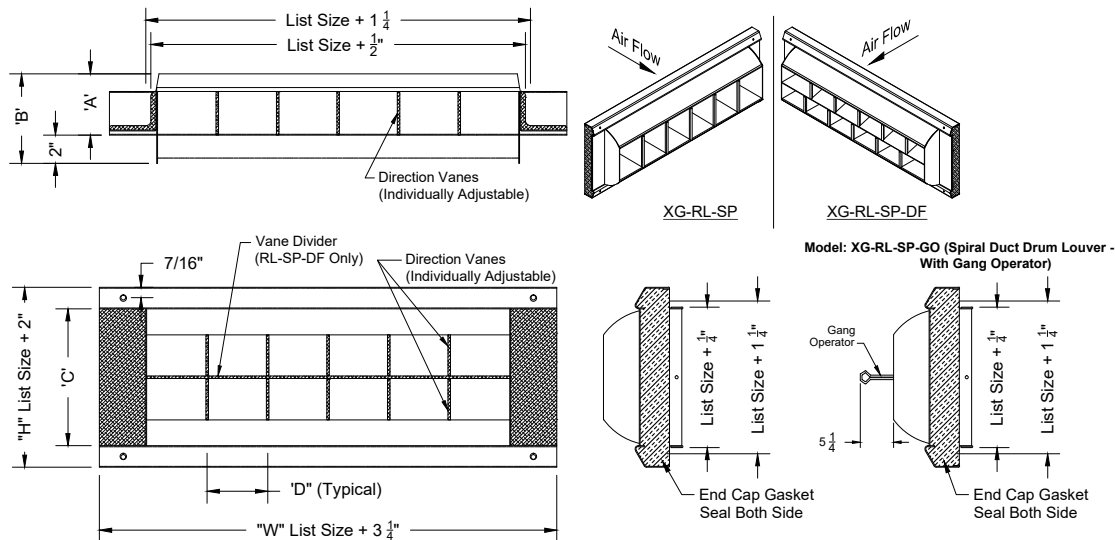

Available Listed Heights	6						10						12						15													
	9	12	18	24	30	36	48	60	20	25	30	35	40	50	60	70	20	25	30	35	40	50	60	70	15	20	25	30	40	50	60	70
Available Listed Widths	2		3		5		7		9		11		15		19		3		4		5		6		7		9		11		13	
Number of Louvers	2		3		5		7		9		11		15		19		3		4		5		6		7		9		11		13	
A	1 3/4						2 5/8						3						3 1/2													
B	4 3/8						6 1/8						6 1/8						8													
C	3 1/2						5 7/8						6 1/4						9 1/2													
D	3						5						5						5													
E	8 1/2						12 1/4						13 7/8						16 7/8													
F	7						10 13/16						12 1/2						15 1/2													

Optional Air Scoop

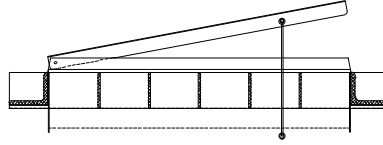

Optional XG-OBDE Damper

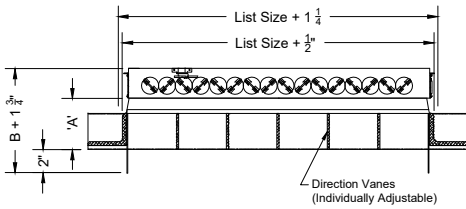

Optional XG-DA Damper

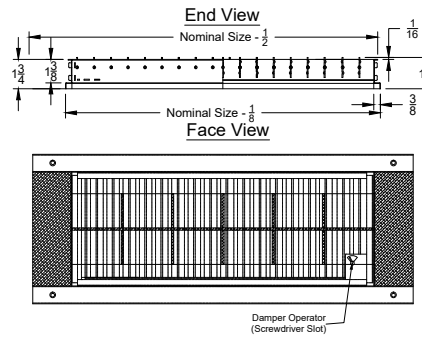
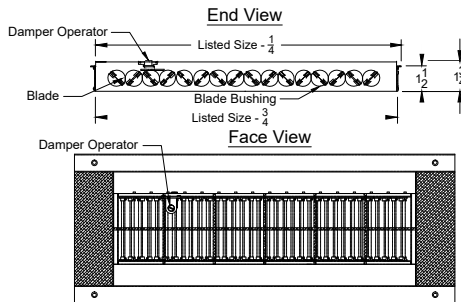
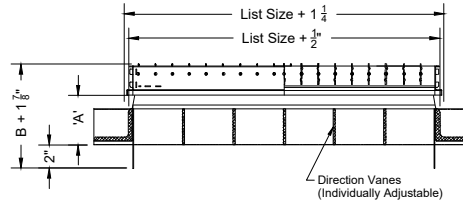

XG-RL-SP MODEL NUMBER SPECIFICATIONS
XG-RL ROTO LOUVER

Model		Neck															
XG-RL	Standard Blades		9	12	15	18	20	24	25	30	35	36	40	48	50	60	70
XG-RL-DF	Dual Flow Blades	6	X	X	X	X		X		X		X		X		X	
XG-RL-GO	Standard Blades with Gang Operator	10					X		X	X	X		X		X	X	X
		12					X		X	X	X		X		X	X	X
		15			X		X		X	X			X		X	X	X

Available Finishes		Available Accessories	
Standard		DA	Aluminum Opposed Blade Damper
04	Clear Anodized		
Optional			
01	White		
02	Satin Silver		
03	Black		
28	Custom Color		

SERIES XG-RL-SP PERFORMANCE DATA
MODEL XG-RL-SP

Size	Nk Vel	300	400	500	600	700	800	900	1000
	Pv	.006	.010	.016	.022	.031	.04	.050	.062
09x06	CFM	113	150	188	225	263	300	338	375
	Pt	.042	.075	.116	.168	.228	.298	.376	.465
	Throws	6-20	9-27	11-32	14-35	16-38	18-40	20-42	22-45
	NC	-	-	13	19	25	30	34	38
12x06	CFM	325	434	542	650	759	867	975	1084
	Pt	.038	.068	.106	.152	.207	.271	.341	.422
	Throws	9-24	11-30	15-36	17-39	21-42	23-45	24-47	27-50
	NC	-	-	13	19	25	30	34	38
15x06	CFM	188	250	313	375	438	500	563	625
	Pt	.037	.063	.098	.141	.192	.250	.317	.391
	Throws	11-29	14-35	18-40	22-44	26-47	28-51	29-53	32-57
	NC	-	-	14	20	26	31	35	39
18x06	CFM	225	300	375	450	525	600	675	750
	Pt	.033	.059	.092	.133	.180	.236	.299	.369
	Throws	14-34	17-40	22-45	26-48	30-52	33-56	34-59	36-63
	NC	-	-	15	21	17	31	36	39
24x06	CFM	300	400	500	600	700	800	900	1000
	Pt	.030	.053	.083	.120	.164	.213	.271	.334
	Throws	17-39	23-45	28-51	32-56	35-60	36-64	40-68	41-72
	NC	-	-	14	20	25	30	35	38
30x06	CFM	375	500	625	750	875	1000	1125	1250
	Pt	.028	.049	.078	.112	.151	.198	.251	.309
	Throws	21-45	28-51	33-57	36-63	39-68	41-72	45-76	46-81
	NC	-	-	14	20	25	30	34	38
36x06	CFM	450	600	750	900	1050	1200	1350	1500
	Pt	.026	.047	.073	.105	.143	.186	.236	.291
	Throws	26-50	33-58	36-64	40-71	44-76	47-82	51-87	52-90
	NC	-	-	16	22	27	32	36	40
48x06	CFM	1000	1334	1667	2000	2334	2667	3000	3334
	Pt	.024	.043	.066	.095	.129	.169	.214	.264
	Throws	30-54	36-65	41-71	45-80	48-84	53-92	57-98	59-101
	NC	-	11	17	24	29	34	38	42

CONTINUED

SERIES XG-RL-SP PERFORMANCE DATA
MODEL XG-RL-SP

Size	Nk Vel	300	400	500	600	700	800	900	1000
	Pv	.006	.010	.016	.022	.031	.04	.050	.062
20x10	CFM	417	556	695	834	973	1112	1250	1389
	Pt	.026	.047	.074	.107	.145	.189	.240	.292
	Throws	22-46	30-53	34-59	38-64	40-70	44-75	46-78	48-83
	NC	-	-	16	22	27	32	36	40
30x10	CFM	625	834	1042	1250	1459	1667	1875	2084
	Pt	.023	.042	.065	.094	.128	.167	.211	.261
	Throws	28-54	35-63	40-70	23-77	28-83	52-88	54-93	57-99
	NC	-	10	17	23	28	30	38	41
40x10	CFM	834	1112	1389	1667	1945	2223	2500	2778
	Pt	.021	.037	.058	.083	.114	.149	.188	.233
	Throws	34-63	41-72	46-81	52-90	57-96	60-101	63-107	65-114
	NC	-	11	18	24	29	32	39	42
20x12	CFM	500	667	834	1000	1167	1334	1500	1667
	Pt	.024	.043	.066	.095	.129	.169	.214	.264
	Throws	27-50	33-58	38-64	41-70	44-76	47-81	50-86	52-90
	NC	-	-	16	23	38	33	37	41
30x12	CFM	750	1000	1250	1500	1750	2000	2250	2500
	Pt	.022	.039	.061	.088	.120	.157	.199	.244
	Throws	34-60	40-70	45-77	48-84	52-92	57-98	59-104	62-110
	NC	-	11	18	24	29	34	38	42
40x12	CFM	1000	1334	1667	2000	2334	2667	3000	3334
	Pt	.019	.035	.054	.079	.108	.140	.178	.219
	Throws	40-70	47-81	52-90	57-99	62-106	66-113	70-120	74-128
	NC	-	12	19	25	31	35	40	43

CONTINUED

SERIES XG-RL-SP PERFORMANCE DATA
MODEL XG-RL-SP

Size	Nk Vel	300	400	500	600	700	800	900	1000
	Pv	.006	.010	.016	.022	.031	.04	.050	.062
15x15	CFM	469	625	782	938	1094	1250	1407	1563
	Pt	.024	.044	.068	.097	.133	.173	.219	.271
	Throws	23-48	30-56	36-63	40-69	42-74	46-78	48-83	51-88
	NC	-	-	16	23	28	33	37	41
20x15	CFM	625	834	1042	1250	1459	1667	1875	2084
	Pt	.021	.042	.064	.092	.127	.165	.210	.257
	Throws	28-56	35-64	41-72	46-80	50-86	53-92	56-96	59-102
	NC	-	10	17	24	29	33	37	42
30x15	CFM	938	1250	1563	1875	2188	2500	2813	3125
	Pt	.020	.037	.057	.081	.112	.146	.184	.227
	Throws	33-63	40-72	47-82	53-90	57-98	60-105	63-110	68-117
	NC	-	11	18	25	30	34	38	43
35x15	CFM	1094	1459	1823	2188	2553	2917	3282	3646
	Pt	.019	.034	.053	.077	.105	.137	.173	.213
	Throws	39-70	46-81	49-92	59-101	64-110	68-118	71-123	76-131
	NC	-	12	19	26	30	35	39	43
40x15	CFM	1250	1667	2084	2500	2917	3334	3750	4167
	Pt	.030	.053	.083	.120	.164	.213	.271	.334
	Throws	17-39	23-45	28-51	32-56	35-60	36-64	40-68	41-72
	NC	-	-	14	20	25	30	35	38

Data based on units tested at 0° Blade Deflection.
 See chart below for other Blade Deflections.

Deflection	NC	Throws	Pt
15°	+ 4	x .85	x 1.2
30°	+ 8	x .69	x 1.8

PERFORMANCE NOTES FOR SERIES XG-RL-SP

All Data was tested in accordance with ANSI/ASHRAE 70-2006

DEFINITION OF UNITS:

CFM Air volume is cubic feet per minute

Nk Vel Neck Velocity is the airstream velocity in the duct just before it reaches the supply outlet; measured in feet per minute

NC Noise Criteria based on a room absorption of 10 dB, re: 10⁻¹² watts [NC less than 10 (-)]

Throw Throw distance in feet are for terminal velocities of 150 and 50 fpm respectively

Ps Static pressure is in inches of water

FILTER GRILLES

MODEL XG-RHF

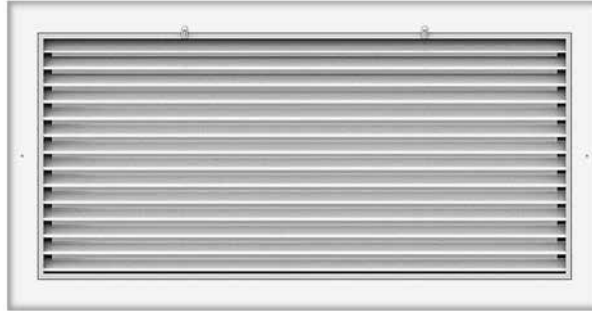

MODEL XG-CC5F

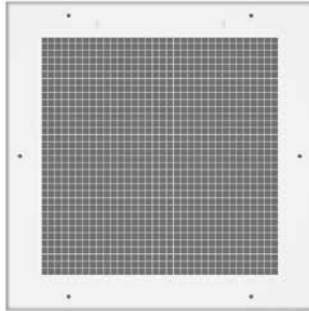

MODEL XG-RPF

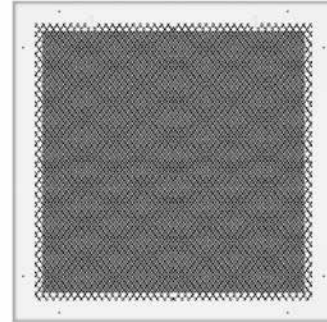

GREENHECK offers a complete line of return filter grilles available in steel or aluminum construction with louvered, egg crate or perforated face design.

Aluminum/Steel Louvered Filter Grille

The XG-RHF series of louvered filter grilles is available in aluminum or steel construction and is designed to accept 1" or 2" filters (by others). The hinged face design allows access to the filter and aids in the cleaning of the grille.

- XG-RHF – Aluminum louvered face filter grille
- XG-RHEF – Extruded aluminum louvered face filter grille
- XG-SRHF – Steel louvered face filter grille

PAGE 115

Aluminum Cubed Core Filter Grille

The XG-CC5F series of cubed core filter grilles is available in aluminum construction and is designed to accept 1" or 2" filters (by others). The hinged face design allows access to the filter and aids in the cleaning of the grille.

- XG-CC5F – Aluminum cubed core filter grille

PAGE 121

Aluminum/Steel Perforated Filter Grille

The XG-RPF series of perforated filter grilles is available in aluminum or steel construction and is designed to accept 1" or 2" filters (by others). The hinged face design allows access to the filter and aids in the cleaning of the grille.

- XG-RPF – Aluminum perforated filter grille
- XG-SRPF – Steel perforated filter grille

PAGE 125

MODEL XG-RHF

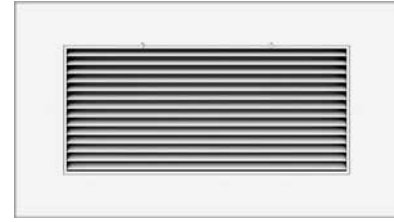

Model XG-RHF – Return Filter Grille - Aluminum
XG-RHF-1 - Surface Mount RHF-6 - T-bar Lay-in
XG-RHF-9 - Donn Fineline T-Bar

Air Inlets shall be model XG-RHF manufactured by GREENHECK. Units shall be filter return or exhaust grilles of aluminum construction and with an aluminum border and a single set of fixed deflection blades.

Units shall include a hinged face and integral frame designed to accept a 1" thick (optional 2" or 4" thick) filter. Filters are to be provided by others. Filter face shall be secured in place with 1/4" turn fasteners. The units shall be the size and quantity as outlined in the plans and specifications.

Border shall be 1 1/4" wide with aerodynamically shaped deflector blades on .666" centers set at 45°. Deflector blades shall be fixed.

Model XG-RHEF – Return Filter Grille - Extruded Aluminum
XG-RHEF-1 - Surface Mount
XG-RHEF-6 - T-bar Lay-in
XG-RHEF-9 - Donn Fineline T-bar

Air Inlets shall be model XG-RHEF manufactured by GREENHECK. Units shall be filter return or exhaust grilles constructed of heavy extruded aluminum.

Unit shall include a hinged face and integral frame designed to accept a 1" thick (optional 2" or 4" thick) filter. Filters are to be provided by others. Filter face shall be secured in place with 1/4" turn fasteners. The units shall be the size and quantity as outlined in the plans and specifications.

Border shall be 1 1/4" wide with aerodynamically shaped fixed deflector blades on .666" centers set at 45°. Deflector blades shall be fixed.

Model XG-SRHF – Return Filter Grille - Steel**XG-SRHF-1 - Surface Mount****XG-SRHF-6 - T-bar Lay-in****XG-SRHF-9 - Donn Fineline T-bar**

Air Inlets shall be model XG-SRHF manufactured by GREENHECK. Units shall be filter return or exhaust grilles constructed of steel.

Unit shall include a hinged face and integral frame designed to accept a 1” thick (optional 2” thick) filter. Filters are to be provided by others. Filter face shall be secured in place with 1/4 turn fasteners. The units shall be the size and quantity as outlined in the plans and specifications.

Border shall be 1 1/4” wide with aerodynamically shaped fixed deflector blades on .666” centers set at 45°. Deflector blades shall be fixed.

For Surface mounting:

Units shall be designed for surface mounting applications and be provided with counter sunk screw holes on the face of the device.

For T-Bar Lay-in:

Units shall be designed to integrate into the specified ceiling system.

Damper Accessories (Optional):

Optional opposed blade damper shall be constructed of steel (model XG-OBD) or aluminum (model XG-OBDA). Damper must be operable from the face of the diffuser.

Performance Specification

The manufacturer shall provide published performance data. Data shall be tested in accordance to ANSI/ASHRAE Standard 70- 2006

Paint Specification:

Process shall be anodic electrodeposition using an anodic acrylic paint. Units shall undergo pre-treatment including a pressurized spray stage using an alkaline cleaner and a de-ionized water rinse.

MODEL XG-RHF

Filter Back Return Grilles and Registers Roll Formed Aluminum - 45° Louvered Face

Models: XG-RHF-1 Filter Return Grille - Surface Mount
 XG-RHF-6 Filter Return Grille - Lay in T-Bar

Model: XG-RHF-1 (Filter Return Grille - Surface Mount)

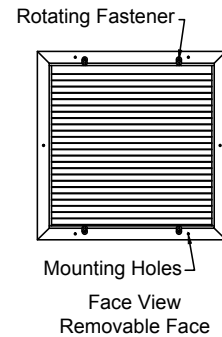
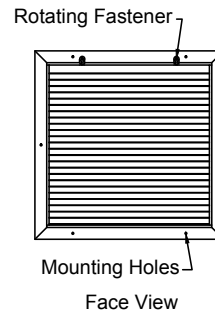
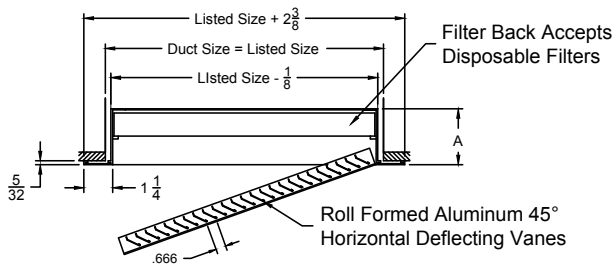

Model: XG-RHF-6 (Filter Return Grille - Lay in T-Bar)

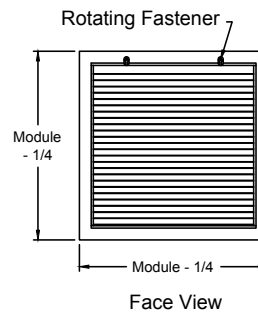
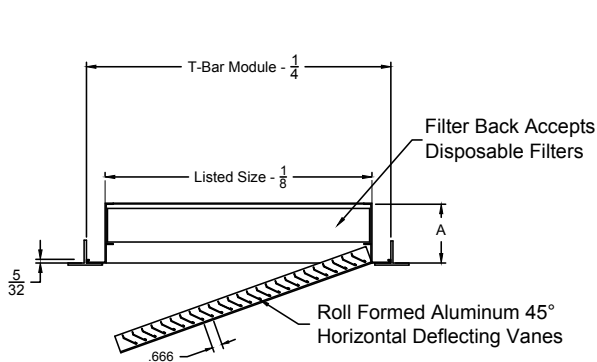

Disposable Filter Thickness	Dimension A
1"	2-7/16
2"	3-7/16

Disposable Filter Thickness	Dimension B
1"	3-15/16
2"	4-15/16

MODEL XG-RHEF

Filter Back Return Grilles and Registers Extruded Aluminum Blades and Frame - 45° Louvered Face

- Models: **XG-RHEF-1** Filter Return Grille - Surface Mount
 XG-RHEF-6 Filter Return Grille - Lay in T-Bar
 XG-RHEF-9 Filter Return Grille - Bolt Slot Ceiling Grid

Model: XG-RHEF-1 - Filter Return Grille - Surface Mount

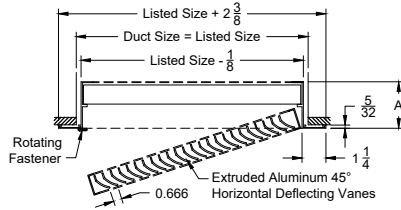

Model: XG-RHEF-6 - Filter Return Grille - Lay in T-Bar

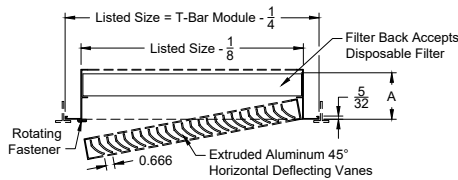

Model: XG-RHEF-9 - Return Grille - Bolt Slot Ceiling Grid

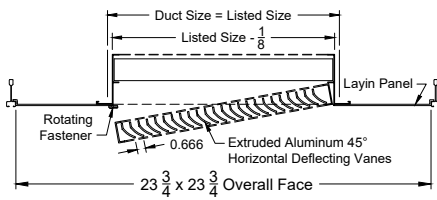

Damper Options
 XG-OBDD: Steel Opposed Blade Damper
 XG-OBDA: Aluminum Opposed Blade Damper

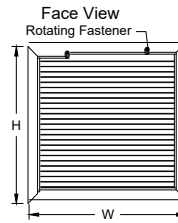
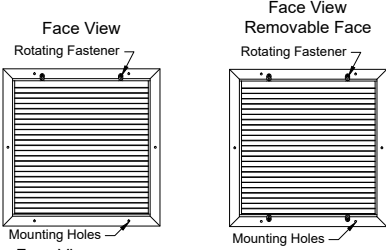
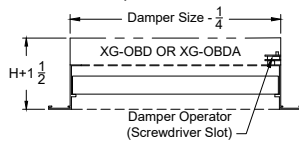

Disposable Filter Thickness	Dimension A
1"	2 7/16"
2"	3 7/16"

Disposable Filter Thickness	Dimension B
1"	3 15/16"
2"	4 15/16"

Face View - XG-RHEF-9

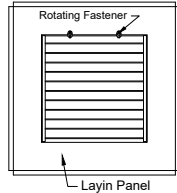

Panel Sizes
12 x 12
24 x 12
24 x 24

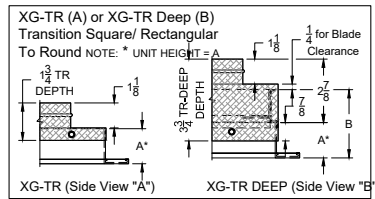

Notes: (check if provided)

Note: This product complies with the requirements of NFPA 90A-18, Sections 4.3.7.3.2 & 4.3.8.3.2.

1. Available Finishes	2. Available Accessories	3. Available Options	4. Construction Details
Standard Finish: <input type="checkbox"/> 01 White. Optional Finish (no extra Charge): <input type="checkbox"/> 24 Mill Finish Optional Finish (extra Charge): <input type="checkbox"/> 02 Satin Silver <input type="checkbox"/> 03 Black. <input type="checkbox"/> 28 Custom Color / Setup Charge	<input type="checkbox"/> XG-OBDD-Steel Opposed Blade Damper <input type="checkbox"/> XG-OBDA - Aluminum Opposed Blade Damper. <input type="checkbox"/> XG-L9 - Equalizing Grid. <input type="checkbox"/> XG-PF - Plaster Frame. <input type="checkbox"/> XG-TBPF - T-Bar Plaster Frame. <input type="checkbox"/> XG-TR - Transition from Square/Rectangular to Round Up to 22 x 22 <input type="checkbox"/> XG-TR - Deep- Used with Dampers <input type="checkbox"/> XG-LIPF - Lay-In Plaster Frame	<input type="checkbox"/> IN - Insect Screen <input type="checkbox"/> Removable face <input type="checkbox"/> 2" FF-2" Filter Rack	<ul style="list-style-type: none"> Frame and Blades are extruded Aluminum. Can be ordered with smaller neck size in T-Bar panels.

SERIES XG-RHF PERFORMANCE DATA
MODEL XG-RHF, XG-RHEF, XG-SRHF

Size	Duct Area ft ²	Nk Vel	200	300	400	500	600	700	800	900	1000
		Ps	-.009	-.020	-.036	-.056	-.081	-.110	-.143	-.181	-.223
06x06	.25	CFM	39	58	77	96	115	134	153	172	191
		NC	-	-	15	20	25	29	32	35	38
08x06	.33	CFM	53	79	106	132	159	185	212	238	265
		NC	-	-	16	21	26	30	34	37	39
10x06	.42	CFM	69	103	137	171	205	239	273	307	341
		NC	-	-	17	23	27	31	35	38	40
08x08	.44	CFM	75	112	149	186	223	260	297	334	371
		NC	-	12	18	23	28	32	36	39	41
12x06	.50	CFM	83	124	165	206	247	288	329	370	411
		NC	-	12	18	23	28	32	36	39	41
16x06 12x08	.67	CFM	115	172	229	286	343	400	457	514	571
		NC	-	12	19	25	30	34	37	40	43
10x10	.69	CFM	119	178	237	296	355	414	473	532	591
		NC	-	12	19	25	30	34	37	40	43
12x10 20x06	.83	CFM	145	217	289	361	433	505	577	649	721
		NC	-	13	20	26	31	35	38	41	44
24x06 12x12	1.00	CFM	177	265	353	441	529	617	705	793	881
		NC	-	14	21	27	32	36	39	42	45
14x14	1.36	CFM	245	367	489	611	733	855	977	1099	1221
		NC	-	15	22	28	33	37	40	43	46
18x12 36x06	1.50	CFM	271	406	541	676	811	946	1081	1216	1351
		NC	-	16	23	29	33	37	41	44	47
18x16 24x12	2.00	CFM	365	547	729	911	1093	1275	1457	1639	1821
		NC	11	17	24	30	35	39	42	45	48
18x18	2.25	CFM	415	622	829	1036	1243	1450	1657	1864	2071
		NC	11	17	25	31	35	39	43	46	48
30x12	2.50	CFM	459	688	917	1146	1375	1604	1833	2062	2291
		NC	12	18	25	31	36	40	43	46	49
20x20	2.78	CFM	515	772	1029	1286	1543	1800	2057	2314	2571
		NC	12	18	26	31	36	40	43	47	49
24x18 36x12	3.00	CFM	551	826	1101	1376	1651	1926	2201	2476	2751
		NC	13	19	26	32	36	40	44	47	50
22x22	3.36	CFM	629	943	1257	1571	1885	2199	2513	2827	3141
		NC	13	19	27	32	37	41	44	47	50
48x12 24x24	4.00	CFM	752	1127	1503	1878	2254	2630	3005	3381	3756
		NC	-	20	28	33	38	42	46	49	51

CONTINUED

SERIES XG-RHF PERFORMANCE DATA
MODEL XG-RHF, XG-RHEF, XG-SRHF

Size	Duct Area ft ²	Nk Vel	200	300	400	500	600	700	800	900	1000
		Ps	-.009	-.020	-.036	-.056	-.081	-.110	-.143	-.181	-.223
48x18 36x24	6.00	CFM	1133	1699	2265	2831	3397	3963	4529	5095	5661
		NC	11	22	29	35	40	44	47	50	53
48x24 36x32	8.00	CFM	1527	2290	3053	3816	4579	5342	6105	6868	7631
		NC	13	24	31	37	42	46	49	52	55
48x36	12.00	CFM	2315	3472	4629	5786	6943	8100	9257	10414	11571
		NC	14	25	32	38	43	47	50	53	56
48x48	16.00	CFM	3102	4653	6204	7755	9306	10857	12408	13959	15510
		NC	16	26	33	39	44	48	51	54	57

PERFORMANCE NOTES FOR SERIES XG-RHF, XG-RHEF, XG-SRHF

All data is tested in accordance with ANSI/ASHRAE 70-2006.

DEFINITION OF UNITS

CFM Cubic Feet per Minute (Air)

Nk Vel Neck velocity of air stream in Feet Per Minute

Ps Negative Static pressure (inches of water column)

NC Noise criterion, sound pressure level. NC ratings are based on sound power level (Lw)

RE: 10⁻¹² watts minus a 10dB room attenuation in all octave bands.

MODEL XG-CC5F

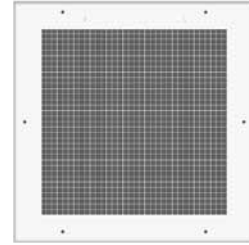

Cube Core Return Filter Grille
XG-CC5F-1 Surface Mount
XG-CC5F-6 T-bar Lay-in
XG-CC5F-9 Donn Finline T-bar

Air Inlets shall be model XG-CC5F with a 1/2" x 1/2" x 1/2" cubed core manufactured by GREENHECK. Border shall be 1 1/4" wide. Units shall be filter return or exhaust grilles of aluminum construction and with an extruded aluminum border and an aluminum cubed core.

Units shall include a hinged face and integral frame designed to accept a 1" (2" or 4" optional) thick filter. Filters are to be provided by others. Filter face shall be secured in place with 1/4" turn fasteners.

The units shall be the size and quantity as outlined in the plans and specifications.

For Surface mounting:

Units shall be designed for surface mounting applications and be provided with counter sunk screw holes on the face of the device.

For T-Bar Lay-in:

Units shall be designed to integrate into the specified ceiling system.

Damper Accessories (Optional):

Optional opposed blade damper shall be constructed of steel (model XG-OBD) or aluminum (model XG-OBDA). Damper must be operable from the face of the diffuser.

Performance Specification

The manufacturer shall provide published performance data. Data shall be tested in accordance to ANSI/ASHRAE Standard 70- 2006

Paint Specification:

Process shall be anodic electrodeposition using an anodic acrylic paint. Units shall undergo pre-treatment including a pressurized spray stage using an alkaline cleaner and a de-ionized water rinse.

MODEL XG-CC5F

Filter Back Return Grilles and Registers Aluminum - 1/2" x 1/2" x 1/2" Cube Core

- Models: **XG-CC5F-1** Return Grille - Surface Mount
 XG-CC5F-6 Return Grille - Lay-in T-Bar
 XG-CC5F-9 Return Grille - Bolt Slot Ceiling Grid

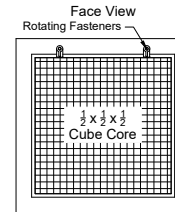
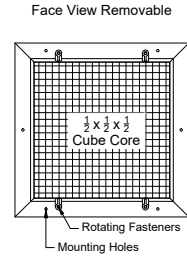
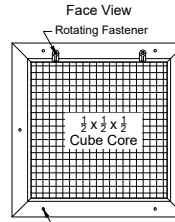
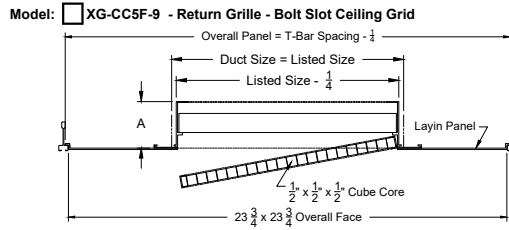
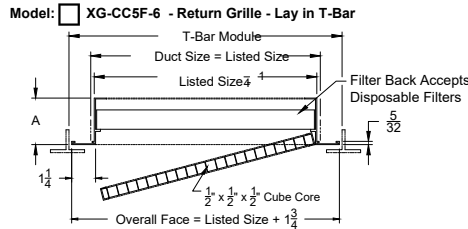
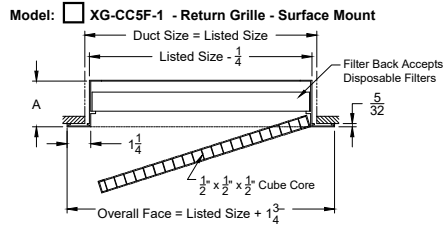

Disposable Filter Thickness	Dimension A
1"	2 7/16"
2"	3 7/16"

Disposable Filter Thickness	Dimension B
1"	3 15/16"
2"	4 15/16"

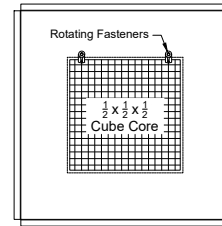

Damper Options XG-OBD: Steel Opposed Blade Damper XG-OBDA: Aluminum Opposed Blade Damper

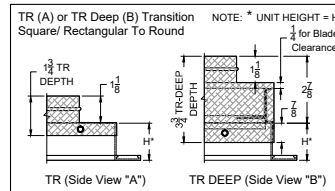
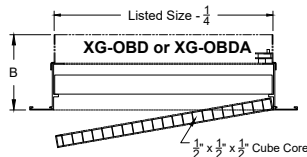

Notes: (check if provided)

Note: This product complies with the requirements of NFPA 90A-18, Sections 4.3.7.3.2 & 4.3.8.3.2.

1. Available Finishes	2. Available Accessories	3. Available Options	4. Construction Details
Standard Finish: <input type="checkbox"/> 01 White. Optional Finish (no extra Charge): <input type="checkbox"/> 24 Mill Finish Optional Finish (extra Charge): <input type="checkbox"/> 02 Satin Silver <input type="checkbox"/> 03 Black. <input type="checkbox"/> 28 Custom Color / Setup Charge	<input type="checkbox"/> XG-OBD - Steel Opposed Blade Damper <input type="checkbox"/> XG-OBDA - Aluminum Opposed Blade Damper. <input type="checkbox"/> XG-L9 - Equalizing Grid. <input type="checkbox"/> XG-PF - Plaster Frame. <input type="checkbox"/> XG-TBPF - T-Bar Plaster Frame. <input type="checkbox"/> XG-TR - Transition from Square/Rectangular to Round Up to 22 x 22 <input type="checkbox"/> XG-TR - Deep - Used with Dampers <input type="checkbox"/> XG-LIPF - Lay-In Plaster Frame	<input type="checkbox"/> IS - Insect Screen <input type="checkbox"/> Removable face <input type="checkbox"/> 2" FF-2" Filter Rack	<ul style="list-style-type: none"> Frame and Cube Core are Aluminum.

SERIES XG-CC5F PERFORMANCE DATA
MODEL XG-CC5F

Size	Duct Area ft ²	Nk Vel	200	300	400	500	600	700	800	900	1000
		Ps	-.006	-.013	-.024	-.037	-.054	-.073	-.095	-.120	-.149
06x06	.25	CFM	46	69	92	115	138	161	184	207	230
		NC	-	-	-	-	-	14	18	22	26
08x06	.33	CFM	61	92	122	152	183	213	243	274	304
		NC	-	-	-	-	-	15	19	23	27
10x06	.42	CFM	77	115	154	192	230	268	307	345	383
		NC	-	-	-	-	11	16	20	24	28
08x08	.44	CFM	83	125	166	204	249	291	332	374	415
		NC	-	-	-	-	11	16	21	25	28
12x06	.50	CFM	92	139	185	232	279	325	372	418	465
		NC	-	-	-	-	12	17	21	25	29
16x06 12x08	.67	CFM	126	189	253	317	378	442	506	570	630
		NC	-	-	-	-	13	18	22	26	30
10x10	.69	CFM	131	196	261	327	392	457	522	588	653
		NC	-	-	-	-	13	18	22	26	30
12x10 20x06	.83	CFM	157	235	313	391	469	547	625	703	781
		NC	-	-	-	-	13	18	23	26	30
24x06 12x12	1.00	CFM	191	287	382	478	573	669	764	860	955
		NC	-	-	-	-	14	19	24	28	31
14x14	1.36	CFM	260	390	520	650	780	910	1040	1169	1299
		NC	-	-	-	-	15	20	25	29	32
18x12 36x06	1.50	CFM	287	430	573	717	860	1003	1146	1290	1433
		NC	-	-	-	-	16	21	25	29	33
18x16 24x12	2.00	CFM	382	573	764	955	1146	1337	1528	1719	1910
		NC	-	-	-	11	17	22	26	30	33
18x18	2.25	CFM	430	645	860	1075	1290	1505	1719	1934	2149
		NC	-	-	-	11	17	22	26	30	34
30x12	2.50	CFM	478	717	955	1194	1433	1672	1910	2149	2388
		NC	-	-	-	11	17	23	27	31	34
20x20	2.78	CFM	531	797	1062	1328	1593	1859	2124	2390	2655
		NC	-	-	-	12	18	23	27	31	35
24x18 36x12	3.00	CFM	573	860	1146	1433	1719	2006	2292	2579	2865
		NC	-	-	-	12	18	23	28	32	35
22x22	3.36	CFM	642	963	1284	1605	1926	2247	2568	2888	3209
		NC	-	-	-	12	18	23	28	32	35
48x12 24x24	4.00	CFM	768	1152	1536	1920	2304	2688	3072	3456	3840
		NC	-	-	-	13	19	24	29	33	36
48x18 36x24	6.00	CFM	1152	1728	2304	2880	3456	4032	4608	5184	5760
		NC	-	-	-	15	21	26	30	34	38

CONTINUED

SERIES XG-CC5F PERFORMANCE DATA
MODEL XG-CC5F

Size	Duct Area ft ²	Nk Vel	200	300	400	500	600	700	800	900	1000
		Ps	-.006	-.013	-.024	-.037	-.054	-.073	-.095	-.120	-.149
48x24 36x32	8.00	CFM	1536	2304	3072	3840	4608	5376	6144	6912	7680
		NC	-	-	-	16	22	27	31	35	39
48x36	12.00	CFM	2304	3456	4608	5760	6912	8064	9216	10368	11520
		NC	-	-	11	17	23	28	33	37	40
48x48	16.00	CFM	3072	4608	6144	7680	9216	10752	12288	13824	15360
		NC	-	-	12	18	24	29	34	38	41

PERFORMANCE NOTES FOR SERIES XG-CC5F

All data is tested in accordance with ANSI/ASHRAE 70-2006.

DEFINITION OF UNITS

CFM Cubic Feet per Minute (Air)

Velocity Neck Velocity of air stream in Feet Per Minute

Ps Negative Static pressure = $P_t - P_v$ (inches of water column)

NC Noise criterion, Sound pressure level. NC ratings are based on sound power level (Lw)

RE: 10^{-12} watts minus a 10dB room attenuation in all octave bands.

MODEL XG-RPF

Air Inlets shall be model XG-RPF manufactured by GREENHECK. Units shall be perforated face, return or exhaust grilles constructed of aluminum. Perforated face shall have 3/16" diameter holes on 1/4" centers and shall have a 51% free area. Units shall include a hinged face and integral frame designed to accept a 1" thick filter. Filter face shall be secured in place with 1/4 turn fasteners. The units shall be the size and quantity as outlined in the plans and specifications. Border shall be 1 1/4". Units shall be designed for surface mounting applications and be provided with counter sunk screw holes on the face of the device.

Damper Accessories (Optional)

Optional opposed blade damper shall be constructed of steel (Model XG-OBD) or aluminum (Model XG-OBDA). Damper must be operable from the face of the diffuser.

Performance Specification

The manufacturer shall provide published performance data. Data shall be tested in accordance to ANSI/ASHRAE Standard 70-2006

Model: □ XG-RPF-1 (Return Grille - Surface Mount)

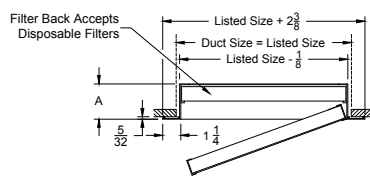

Face view

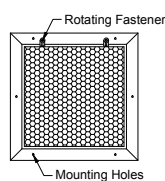

Face view
Removable Face

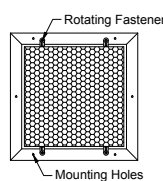

Model: □ XG-RPF-6 (Return Grille - Lay in T-Bar)

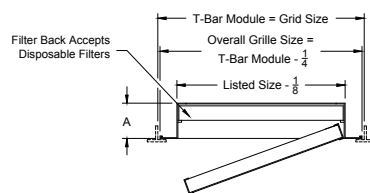

Face view

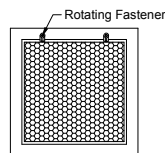

Lay-in T-Bar Modules for RPF - 6

24 x 24	48 x 24
Listed Sizes	
22 x 22	46 x 22
Overall Dimensions W x H	
23 3/4 x 23 3/4	47 3/4 x 23 3/4

Damper Options:

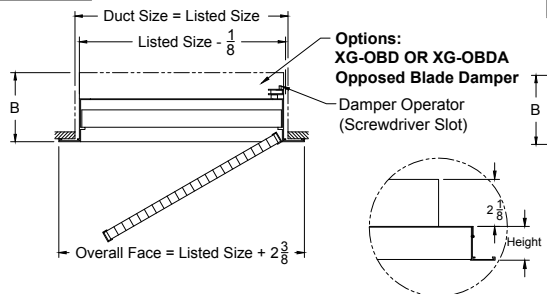

□ XG-TR (A)/XG-TR Deep (B) T
Square/Rectangular To Round

Disposable Filter Thickness	Dimension A
1	2 7/16
2	3 7/16

Disposable Filter Thickness	Dimension B
1	3 15/16
2	4 15/16

XG-RPF MODEL NUMBER SPECIFICATION
PERFORATED FILTER GRILLE – ALUMINUM/STEEL

Model		Neck											
XG-RPF-1	Aluminum Surface Mount		6	8	10	12	14	16	18	20	22	24	26
XG-SRPF-1	Steel Surface Mount	4	X	X	X	X	X	X	X	X	X	X	X
		5	X	X	X	X	X	X	X	X	X	X	X
		6	X	X	X	X	X	X	X	X	X	X	X
		8	X	X	X	X	X	X	X	X	X	X	X
		10	X	X	X	X	X	X	X	X	X	X	X
		12	X	X	X	X	X	X	X	X	X	X	X
		14	X	X	X	X	X	X	X	X	X	X	X
		16	X	X	X	X	X	X	X	X	X	X	X
		18	X	X	X	X	X	X	X	X	X	X	X
		20	X	X	X	X	X	X	X	X	X	X	X
		22	X	X	X	X	X	X	X	X	X	X	X
		24	X	X	X	X	X	X	X	X	X	X	X
		26	X	X	X	X	X	X	X	X	X	X	X
		28	X	X	X	X	X	X	X	X	X	X	X
		30	X	X	X	X	X	X	X	X	X	X	X
		32	X	X	X	X	X	X	X	X	X	X	X
		34	X	X	X	X	X	X	X	X	X	X	X
		36	X	X	X	X	X	X	X	X	X	X	X

Available Finishes		Available Accessories	
Standard		XG-OB	Steel Opposed Blade Damper
01	White	XG-OBDA	Aluminum Opposed Blade Damper
Optional		XG-PF	Plaster Frame
02	Satin Silver	XG-LIPF	Lay-in Plaster Frame
03	Black	IS	Insect Screen
24	Mill (Aluminum Construction Only)	XG-TR	Square to Round Transition
28	Custom Color	XG-TR Deep	Deep Square to Round Transition

Available Options	
NSH	No Screw Holes
CM	Concealed Mounting

**XG-RPF MODEL NUMBER SPECIFICATION
PERFORATED FILTER GRILLE – ALUMINUM/STEEL**

Model		Neck											
XG-RPF-1	Aluminum Surface Mount		28	30	32	34	36	38	40	42	44	46	48
XG-SRPF-1	Steel Surface Mount	4	X	X	X	X	X	X	X	X	X	X	X
		5	X	X	X	X	X	X	X	X	X	X	X
		6	X	X	X	X	X	X	X	X	X	X	X
		8	X	X	X	X	X	X	X	X	X	X	X
		10	X	X	X	X	X	X	X	X	X	X	X
		12	X	X	X	X	X	X	X	X	X	X	X
		14	X	X	X	X	X	X	X	X	X	X	X
		16	X	X	X	X	X	X	X	X	X	X	X
		18	X	X	X	X	X	X	X	X	X	X	X
		20	X	X	X	X	X	X	X	X	X	X	X
		22	X	X	X	X	X	X	X	X	X	X	X
		24	X	X	X	X	X	X	X	X	X	X	X
		26	X	X	X	X	X	X	X	X	X	X	X
		28	X	X	X	X	X	X	X	X	X	X	X
		30	X	X	X	X	X	X	X	X	X	X	X
		32	X	X	X	X	X	X	X	X	X	X	X
		34	X	X	X	X	X	X	X	X	X	X	X
		36	X	X	X	X	X	X	X	X	X	X	X

Available Finishes		Available Accessories	
Standard		XG-OBDA	Steel Opposed Blade Damper
01	White	XG-OBDA	Aluminum Opposed Blade Damper
Optional		XG-PF	Plaster Frame
02	Satin Silver	XG-LIPF	Lay-in Plaster Frame
03	Black	IS	Insect Screen
24	Mill (Aluminum Construction Only)	XG-TR	Square to Round Transition
28	Custom Color	XG-TR Deep	Deep Square to Round Transition

Available Options	
NSH	No Screw Holes
CM	Concealed Mounting

XG-RPF MODEL NUMBER SPECIFICATION
PERFORATED FILTER GRILLE – ALUMINUM/STEEL

Model		Neck										Module			
			6	8	10	12	14	16	18	20	22		24		
XG-RPF-6	Aluminum - Lay-in														
XG-SRPF-6	Steel - Lay-in	4	X	X											12 x 12
		6	X	X											
		8	X	X											
		10			X										24 x 12
		4	X	X	X	X	X	X	X	X					
		6	X	X	X	X	X	X	X	X					
		8	X	X	X	X	X	X	X	X					24 x 24
		10									X				
		4	X	X	X	X	X	X	X	X					
		6	X	X	X	X	X	X	X	X					48 x 24
		8	X	X	X	X	X	X	X	X					
		10	X	X	X	X	X	X	X	X					
		12	X	X	X	X	X	X	X	X					
		14	X	X	X	X	X	X	X	X					
		16	X	X	X	X	X	X	X	X					
		18	X	X	X	X	X	X	X	X					
		20	X	X	X	X	X	X	X	X					
		22									X				
		4	X	X	X	X	X	X	X	X	X	X			
		6	X	X	X	X	X	X	X	X	X	X			
		8	X	X	X	X	X	X	X	X	X	X			
		10	X	X	X	X	X	X	X	X	X	X			
		12	X	X	X	X	X	X	X	X	X	X			
		14	X	X	X	X	X	X	X	X	X	X			
		16	X	X	X	X	X	X	X	X	X	X			
		18	X	X	X	X	X	X	X	X	X	X			
		20	X	X	X	X	X	X	X	X	X	X			

Available Finishes		Available Accessories	
Standard		XG-OB	Steel Opposed Blade Damper
01	White	XG-OBDA	Aluminum Opposed Blade Damper
Optional		XG-TBPF	T-bar Plaster Frame
02	Satin Silver	IS	Insect Screen
03	Black	XG-TR	Square to Round Transition
24	Mill (Aluminum Construction Only)	XG-TR Deep	Deep Square to Round Transition
28	Custom Color		

**XG-RPF MODEL NUMBER SPECIFICATION
PERFORATED FILTER GRILLE – ALUMINUM/STEEL**

Model		Neck												Module
XG-RPF-6	Aluminum - Lay-in	26	28	30	32	34	36	38	40	42	44	46		
XG-SRPF-6	Steel - Lay-in	4	X	X	X	X	X	X	X	X	X	X	48 x 24	
		6	X	X	X	X	X	X	X	X	X			
		8	X	X	X	X	X	X	X	X	X			
		10	X	X	X	X	X	X	X	X	X			
		12	X	X	X	X	X	X	X	X	X			
		14	X	X	X	X	X	X	X	X	X			
		16	X	X	X	X	X	X	X	X	X			
		18	X	X	X	X	X	X	X	X	X			
		20	X	X	X	X	X	X	X	X	X			
		22										X		

Available Finishes		Available Accessories	
Standard		XG-OBDA	Steel Opposed Blade Damper
01	White	XG-OBDA	Aluminum Opposed Blade Damper
Optional		XG-TBPF	T-bar Plaster Frame
02	Satin Silver	IS	Insect Screen
03	Black	XG-TR	Square to Round Transition
24	Mill (Aluminum Construction Only)	XG-TR Deep	Deep Square to Round Transition
28	Custom Color		

SERIES XG-RPF PERFORMANCE DATA
MODEL XG-RPF

Size	Duct Area ft ²	Nk Vel	300	400	500	600	700	800	900	1000	1100
		Ps	-.023	-.041	-.064	-.092	-.126	-.165	-.209	-.259	-.314
06x06	.25	CFM	58	77	96	116	135	154	173	192	212
		NC	-	-	13	16	18	21	22	24	25
08x06	.33	CFM	81	107	134	161	187	214	241	267	294
		NC	-	11	15	18	20	22	24	24	27
10x06	.42	CFM	103	137	171	205	239	273	307	341	376
		NC	-	12	16	19	21	23	25	27	28
08x08	.44	CFM	112	149	186	223	260	297	334	371	409
		NC	-	13	16	19	21	24	25	27	28
12x06	.50	CFM	124	165	206	248	289	330	371	412	454
		NC	-	13	17	19	22	24	26	27	29
16x06 12x08	.67	CFM	172	229	286	343	400	457	514	571	629
		NC	-	15	18	21	23	26	27	29	30
10x10	.69	CFM	178	237	296	355	414	473	532	591	651
		NC	-	15	18	21	23	25	27	29	30
18x06	.75	CFM	190	253	316	379	442	505	568	631	695
		NC	11	15	18	21	24	26	28	29	31
24x06 12x12	1.00	CFM	265	353	441	529	617	705	793	881	970
		NC	12	16	20	23	25	27	29	31	32
30x06 18x10	1.25	CFM	334	445	556	667	778	889	1000	1111	1223
		NC	13	17	21	24	26	28	30	32	33
36x06 18x12	1.50	CFM	406	541	676	811	946	1081	1216	1351	1487
		NC	14	18	22	25	27	29	31	32	34
42x06 18x14	1.75	CFM	478	637	796	955	1114	1273	1432	1591	1751
		NC	15	19	22	25	28	30	32	33	35
24x12 18x16	2.00	CFM	547	729	911	1093	1275	1457	1639	1821	2004
		NC	15	20	23	26	28	30	32	34	35
30x12	2.50	CFM	688	917	1146	1375	1604	1833	2062	2291	2521
		NC	16	21	24	27	29	31	33	35	36
36x12	3.00	CFM	826	1101	1376	1651	1926	2201	2476	2751	3027
		NC	17	21	25	28	30	32	34	35	37
42x12 36x14	3.50	CFM	967	1289	1611	1933	2255	2577	2899	3221	3544
		NC	17	22	25	28	31	33	34	36	38
48x12 24x24	4.00	CFM	1126	1501	1876	2251	2626	3001	3376	3751	4127
		NC	18	23	26	29	31	34	35	37	38
36x20 30x24	5.00	CFM	1414	1885	2356	2827	3298	3769	4240	4711	5183
		NC	19	24	27	30	32	34	36	38	39
48x18 36x24	6.00	CFM	1699	2265	2831	3397	3963	4529	5095	5661	6228
		NC	20	24	28	31	33	35	37	39	40
48x24 36x32	8.00	CFM	2290	3053	3816	4579	5342	6105	6868	7631	8395
		NC	21	26	39	32	34	36	38	40	41

CONTINUED

SERIES XG-RPF PERFORMANCE DATA
MODEL XG-RPF

Size	Duct Area ft ²	Nk Vel	300	400	500	600	700	800	900	1000	1100
		Ps	-.023	-.041	-.064	-.092	-.126	-.165	-.209	-.259	-.314
48x36	12.00	CFM	3472	4629	5786	6943	8100	9257	10414	11571	12729
		NC	23	28	31	34	36	38	40	42	43
48x48	16.00	CFM	4653	6204	7755	9306	10857	12408	13959	15510	17061
		NC	24	29	32	35	37	40	41	43	44

PERFORMANCE NOTES FOR SERIES XG-RPF

All data is tested in accordance with ANSI/ASHRAE 70-2006.

DEFINITION OF UNITS

CFM Cubic Feet per Minute (Air)

Nk Vel Neck velocity of air stream in Feet Per Minute

Ps Negative Static pressure (inches of water column)

NC Noise criterion, Sound pressure level. NC ratings are based on sound power level (lw)

RE: 10⁻¹² watts minus a 10dB room attenuation in all octave bands.

HEAVY DUTY GRILLES

MODEL XG-HDRH

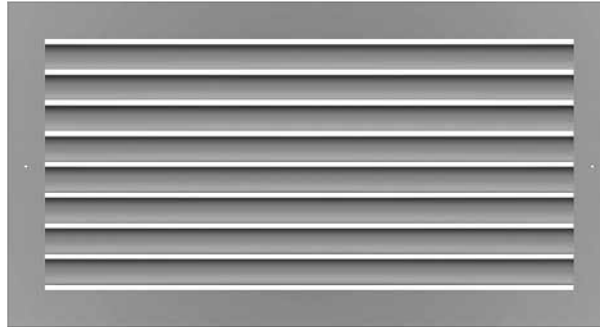

MODEL XG-4500

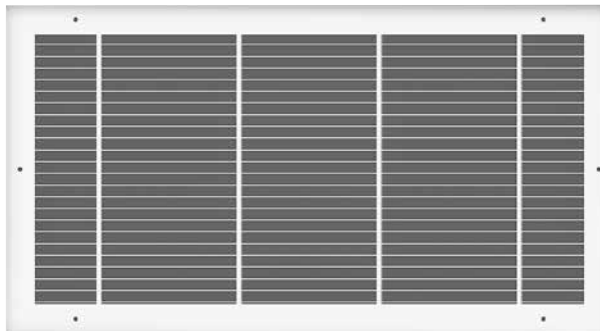

GREENHECK heavy duty grilles are designed to withstand moderate abuse. These grilles are available in steel and aluminum construction.

Aluminum Heavy Duty Return

The XG-HDRH series of heavy duty grilles is available in aluminum construction and is designed to withstand moderate physical abuse. Applications for the XG-HDRH include common areas in schools, hospitals and other high traffic areas.

- XG-HDRH – Aluminum heavy duty return

PAGE 133

Steel Heavy Duty Gym Grille

The XG-4500 series of heavy duty gym grille is available in steel construction with 0° or 38° blade deflection. The border and deflection blades are heavy gauge steel and are built to withstand moderate physical abuse.

- XG-4500 – Steel heavy duty gym grille - 0° deflection
- XG-4538 – Steel heavy duty gym grille - 38° deflection

PAGE 138

MODEL XG-HDRH

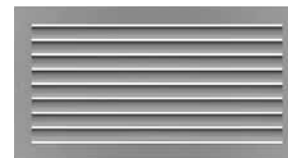

Return Grilles – Heavy Duty - Extruded Aluminum

Air Inlets shall be model XG-HDRH manufactured by GREENHECK. Units shall be heavy duty return or exhaust grilles of extruded aluminum construction.

Extrusion thickness shall be equal or greater than the equivalent of 14 gauge steel. Units shall be designed to withstand moderate physical abuse. The units shall be the size and quantity as outlined in the plans and specifications.

Border shall be 1 5/8" wide with aerodynamically shaped curved blades on 1 1/3" centers. Deflector blades shall be fixed in place heavy alloy metal screws.

Units shall be designed for surface mounting applications and be provided with counter sunk screw holes on the face of the device.

Damper Accessories (Optional)

Optional opposed blade damper shall be constructed of steel (Model XG-OBD) or aluminum (Model XG-OBDA). Damper must be operable from the face of the diffuser.

Performance Specification

The manufacturer shall provide published performance data. Data shall be tested in accordance to ANSI/ASHRAE Standard 70- 2006

Model: XG-HDRH-1 (1 1/3 Blade Spacing Louver Grille - Surface Mount)

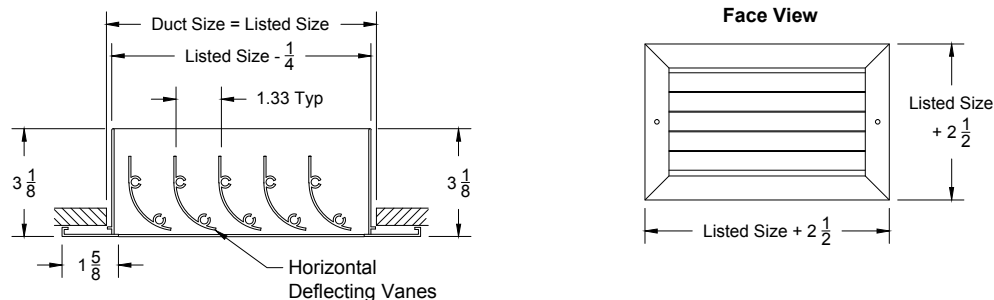

Option: XG-HDRH-1 XG-OBD (1 1/3 Blade Spacing Louver Register -Surface Mount - With Opposed Blade Damper)

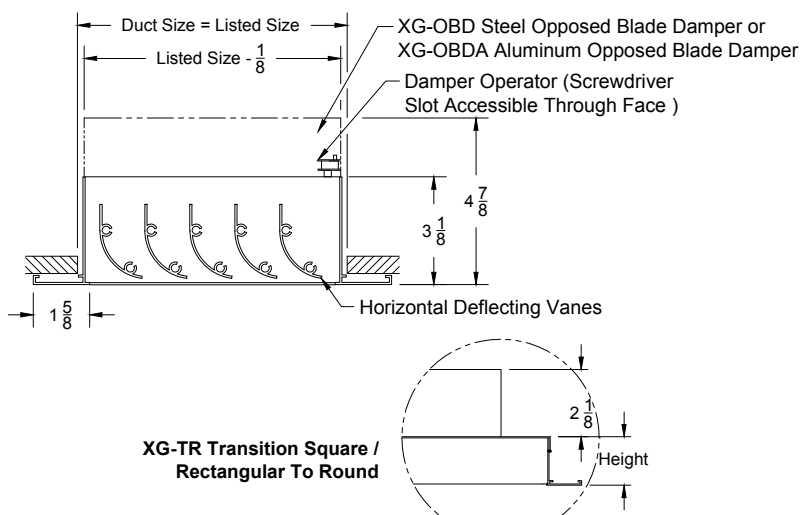

XG-TR Transition Square / Rectangular To Round

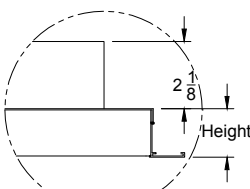

XG-HDRH MODEL NUMBER SPECIFICATIONS
HEAVY DUTY RETURN

Model		Neck										
XG-HDRH-1	Aluminum Surface Mount	6	8	10	12	14	16	18	20	22	24	26
4	X	X	X	X	X	X	X	X	X	X	X	X
5	X	X	X	X	X	X	X	X	X	X	X	X
6	X	X	X	X	X	X	X	X	X	X	X	X
8	X	X	X	X	X	X	X	X	X	X	X	X
10	X	X	X	X	X	X	X	X	X	X	X	X
12	X	X	X	X	X	X	X	X	X	X	X	X
14	X	X	X	X	X	X	X	X	X	X	X	X
16	X	X	X	X	X	X	X	X	X	X	X	X
18	X	X	X	X	X	X	X	X	X	X	X	X
20	X	X	X	X	X	X	X	X	X	X	X	X
22	X	X	X	X	X	X	X	X	X	X	X	X
24	X	X	X	X	X	X	X	X	X	X	X	X
26	X	X	X	X	X	X	X	X	X	X	X	X
28	X	X	X	X	X	X	X	X	X	X	X	X
30	X	X	X	X	X	X	X	X	X	X	X	X
32	X	X	X	X	X	X	X	X	X	X	X	X
34	X	X	X	X	X	X	X	X	X	X	X	X
36	X	X	X	X	X	X	X	X	X	X	X	X
38	X	X	X	X	X	X	X	X	X	X	X	X
40	X	X	X	X	X	X	X	X	X	X	X	X
42	X	X	X	X	X	X	X	X	X	X	X	X
44	X	X	X	X	X	X	X	X	X	X	X	X
46	X	X	X	X	X	X	X	X	X	X	X	X
48	X	X	X	X	X	X	X	X	X	X	X	X

Available Finishes		Available Accessories	
Standard		XG-OB	Steel Opposed Blade Damper
01	White	XG-OBDA	Aluminum Opposed Blade Damper
Optional		XG-PF	Plaster Frame
02	Satin Silver	IS	Insect Screen
03	Black		
04	Clear Anodized		
24	Mill		
28	Custom Color		

**XG-HDRH MODEL NUMBER SPECIFICATIONS
HEAVY DUTY RETURN**

Model		Neck										
XG-HDRH-1	Aluminum Surface Mount	28	30	32	34	36	38	40	42	44	46	48
4	X	X	X	X	X	X	X	X	X	X	X	X
5	X	X	X	X	X	X	X	X	X	X	X	X
6	X	X	X	X	X	X	X	X	X	X	X	X
8	X	X	X	X	X	X	X	X	X	X	X	X
10	X	X	X	X	X	X	X	X	X	X	X	X
12	X	X	X	X	X	X	X	X	X	X	X	X
14	X	X	X	X	X	X	X	X	X	X	X	X
16	X	X	X	X	X	X	X	X	X	X	X	X
18	X	X	X	X	X	X	X	X	X	X	X	X
20	X	X	X	X	X	X	X	X	X	X	X	X
22	X	X	X	X	X	X	X	X	X	X	X	X
24	X	X	X	X	X	X	X	X	X	X	X	X
26	X	X	X	X	X	X	X	X	X	X	X	X
28	X	X	X	X	X	X	X	X	X	X	X	X
30	X	X	X	X	X	X	X	X	X	X	X	X
32	X	X	X	X	X	X	X	X	X	X	X	X
34	X	X	X	X	X	X	X	X	X	X	X	X
36	X	X	X	X	X	X	X	X	X	X	X	X
38	X	X	X	X	X	X	X	X	X	X	X	X
40	X	X	X	X	X	X	X	X	X	X	X	X
42	X	X	X	X	X	X	X	X	X	X	X	X
44	X	X	X	X	X	X	X	X	X	X	X	X
46	X	X	X	X	X	X	X	X	X	X	X	X
48	X	X	X	X	X	X	X	X	X	X	X	X

Available Finishes		Available Accessories	
Standard		XG-OBD	Steel Opposed Blade Damper
01	White	XG-OBDA	Aluminum Opposed Blade Damper
Optional		XG-PF	Plaster Frame
02	Satin Silver	IS	Insect Screen
03	Black		
04	Clear Anodized		
24	Mill		
28	Custom Color		

SERIES XG-HDRH PERFORMANCE DATA
MODEL XG-HDRH

Size	Duct Area ft ²	Nk Vel	200	300	400	500	600	700	800	1000	1200
		Ps	-.002	-.005	-.009	-.014	-.020	-.027	-.036	-.056	-.080
06x06	.25	CFM	50	75	100	125	150	175	200	250	300
		NC	-	12	14	15	17	19	20	24	27
08x06	.33	CFM	67	100	133	167	200	233	267	333	400
		NC	12	13	15	17	18	20	22	25	28
08x08	.44	CFM	89	133	178	222	267	311	356	444	533
		NC	13	15	16	18	20	21	23	26	30
12x06	.50	CFM	100	150	200	250	300	350	400	500	600
		NC	13	15	17	18	20	22	23	27	30
16x06 12x08	.67	CFM	133	200	267	333	400	467	533	667	800
		NC	15	16	18	20	21	23	25	28	31
12x10	.83	CFM	167	250	333	417	500	583	667	833	1000
		NC	16	17	19	21	22	24	26	29	32
24x06 12x12	1.00	CFM	200	300	400	500	600	700	800	1000	1200
		NC	16	18	20	21	23	25	26	30	33
14x12	1.16	CFM	233	350	467	583	700	817	933	1167	1400
		NC	17	19	20	22	24	25	27	30	34
14x14	1.36	CFM	272	408	544	681	817	953	1089	1361	1633
		NC	18	19	21	23	24	26	28	31	34
18x18	2.25	CFM	450	675	900	1125	1350	1575	1800	2250	2700
		NC	20	22	23	25	27	28	30	33	37
24x12 18x16	2.00	CFM	400	600	800	1000	1200	1400	1600	2000	2400
		NC	19	21	23	24	26	28	29	33	36
24x18	3.00	CFM	600	900	1200	1500	1800	2100	2400	3000	3600
		NC	21	23	24	26	28	30	31	35	38
48x12 24x24	4.00	CFM	800	1200	1600	2000	2400	2800	3200	4000	4800
		NC	22	24	26	27	29	31	32	36	39
30x20	4.17	CFM	833	1250	1667	2083	2500	2917	3333	4167	5000
		NC	23	24	26	28	29	31	33	36	39
36x20 30x24	5.00	CFM	1000	1500	2000	2500	3000	3500	4000	5000	6000
		NC	23	25	27	28	30	32	33	37	40
36x22	5.50	CFM	1100	1650	2200	2750	3300	3850	4400	5500	6600
		NC	24	25	27	29	30	32	34	37	41

CONTINUED

SERIES XG-HDRH PERFORMANCE DATA
MODEL XG-HDRH

Size	Duct Area ft ²	Nk Vel	200	300	400	500	600	700	800	1000	1200
		Ps	-0.02	-0.05	-0.09	-0.14	-0.20	-0.27	-0.36	-0.56	-0.80
48x18 36x24	6.00	CFM	1200	1800	2400	3000	3600	4200	4800	6000	7200
		NC	24	26	28	29	31	33	34	38	41
48x24 36x32	8.00	CFM	1600	2400	3200	4000	4800	5600	6400	8000	9600
		NC	25	27	29	30	32	34	35	39	42
48x30 42x34	10.00	CFM	2000	3000	4000	5000	6000	7000	8000	10000	-
		NC	26	28	30	31	33	35	36	40	-
48x36	12.00	CFM	2400	3600	4800	6000	7200	8400	9600	-	-
		NC	27	29	31	32	34	36	37	-	-
48x40	13.33	CFM	2667	4000	5333	6667	8000	9333	-	-	-
		NC	28	29	31	33	34	36	-	-	-
48x48	16.00	CFM	3200	4800	6400	8000	9600	-	-	-	-
		NC	28	30	32	33	35	-	-	-	-

PERFORMANCE NOTES FOR SERIES XG-HDRH

All data is tested in accordance with ANSI/ASHRAE 70-2006.

DEFINITION OF UNITS

CFM Cubic Feet per Minute (air)

Nk Vel Neck Velocity of air stream in Feet per Minute

Ps Negative Static pressure (inches of water column)

NC Noise criterion, Sound pressure level. NC ratings are based on sound power level (Lw)

RE: 10^{-12} watts minus a 10dB room attenuation in all octave bands.

MODEL XG-4500

XG-4500 – 0° deflection XG-4538 – 38° deflection

Air Inlets shall be model XG-4500 (0° deflection) or XG-4538 (38° deflection) manufactured by GREENHECK. Units shall be return or exhaust grilles constructed of 14 gauge deflector blades and 16 gauge borders. Outlets shall be designed to withstand moderate physical abuse. The units shall be the size and quantity as outlined in the plans and specifications.

Border shall be 1 1/4" wide with aerodynamically shaped deflector blades on .666" centers. Deflector blades shall be fixed. Units shall be designed for surface mounting applications and be provided with counter sunk screw holes on the face of the device.

Damper Accessories (Optional)

Optional opposed blade damper shall be constructed of steel (Model XG-OBD) or aluminum (Model XG-OBDA). Damper must be operable from the face of the diffuser

Performance Specification

The manufacturer shall provide published performance data. Data shall be tested in accordance to ANSI/ASHRAE Standard 70- 2006



Model: XG-4500-1 (0° Deflection Grille - Surface Mount - Horizontal Fixed Blades)

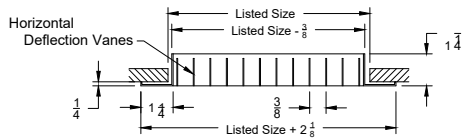

Model: XG-4538-1 (38° Deflection Grille - Surface Mount - Horizontal Fixed Blades)

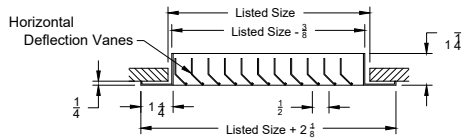

Model: XG-4500-1 (0° Deflection Register) with Opposed Blade Damper

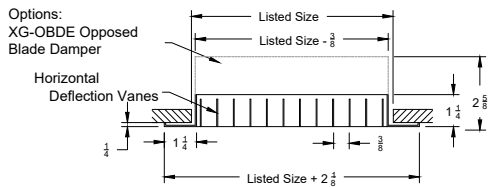

Face view (Models: XG-4500-1 & XG-4538-1)

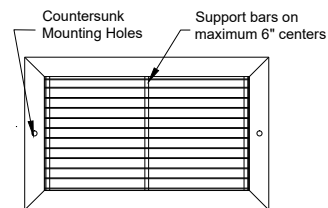

Model: XG-4500-1 (38° Deflection Register)

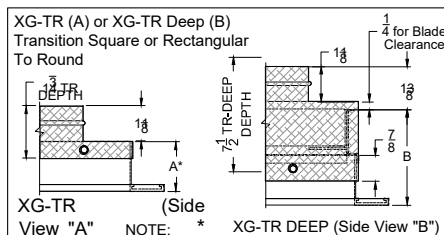
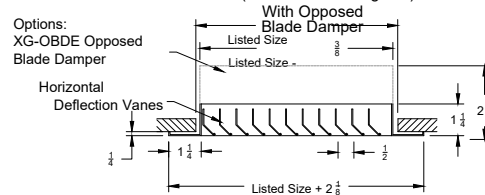

**SERIES XG-4500 MODEL NUMBER SPECIFICATION
HEAVY DUTY GYM GRILLE — STEEL — SURFACE MOUNT**

Model		Neck											
XG-4500	0° Deflection		6	8	10	12	14	16	18	20	22	24	26
XG-4538	38° Deflection	4	X	X	X	X	X	X	X	X	X	X	X
		5	X	X	X	X	X	X	X	X	X	X	X
		6	X	X	X	X	X	X	X	X	X	X	X
		8	X	X	X	X	X	X	X	X	X	X	X
		10	X	X	X	X	X	X	X	X	X	X	X
		12	X	X	X	X	X	X	X	X	X	X	X
		14	X	X	X	X	X	X	X	X	X	X	X
		16	X	X	X	X	X	X	X	X	X	X	X
		18	X	X	X	X	X	X	X	X	X	X	X
		20	X	X	X	X	X	X	X	X	X	X	X
		22	X	X	X	X	X	X	X	X	X	X	X
		24	X	X	X	X	X	X	X	X	X	X	X
		26	X	X	X	X	X	X	X	X	X	X	X
		28	X	X	X	X	X	X	X	X	X	X	X
		30	X	X	X	X	X	X	X	X	X	X	X
		32	X	X	X	X	X	X	X	X	X	X	X
		34	X	X	X	X	X	X	X	X	X	X	X
		36	X	X	X	X	X	X	X	X	X	X	X
		38	X	X	X	X	X	X	X	X	X	X	X
		40	X	X	X	X	X	X	X	X	X	X	X
		42	X	X	X	X	X	X	X	X	X	X	X
		44	X	X	X	X	X	X	X	X	X	X	X
		46	X	X	X	X	X	X	X	X	X	X	X
		48	X	X	X	X	X	X	X	X	X	X	X

Available Finishes		Available Accessories	
Standard		XG-OBDA	Aluminum Opposed Blade Damper
01	White	XG-L9	Equalizing Grid
Optional		XG-PF	Plaster Frame
02	Satin Silver	IS	Insect Screen
03	Black	XG-TR	Square to Round Transition
28	Custom Color	XG-TR Deep	Deep Square to Round Transition

Available Options	
NSH	No Screw Holes
CM	Concealed Mounting

SERIES XG-4500 MODEL NUMBER SPECIFICATION
HEAVY DUTY GYM GRILLE — STEEL — SURFACE MOUNT

Model		Neck											
XG-4500	0° Deflection		28	30	32	34	36	38	40	42	44	46	48
XG-4538	38° Deflection	4	X	X	X	X	X	X	X	X	X	X	X
		5	X	X	X	X	X	X	X	X	X	X	X
		6	X	X	X	X	X	X	X	X	X	X	X
		8	X	X	X	X	X	X	X	X	X	X	X
		10	X	X	X	X	X	X	X	X	X	X	X
		12	X	X	X	X	X	X	X	X	X	X	X
		14	X	X	X	X	X	X	X	X	X	X	X
		16	X	X	X	X	X	X	X	X	X	X	X
		18	X	X	X	X	X	X	X	X	X	X	X
		20	X	X	X	X	X	X	X	X	X	X	X
		22	X	X	X	X	X	X	X	X	X	X	X
		24	X	X	X	X	X	X	X	X	X	X	X
		26	X	X	X	X	X	X	X	X	X	X	X
		28	X	X	X	X	X	X	X	X	X	X	X
		30	X	X	X	X	X	X	X	X	X	X	X
		32	X	X	X	X	X	X	X	X	X	X	X
		34	X	X	X	X	X	X	X	X	X	X	X
		36	X	X	X	X	X	X	X	X	X	X	X
		38	X	X	X	X	X	X	X	X	X	X	X
		40	X	X	X	X	X	X	X	X	X	X	X
		42	X	X	X	X	X	X	X	X	X	X	X
		44	X	X	X	X	X	X	X	X	X	X	X
		46	X	X	X	X	X	X	X	X	X	X	X
		48	X	X	X	X	X	X	X	X	X	X	X

Available Finishes		Available Accessories	
Standard		XG-OBDA	Aluminum Opposed Blade Damper
01	White	XG-L9	Equalizing Grid
Optional		XG-PF	Plaster Frame
02	Satin Silver	IS	Insect Screen
03	Black	XG-TR	Square to Round Transition
28	Custom Color	XG-TR Deep	Deep Square to Round Transition

Available Options	
NSH	No Screw Holes
CM	Concealed Mounting

SERIES XG-4500 PERFORMANCE DATA
MODEL XG-4500

Size	Duct Area ft ²	Nk Vel	300	400	500	600	700	800	900	1000	1200
		Ps	-.012	-.022	-.034	-.049	-.067	-.087	-.110	-.136	-.196
06x06	.25	CFM	63	84	105	126	147	168	189	210	252
		NC	-	-	-	-	20	22	27	28	32
08x06	.33	CFM	86	115	143	172	201	229	258	286	344
		NC	-	-	-	-	21	23	28	29	33
08x08	.44	CFM	117	156	195	234	273	313	352	391	469
		NC	-	-	-	-	26	25	30	31	35
12x06	.50	CFM	132	176	220	264	307	351	395	439	527
		NC	-	-	-	-	23	25	30	31	35
16x06 12x08	.67	CFM	180	240	299	359	419	479	539	599	719
		NC	-	-	-	21	25	27	32	33	37
12x10	.83	CFM	228	303	379	455	531	607	683	759	910
		NC	-	-	-	22	26	28	33	34	38
24x06 12x12	1.00	CFM	276	367	459	551	643	735	827	918	1102
		NC	-	-	-	22	26	28	33	34	38
14x12	1.16	CFM	323	431	539	647	755	863	970	1078	1294
		NC	-	-	20	23	27	29	34	35	39
14x14	1.36	CFM	380	506	633	759	886	1013	1139	1139	1524
		NC	-	-	21	24	28	30	35	36	40
18x18	2.25	CFM	638	851	1063	1276	1489	1701	1914	2127	2552
		NC	-	21	23	26	30	32	37	38	42
24x12 18x16	2.00	CFM	563	751	938	1126	1314	1501	1689	1877	2252
		NC	-	20	22	25	29	31	36	37	41
24x18	3.00	CFM	857	1142	1428	1714	1999	2285	2570	2856	3427
		NC	-	22	24	27	31	33	38	39	43
48x12 24x24	4.00	CFM	1151	1534	1918	2301	2685	3068	3452	3835	4602
		NC	21	24	26	29	33	35	40	41	45
30x20	4.17	CFM	1198	1598	1997	2397	2797	3196	3595	3995	4794
		NC	21	24	26	29	33	35	40	41	45
36x20 30x24	5.00	CFM	1444	1926	2407	2889	3370	3851	4333	4814	5777
		NC	22	25	27	30	34	36	41	42	46
36x22	5.50	CFM	1590	2120	2650	3180	3710	4240	4770	5300	6360
		NC	22	25	27	30	34	36	41	42	46
48x18 36x24	6.00	CFM	1738	2317	2897	3476	4055	4635	5214	5793	6952
		NC	22	25	27	30	34	36	41	42	46
48x24 36x32	8.00	CFM	2326	3101	3876	4651	5426	6201	6977	7752	9302
		NC	24	27	29	32	36	38	43	44	48
48x30 42x34	10.00	CFM	2919	3892	4865	5839	6812	7785	8758	9731	11677
		NC	25	28	30	33	37	39	44	45	49

CONTINUED

SERIES XG-4500 PERFORMANCE DATA
MODEL XG-4500

Size	Duct Area ft ²	Nk Vel	300	400	500	600	700	800	900	1000	1200
		Ps	-.012	-.022	-.034	-.049	-.067	-.087	-.110	-.136	-.196
48x36	12.00	CFM	3513	4684	5855	7026	8197	9368	10539	11710	14052
		NC	25	28	30	33	37	39	44	45	49
48x40	13.33	CFM	3909	5212	6515	7818	9121	10424	11727	13030	15635
		NC	26	29	31	24	28	40	45	46	50
48x48	16.00	CFM	4701	6267	7837	9401	10968	12535	14102	15668	18802
		NC	27	30	32	35	39	41	46	47	51

PERFORMANCE NOTES FOR SERIES XG-4500

All data is tested in accordance with ANSI/ASHRAE 70-2006.

DEFINITION OF UNITS

CFM Cubic Feet per Minute (air)

Nk Vel Neck Velocity of air stream in Feet per Minute

Ps Negative Static pressure (inches of water column)

NC Noise criterion, Sound pressure level. NC ratings are based on sound power level (Lw)

RE: 10⁻¹² watts minus a 10dB room attenuation in all octave bands.

SERIES XG-4500 PERFORMANCE DATA
MODEL XG-4538

Size	Duct Area ft ²	Nk Vel	300	400	500	600	700	800	900	1000	1200
		Ps	-.012	-.022	-.034	-.049	-.067	-.087	-.110	-.136	-.196
06x06	.25	CFM	63	84	105	126	147	168	189	210	252
		NC	-	-	-	-	23	27	32	37	48
08x06	.33	CFM	86	115	143	172	201	229	258	286	344
		NC	-	-	-	-	24	28	33	38	49
08x08	.44	CFM	117	156	195	234	273	313	352	391	469
		NC	-	-	-	21	26	30	35	40	51
12x06	.50	CFM	132	176	220	264	307	351	395	439	527
		NC	-	-	-	21	26	30	35	40	51
16x06 12x08	.67	CFM	180	240	299	359	419	479	539	599	719
		NC	-	-	-	23	28	28	37	42	53
12x10	.83	CFM	228	303	379	455	531	607	683	759	910
		NC	-	-	20	24	29	33	38	43	54
24x06 12x12	1.00	CFM	276	367	459	551	643	735	827	918	1102
		NC	-	-	20	24	29	33	38	43	54
14x12	1.16	CFM	323	431	539	647	755	863	970	1078	1294
		NC	-	-	21	25	30	34	39	44	55
14x14	1.36	CFM	380	506	633	759	886	1013	1139	1139	1524
		NC	-	-	22	26	31	35	40	40	48
18x18	2.25	CFM	638	851	1063	1276	1489	1701	1914	2127	2552
		NC	-	20	24	28	33	37	42	47	58
24x12 18x16	2.00	CFM	563	751	938	1126	1314	1501	1689	1877	2252
		NC	-	19	23	27	32	36	41	46	57
24x18	3.00	CFM	857	1142	1428	1714	1999	2285	2570	2856	3427
		NC	-	21	25	29	34	38	43	48	59
48x12 24x24	4.00	CFM	1151	1534	1918	2301	2685	3068	3452	3835	4602
		NC	20	23	27	31	36	40	45	50	61
30x20	4.17	CFM	1198	1598	1997	2397	2797	3196	3595	3995	4794
		NC	20	23	27	27	31	36	45	50	61
36x20 30x24	5.00	CFM	1444	1926	2407	2889	3370	3851	4333	4814	5777
		NC	21	24	28	32	37	41	46	51	62
36x22	5.50	CFM	1738	2317	2897	3476	4055	4635	5214	5793	6952
		NC	21	24	28	32	37	41	46	51	62
48x18 36x24	6.00	CFM	2205	2940	3674	4409	5144	5879	6614	7349	8819
		NC	22	25	29	33	38	42	47	52	63
48x24 36x32	8.00	CFM	2326	3101	3876	4651	5426	6201	6977	7752	9302
		NC	23	26	30	34	39	43	48	53	64

CONTINUED

SERIES XG-4500 PERFORMANCE DATA
MODEL XG-4538

Size	Duct Area ft ²	Nk Vel	300	400	500	600	700	800	900	1000	1200
		Ps	-.012	-.022	-.034	-.049	-.067	-.087	-.110	-.136	-.196
48x30 42x34	10.00	CFM	2919	3892	4865	5839	6812	7785	8758	9731	11677
		NC	24	27	31	35	40	44	49	54	65
48x36	12.00	CFM	3513	4684	5855	7026	8197	9368	10539	11710	14052
		NC	24	27	31	35	40	44	49	54	65
48x40	13.33	CFM	3909	5212	6515	7818	9121	10424	11727	13030	15635
		NC	25	28	32	36	41	45	50	55	66
48x48	16.00	CFM	4701	6267	7834	9401	10968	12535	14102	15668	18802
		NC	26	29	33	37	42	46	51	56	67

PERFORMANCE NOTES FOR SERIES XG-4500

All data is tested in accordance with ANSI/ASHRAE 70-2006.

DEFINITION OF UNITS

CFM Cubic Feet per Minute (air)

Nk Vel Neck Velocity of air stream in Feet per Minute

Ps Negative Static pressure (inches of water column)

NC Noise criterion, Sound pressure level. NC ratings are based on sound power level (Lw)

RE: 10⁻¹² watts minus a 10dB room attenuation in all octave bands.

DOOR/TRANSFER GRILLES



GREENHECK offers a complete line of aluminum door grilles in a variety of mounting styles to suit every application.

Aluminum Door Grille

The XG-DG series of door and transfer grilles is available in aluminum construction and is designed for the transfer of air through doors or walls, or as a vision proof return. All models include V-shape louvers providing a sight-proof return or exhaust grille regardless of the viewing angle.

- XG-DGCO – Core only – Recessed appearance
- XG-DGSF – Single flange – Finished appearance on only one side of the door or wall
- XG-DGDF – Double flange – Finished appearance on both sides of the door or wall
- XG-DGLP – Light resistant – Double core construction

PAGE 146

MODEL XG-DG



Door Grille - Core Only - Extruded Aluminum/Model XG-DGCO

Air Inlets shall be series XG-DGCO manufactured by GREENHECK. Units shall be return or exhaust grilles designed to transfer air through doors or walls. Units shall be of extruded aluminum construction and with an extruded aluminum border and a single set of 1" inverted "V" louvers. The units shall be the size and quantity as outlined in the plans and specifications.

Inlets shall have a narrow border providing a recessed appearance when installed. Louvers shall be on .666" centers set at 70° and overlapped to provide a vision proof effect.

Deflector blades shall be fixed. Units shall be designed to integrate into a wall or door application.

Door Grille - Surface Mount - Single Frame Flange - Extruded Aluminum/Model XG-DGSF

Air Inlets shall be series XG-DGSF manufactured by GREENHECK. Units shall be return or exhaust grilles designed to transfer air through doors or walls. Units shall be of extruded aluminum construction and with an extruded aluminum border and a single set of 1" inverted "V" louvers. The units shall be the size and quantity as outlined in the plans and specifications.

Inlets shall have a single 1 1/4" border with screw holes for surface mounting. Units to provide a finished appearance on one side of the door. Louvers shall be on .666" centers set at 70° and overlapped to provide a vision proof effect.

Deflector blades shall be fixed. Units shall be designed to integrate into a wall or door application.

Door Grille - Surface Mount - Double Frame Flange - Telescoping - Extruded Aluminum/Model XG-DGDF

Air Inlets shall be series XG-DGDF manufactured by GREENHECK. Units shall be return or exhaust grilles designed to transfer air through doors or walls. Units shall be of extruded aluminum construction and with an extruded aluminum border and a single set of 1" inverted "V" louvers. The units shall be the size and quantity as outlined in the plans and specifications.

Inlets shall have a single 1 1/4" border and a telescoping rear frame to fit varying door thickness providing a finished appearance on both sides of the door or wall. Units shall include screw holes for surface mounting. Louvers shall be on .666" centers set at 70° and overlapped to provide a vision proof effect.

Deflector blades shall be fixed. Units shall be designed to integrate into a wall or door application.

Door Grille - Surface Mount - Double Frame Flange - Light Resistant - Extruded Aluminum/Model XG-DGLP

Air Inlets shall be series XG-DGLP manufactured by GREENHECK. Units shall be return or exhaust grilles designed to transfer air through doors or walls. Units shall be of extruded aluminum construction and with an extruded aluminum border and a two sets of 1" inverted "V" louvers. The units shall be the size and quantity as outlined in the plans and specifications.

Inlets shall have a single 1 1/4" border with screw holes for surface mounting. Units to provide a finished appearance on one side of the door. Louvers shall be on .666" centers set at 70° and overlapped to provide a minimum light transmission.

Deflector blades shall be fixed. Units shall be designed to integrate into a wall or door application.

Performance Specification

The manufacturer shall provide published performance data. Data shall be tested in accordance to ANSI/ASHRAE Standard 70- 2006.

MODEL XG-DG

Model : **XG-DGCO** (Door / Transfer Grille - Core Only)

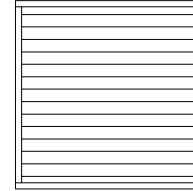
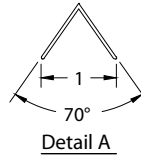
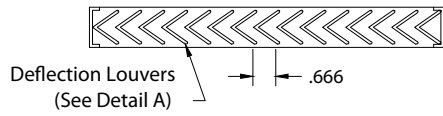

Face View
(Model XG-DGCO)

Model : **XG-DGSF** (Door / Transfer Grille - Single Flange Frame)

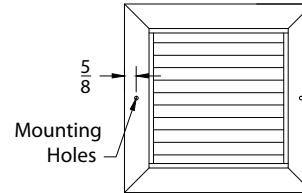
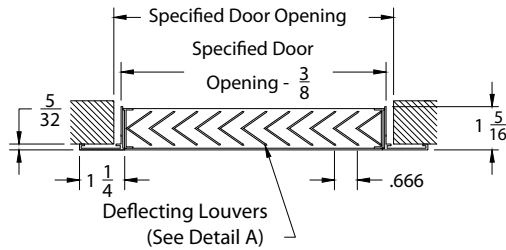

Face View
(Model XG-DGSF)

Model : **XG-DGDF** (Door / Transfer Grille - Double Flange Frame)

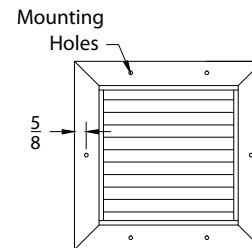
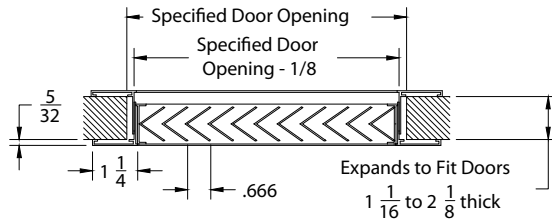

Face View
(Models: XG-DGDF &
XG-DGLP)

Model : **XG-DGLP** (Door / Transfer Grille - Light Resistant)

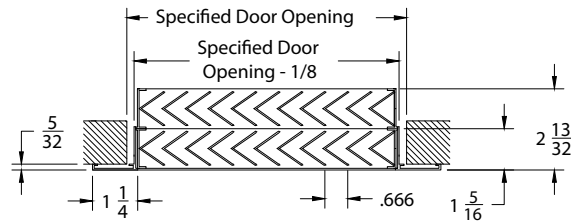

XG-DG MODEL NUMBER SPECIFICATION

Model #	Width	Height	Available Finishes		Available Options
XG-DGCO	6 - 48 (Single Section)	6 - 36 (Single Section)	01	White	Odd Size (Width Only)
XG-DGSF			02	Satin Silver	Fractional Size (Width Only)
XG-DGDF			03	Black	
XG-DGLP			24	Mill	
			28	Custom Color	

SERIES XG-DG PERFORMANCE DATA
MODELS XG-DGSF, XG-DGDF

Size	Velocity	200	300	400	500	600	700	800	900	1000
	Ps	.024	.055	.097	.151	.218	.297	.388	.491	.606
6 x 6	CFM	50	75	100	125	150	175	200	225	250
	NC	<15	19	23	26	29	32	34	37	39
8 x 6	CFM	67	100	133	167	200	233	267	300	333
	NC	16	20	24	27	30	33	36	38	40
8 x 8	CFM	89	133	178	222	267	311	356	400	444
	NC	17	22	25	29	32	34	37	39	42
10 x 6	CFM	83	125	167	208	250	292	333	375	417
	NC	17	21	25	28	31	34	37	39	41
10 x 8	CFM	111	167	222	278	333	389	444	500	556
	NC	18	23	26	30	32	35	38	40	43
10 x 10	CFM	139	208	278	347	417	486	556	625	694
	NC	19	24	27	30	33	36	39	41	44
12 x 10	CFM	1678	250	333	417	500	583	667	750	833
	NC	20	24	28	31	34	37	40	42	44
12 x 12	CFM	200	300	400	500	600	700	800	900	1000
	NC	21	25	29	32	35	38	40	43	45
14 x 12	CFM	233	350	467	583	700	817	933	1050	1167
	NC	21	26	29	33	36	38	41	43	46
14 x 14	CFM	272	408	544	681	817	953	1089	1225	1361
	NC	22	26	30	33	36	39	42	44	46
16 x 12	CFM	267	400	533	667	800	933	1067	1200	1333
	NC	22	26	30	33	36	39	42	44	46
16 x 16	CFM	356	533	711	889	1067	1244	1422	1600	1778
	NC	23	28	31	35	38	40	43	45	48
18 x 12	CFM	300	450	600	750	900	1050	1200	1350	1500
	NC	23	27	31	34	37	40	42	45	47
18 x 18	CFM	450	675	900	1125	1350	1575	1800	2025	2250
	NC	24	29	32	36	39	41	44	46	49
20 x 12	CFM	333	500	667	833	1000	1167	1333	1500	1667
	NC	23	27	31	34	37	40	43	45	47
20 x 20	CFM	556	833	1111	1389	1667	1944	2222	2500	2778
	NC	25	30	33	36	39	42	45	47	50
24 x 12	CFM	400	600	800	1000	1200	1400	1600	1800	2000
	NC	24	28	32	35	38	41	43	46	48
24 x 18	CFM	600	900	1200	1500	1800	2100	2400	2700	3000
	NC	26	30	34	37	40	43	45	48	50
24 x 24	CFM	800	1200	1600	2000	2400	2800	3200	3600	4000
	NC	27	31	35	38	41	44	46	49	51
30 x 12	CFM	500	750	1000	1250	1500	1750	2000	2250	2500
	NC	25	29	33	36	39	42	44	47	49
30 x 20	CFM	833	1250	1667	2083	2500	2917	3333	3750	4167
	NC	27	31	35	38	41	44	47	49	51
30 x 24	CFM	1000	1500	2000	2500	3000	3500	4000	4500	5000
	NC	28	32	36	39	42	45	47	50	52
30 x 30	CFM	1250	1875	2500	3125	3750	4375	5000	5625	6250
	NC	29	33	37	40	43	46	48	51	53
	Throw	N/A	N/A	N/A	N/A	N/A	N/A	N/A	N/A	N/A

PERFORMANCE NOTES FOR SERIES XG-DG

All data is tested in accordance with ANSI/ASHRAE 70-2006.

DEFINITION OF UNITS

P_s Static pressure = $P_t - P_v$ (inches of water column)

NC Noise criterion, sound pressure level NC ratings are based on sound power level (L_w) re: 10^{-12} watts minus a 10dB room attenuation in all octave bands

Throw Non-isothermal horizontal throw (supply air temperature 15°F colder than average room temperature); values are for 150, 100 and 50fpm velocities

Velocity fpm (Feet per Minute)

CFM Cubic Feet per Minute (Air)

INDUSTRIAL GRILLES

MODEL XG-4100

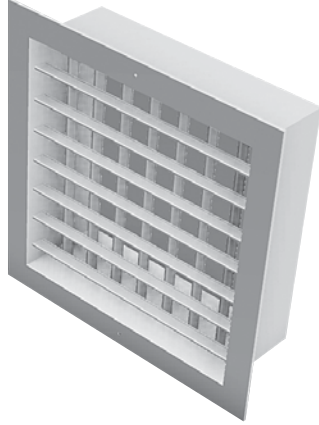

MODEL XG-4200

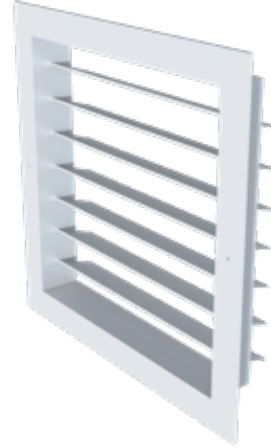

MODEL XG-4300



MODEL XG-RL



Greenheck offers a complete line of industrial grilles for applications that require specialized performance or construction characteristics.

Aluminum Multi-Core Supply Grilles 4 3/8"
Deep Frame – 1 1/2" Blades on 1 1/2" Center

The XG-4100 series of industrial grilles is designed for high capacity air distribution in an industrial environment. The series is designed for ceiling and high sidewall installation.

- XG-4152 – Single deflection
- XG-4152IF – Single deflection – Inverted frame
- XG-4152TLF – Single deflection – Trunk latch frame
- XG-4152MF – Single deflection – Modular frame
- XG-4154 – Double deflection
- XG-4154IF – Double deflection – Inverted frame
- XG-4154TLF – Double deflection – Trunk latch frame
- XG-4154MF – Double deflection – Modular frame

PAGE 154

PAGE 156

Aluminum Multi-Core Supply Grilles 1 7/8"**Shallow Frame 1 1/2" Blades on 1 1/2" Center**

The XG-4200 series of industrial grilles is designed for high capacity air distribution in an industrial environment. The shallow frame permits deflectors to project past the frame for a greater deflection angle.

- XG-4252 – Single deflection
- XG-4252IF – Single deflection – Inverted frame
- XG-4252TLF – Single deflection - Trunk latch frame
- XG-4252MF – Single Deflection – Modular frame
- XG-4254 – Double deflection
- XG-4254IF – Double deflection - Inverted frame
- XG-4254TLF – Double deflection - Trunk latch frame
- XG-4254MF – Double deflection – Modular frame

PAGE 158

Aluminum Multi-Core Supply Grilles 7"**Deep Frame – 3" Blades on 3" Center**

The XG-4300 series of industrial grilles is designed for high capacity air distribution in an industrial environment. The wider blade spacing offers superior control of large volumes of air and minimum pressure drop.

- XG-4352 – Single deflection
- XG-4352MF – Single deflection – Modular frame
- XG-4354 – Double deflection
- XG-4354MF – Double deflection – Modular frame

PAGE 161

Aluminum Roto Louver Supply

The XG-RL series roto louver is designed to provide jet or diffused air patterns in ceiling, sidewall and exposed duct applications. The RL series is ideal for vertical spot cooling or heating when mounted in the ceiling or on the bottom of exposed ductwork.

- XG-RL – Cylindrical drum – Standard blades
- XG-RLDF – Cylindrical drum – Dual flow blades
- XG-RLG0 – Cylindrical drum – Standard blades – Gang operator

PAGE 185

MODEL XG-4100/ XG-4200/XG-4300

Supply - Single Deflection Supply Grilles and Registers – Aluminum/Series

XG-4152 – 4 3/8” deep collars with 1 1/2” blades on 1 1/2” centers

XG-4252 – 1 7/8” deep collars with 1 1/2” blades on 1 1/2” centers

XG-4352 – 7” deep collars with 3” blades on 3” centers

Air Outlets shall be model XG-V4152, XG-V4252, or XG-V4352 with vertical front blades or XG-H4152, XG-H4252, or XG-H4352 with horizontal front blades manufactured by GREENHECK. Units shall be single deflection supply grilles of extruded aluminum construction.

Options

Outlets shall have 4 3/8” deep collars with 1 1/2” blades on 1 1/2” centers

Outlets shall have 1 7/8” deep collars with 1 1/2” blades on 1 1/2” centers

Outlets shall have 7” deep collars with 3” blades on 3” centers

Options

Units shall include an Inverted Frame Units shall include a Trunk Latch

Frame Units shall include a Modular Frame.

The units shall be the size and quantity as outlined in the plans and specifications.

Border shall be 1 1/2” wide with individually adjustable, aerodynamically shaped deflector blades. Units shall be designed for surface mounting applications and be provided with screw holes on the face of the device.

Blades shall pivot in friction mounting retainers. Retainers shall hold the deflector blade position throughout the specified operating range of the device. Metal friction wires are not acceptable.

Optional Damper

Optional opposed blade damper shall be constructed of steel (model XG-OBD) or aluminum (model XG-OBDA). Damper must be operable from the face of the diffuser.

Supply - Double Deflection Supply Grilles and Registers – Aluminum/Series

XG-4154 – 4 3/8” deep collars with 1 1/2” blades on 1 1/2” centers

XG-4254 – 1 7/8” deep collars with 1 1/2” blades on 1 1/2” centers

XG-4354 – 7” deep collars with 3” blades on 3” centers

Air Outlets shall be model XG-V4154, XG-V4254, or XG-V4354 with vertical front blades or XG-H4154, XG-H4254, or XG-H4354 with horizontal front blades manufactured by GREENHECK. Units shall be single deflection supply grilles with front and rear sets of deflection extruded aluminum blades.

Options

Outlets shall have 4 3/8” deep collars with 1 1/2” blades on 1 1/2” centers Outlets shall have 1 7/8” deep collars with 1 1/2” blades on 1 1/2” centers Outlets shall have 7” deep collars with 3” blades on 3” centers.

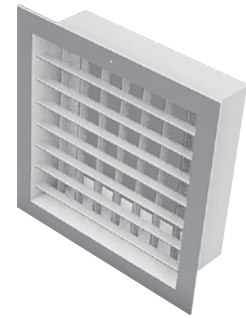

MODEL XG-4100

Modular Frame Industrial Grille Extruded Aluminum

Models: **XG-V4152MF XG-H4152MF** Single Deflection Grille - Vertical / Horizontal Blades - 4 3/8" Frame Deep
XG-V4252MF XG-H4252MF Single Deflection Grille - Vertical / Horizontal Blades - 1 7/8" Narrow Frame Deep
XG-V4352MF XG-H4352MF Single Deflection Grille - Vertical / Horizontal Blades - 7" Frame Deep
XG-V4154MF XG-H4154MF Double Deflection Grille - Vertical / Horizontal Front Blades - 4 3/8" Frame Deep
XG-V4254MF XG-H4254MF Double Deflection Grille - Vertical / Horizontal Blades - 1 7/8" Narrow Frame Deep
XG-V4354MF XG-H4354MF Double Deflection Grille - Vertical / Horizontal Blades - 7" Frame Deep

Models: XG-4152MF / XG-4252MF / XG-4352MF / XG-4154MF / XG-4254MF / XG-4354MF - V or H Blades (1-1 Core Unit)

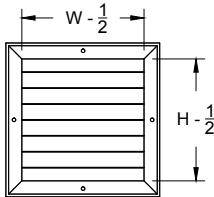

H (Duct Listed Size)	Duct Dimension W			
	Module 1	Module 2	Module 3	Module 4
8	8	19	30	41
10	10	23	36	49
12	12	27	42	57
15	15	33	51	69

Models: XG-4152MF / XG-4252MF / XG-4352MF / XG-4154MF / XG-4254MF / XG-4354MF - V or H Blades (2-2 Core Unit)

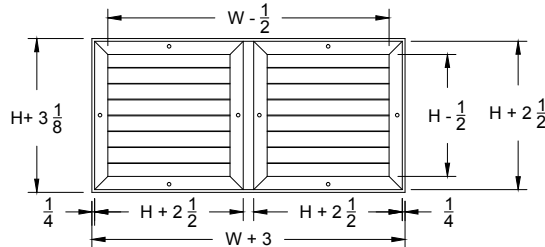

Models: XG-4152MF / XG-4252MF / XG-4352MF / XG-4154MF / XG-4254MF / XG-4354MF - V or H Blades (3-3 Core Unit)

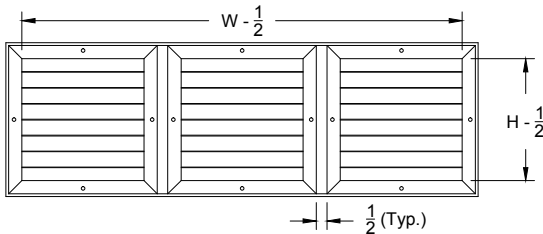

Models: XG-4152MF / XG-4252MF / XG-4352MF / XG-4154MF / XG-4254MF / XG-4354MF - V or H Blades (4-4 Core Unit)

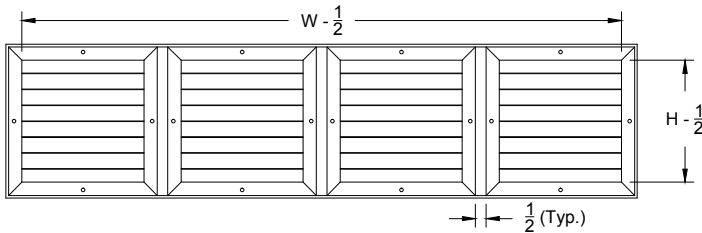

MODEL XG-4152

Sidewall Industrial Supply Grilles / Registers - Single Deflection Aluminum - 4 3/8" Frame Depth - 1 1/2" Blade Spacing

- Models **XG-V4152** Single Deflection Grille - Vertical Blades
 XG-H4152 Single Deflection Grille - Horizontal Blades
 XG-V4152 IF Single Deflection Grille - Vertical Blades - Inverted Frame
 XG-H4152 IF Single Deflection Grille - Horizontal Blades - Inverted Frame

Model: XG-H4152 / XG-V4152 (Single Deflection Grille - Horizontal / Vertical Blades)

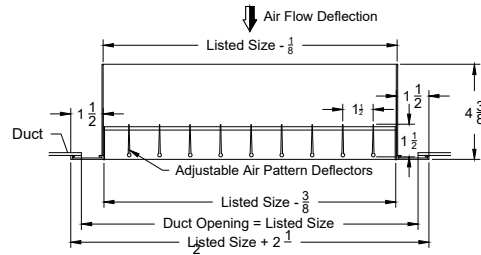

Face View (All models)

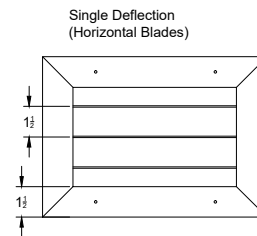

Model: XG-H4152-IF / XG-V4152-IF (Single Deflection Grille - Inverted Frame - Horizontal / Vertical)

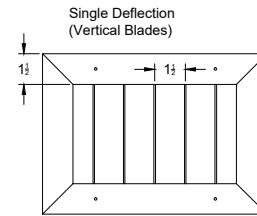
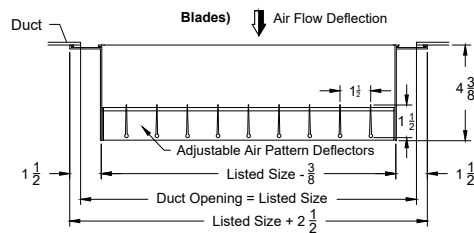

Option: XG-H4152 / XG-V4152 (Single Deflection Register With Opposed Blade Damper - Horizontal / Vertical Blades)

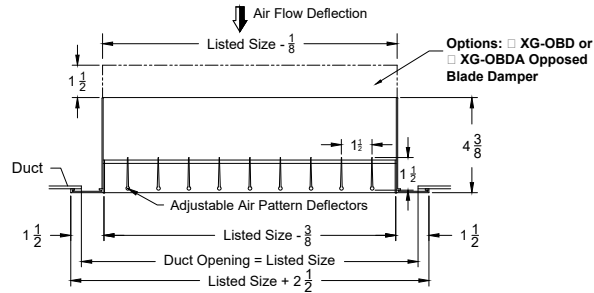

Single Deflection
(Horizontal & Vertical Blades)

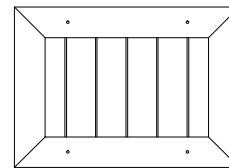

MODEL XG-4152 TLF

Sidewall Industrial Supply Grilles / Registers Aluminum - 1 1/2 Blade Spacing - With Trunk Latch Frame

Models: XG-V4152-TLF Single Deflection Grille - Vertical Blades
 XG-H4152-TLF Single Deflection Grille - Horizontal Blades

Models: XG-H4152-TLF / XG-V4152-TLF (Single Deflection Grille - With Trunk Latch Frame)
(Horizontal / Vertical Blades)

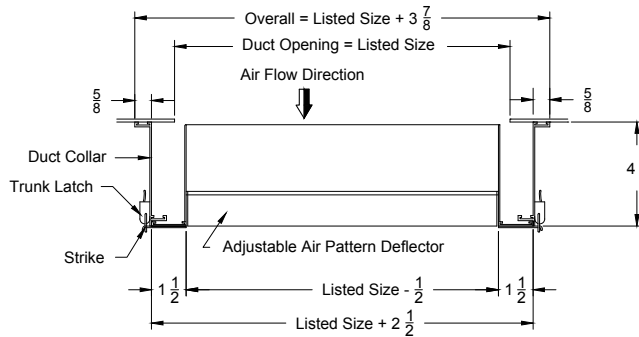

Face View (All models)

Single Deflection
(Horizontal Blades)

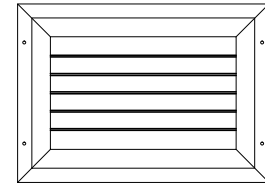

Single Deflection
(Vertical Blades)

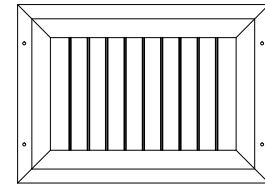

Options: XG-H4152-TLF / XG-V4152-TLF (Single Deflection Register - With Opposed Blade Damper)
(Trunk Latch Frame - Horizontal Front Blades)

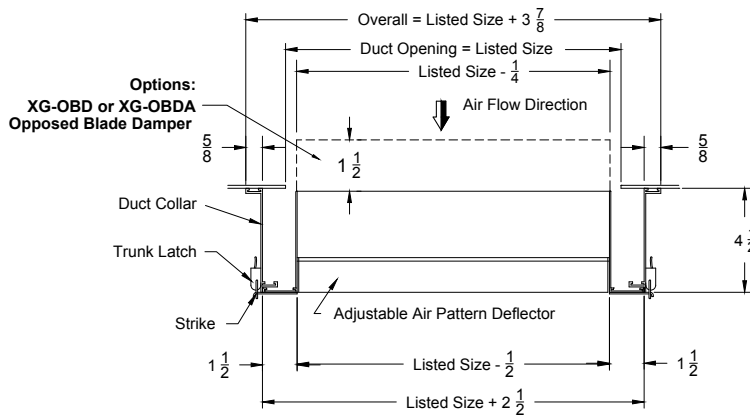

Options:
XG-OBDA or XG-OBDA
Opposed Blade Damper

MODEL XG-4154

Sidewall Industrial Supply Grilles / Registers - Double Deflection Aluminum - 4 3/8" Frame Depth - 1 1/2" Blade Spacing

- Models: **XG-V4154** Double Deflection Grille - Vertical Front Blades
 XG-H4154 Double Deflection Grille - Horizontal Front Blades
 XG-V4154 IF Double Deflection Grille - Vertical Front Blades - Inverted Frame
 XG-H4154 IF Double Deflection Grille - Horizontal Front Blades - Inverted Frame

Model: XG-H4154 (Double Deflection Grille - Horizontal / Vertical Blades)

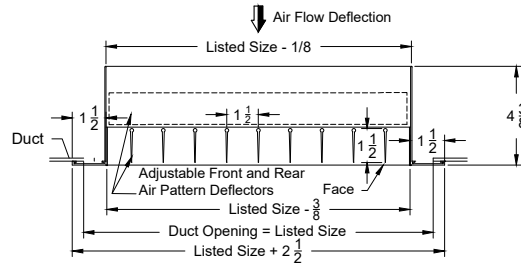

Face View (All models)

Double Deflection
(Horizontal Front Blades)

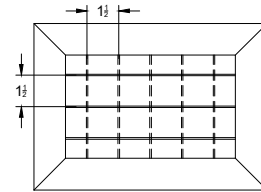

Model: XG-H4154 IF (Double Deflection Grille - Inverted Frame - Horizontal / Vertical Front Blades)

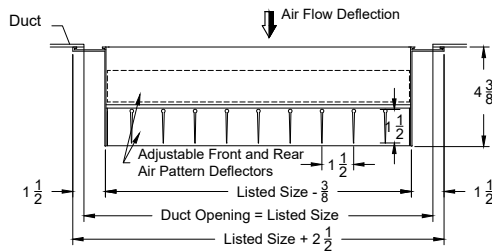

Option: XG-H4154 (Double Deflection Register with Opposed Blade Damper - Horizontal / Vertical Front Blades)

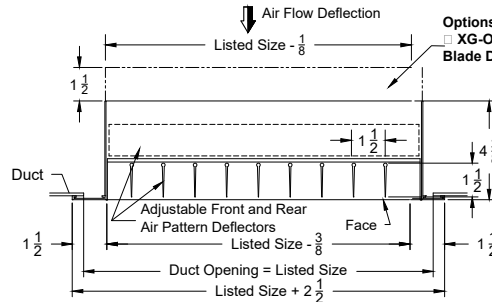

Options: XG-OBDD or
 XG-OBDA Opposed
 Blade Damper

Double Deflection
(Vertical Front Blades)

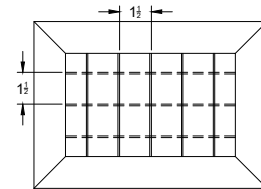

MODEL XG-4154 TLF

Side wall Industrial Supply Grilles / Registers Aluminum - 1 1/2" Blade Spacing - With Trunk Latch Frame

Models: XG-V4154-TLF Double Deflection Grille - Vertical Front Blades
 XG-H4154-TLF Double Deflection Grille - Horizontal Front Blades

Models: XG-H4154-TLF / XG-V4154-TLF (Double Deflection Grille - With Trunk Latch Frame)
(Horizontal / Vertical Blades)

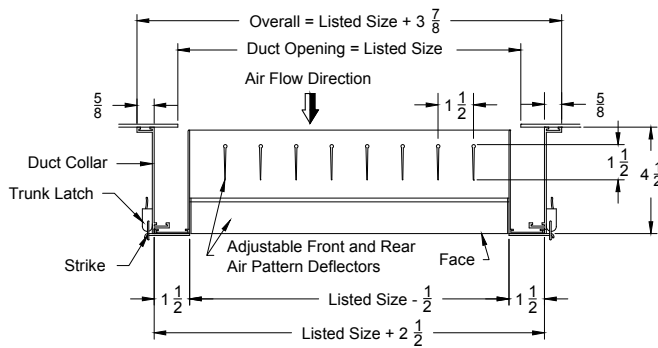

Face View (All models)

Double Deflection
(Horizontal Front Blades)

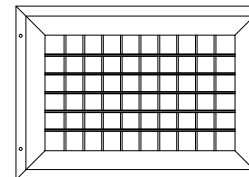

Double Deflection
(Vertical Front Blades)

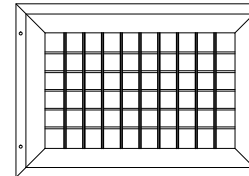

Options: XG-H4154D-TLF / XG-V4154D-TLF (Double Deflection Register - With Opposed Blade Damper)
(Trunk Latch Frame - Horizontal Front Blades)

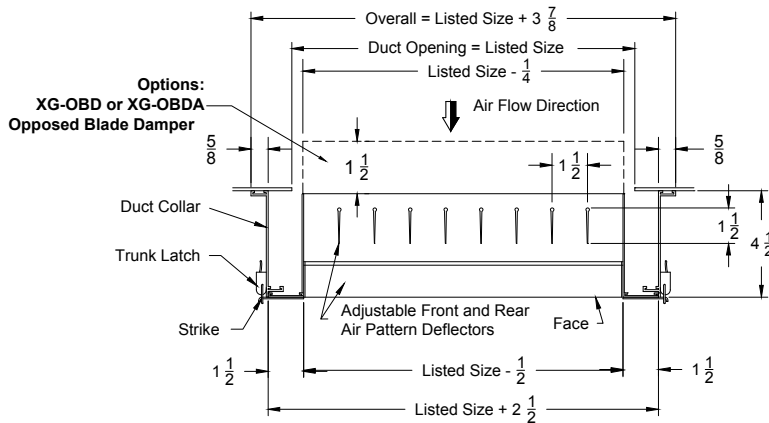

MODEL XG-4252

Sidewall Industrial Supply Grilles / Registers - Shallow Frame Extruded Aluminum - With Trunk Latch Frame - 1 1/2 Blade Spacing

Models: XG-V4252-TLF Single Deflection Grille - With Trunk Latch Frame - Vertical Blades
 XG-H4252-TLF Single Deflection Grille - With Latch Trunk Frame - Horizontal Blades

Models: XG-H4252-TLF / XG-V4252-TLF (Single Deflection Grille - With Trunk Latch Frame)
 (Horizontal or Vertical Front Blades)

Face View (All models)

Single Deflection
 (Horizontal Blades)

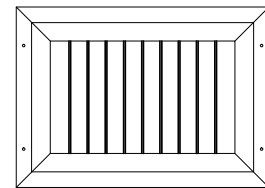

Single Deflection
 (Vertical Blades)

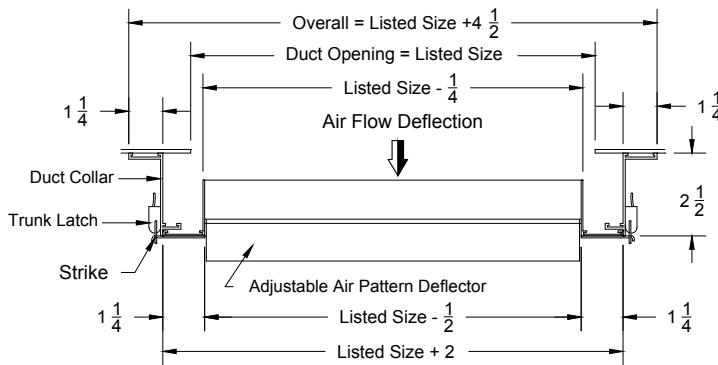
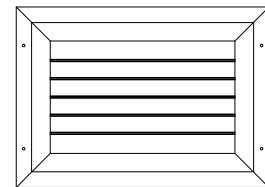

Options: XG-H4252-TLF / XG-V4252-TLF (Single Deflection Register - With Opposed Blade Damper - With Trunk Latch)
 (Horizontal or Vertical Front Blades)

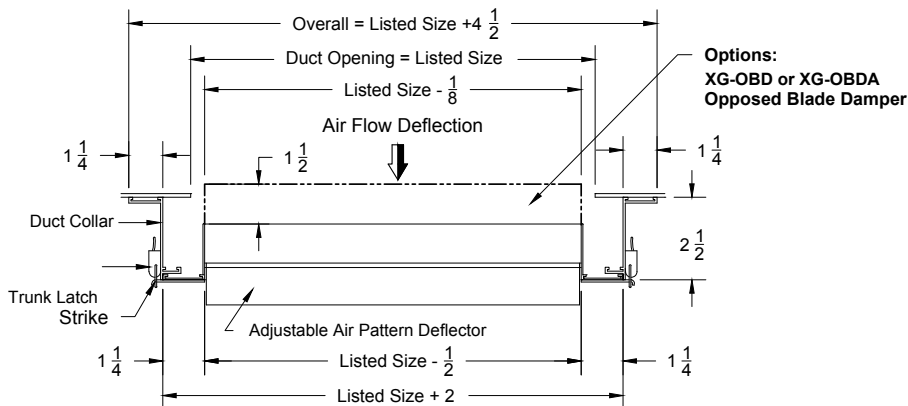

MODEL XG-4254

Sidewall Industrial Supply Grilles - Shallow Frame Extruded Aluminum - 1 1/2 Blade Spacing

- Models: **XG-V4254** Double Deflection Grille - Vertical Front Blades
 XG-H4254 Double Deflection Grille - Horizontal Front Blades
 XG-V4254-IF Double Deflection Grille - Vertical Front Blades - Inverted Frame
 XG-H4254-IF Double Deflection Grille - Horizontal Front Blades - Inverted Frame

Model: XG-H4254 / XG-V4254 (Double Deflection Grille) (Horizontal or Vertical Front Blades)

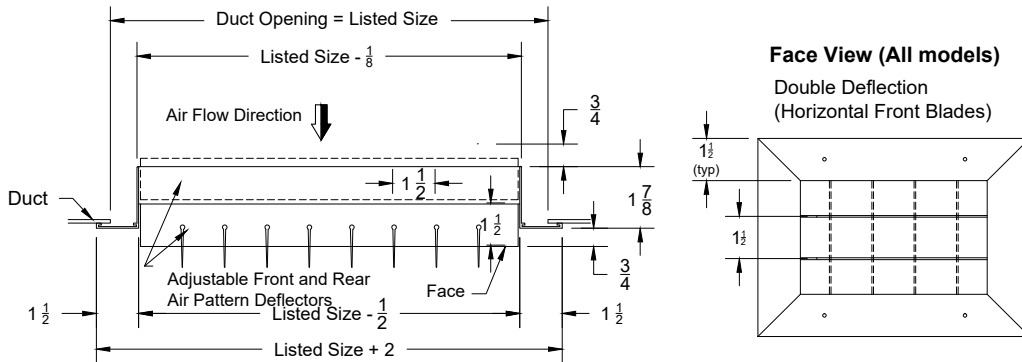

Model: XG-H4254-IF / XG-V4254-IF (Double Deflection Grille - Inverted Frame) (Horizontal or Vertical Front Blades)

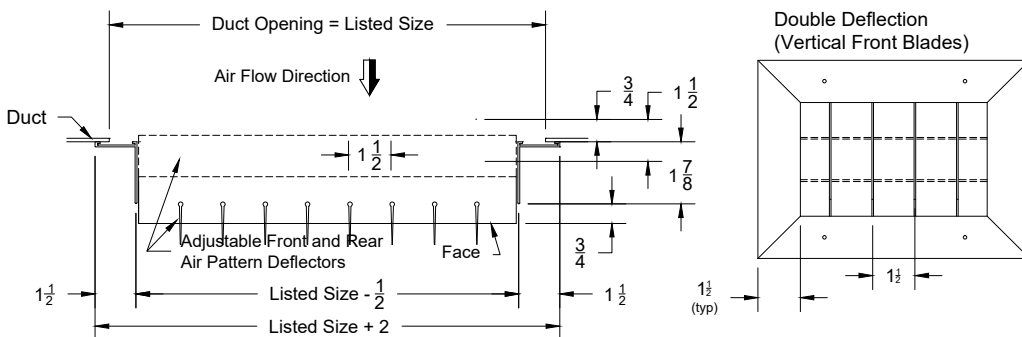

MODEL XG-4254 TLF

Sidewall Industrial Supply Grilles / Registers - Shallow Frame Extruded Aluminum - With Trunk Latch Frame - 1 1/2 Blade Spacing

Models **XG-V4254-TLF** Double Deflection Grille - With Trunk Latch Frame - Vertical Front Blades
 XG-H4254-TLF Double Deflection Grille - With Latch Trunk Frame - Horizontal Front Blades

Model: XG-H4254-TLF / XG-V4254-TLF (Double Deflection Grille - With Trunk Latch Frame) (Horizontal or Vertical Front Blades)

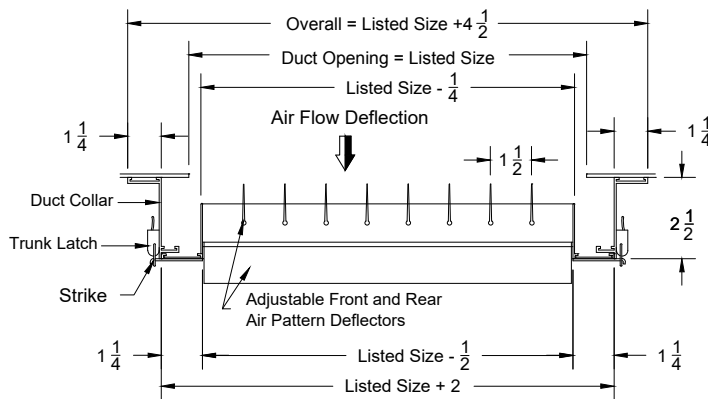

Face View (All models)

Double Deflection
(Horizontal Front Blades)

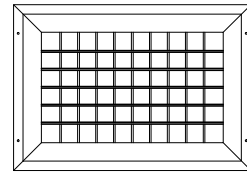

Double Deflection
(Vertical Front Blades)

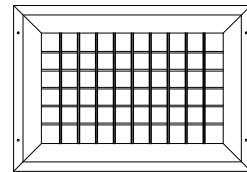

MODEL XG-4352

Side wall Industrial Supply Grilles / Registers - Single deflection Extruded Aluminum - 7" Frame Depth - 3" Blade Spacing

- Models XG-V4352 Single Deflection Grille - Vertical Blades
 XG-H4352 Single Deflection Grille - Horizontal Blades

Model: XG-H4352 / XG-V4352 (Single Deflection Grille - Horizontal / Vertical Blades)

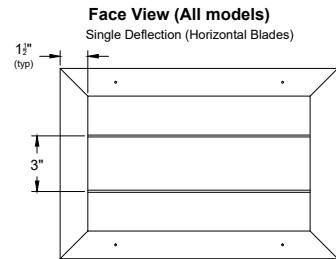
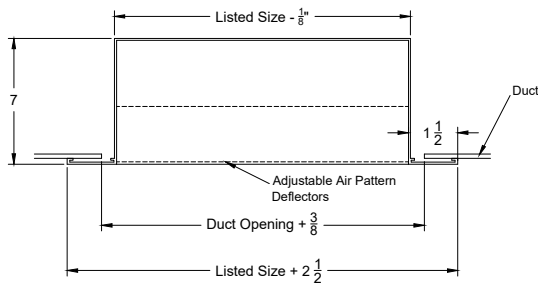

Option: XG-H4352 / XG-V4352 (Single Deflection Register - With Opposed Blade Damper) Single Deflection (Vertical Blades)
(Horizontal / Vertical Blades)

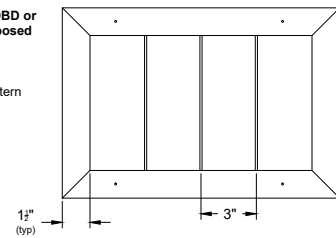
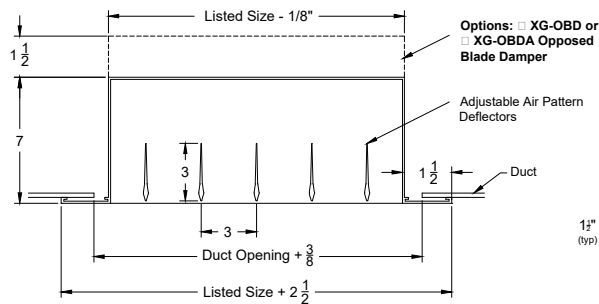

MODEL XG-4354

Sidewall Industrial Supply Grilles / Registers - Double deflection Extruded Aluminum - 7" Frame Depth - 3" Blade Spacing

Models XG-V4354 Double Deflection Grille - Vertical Front Blades
 XG-H4354 Double Deflection Grille - Horizontal Front Blades

Model: XG-H4354 / XG-V4354 (Double Deflection Grille - Horizontal / Vertical Front Blades)

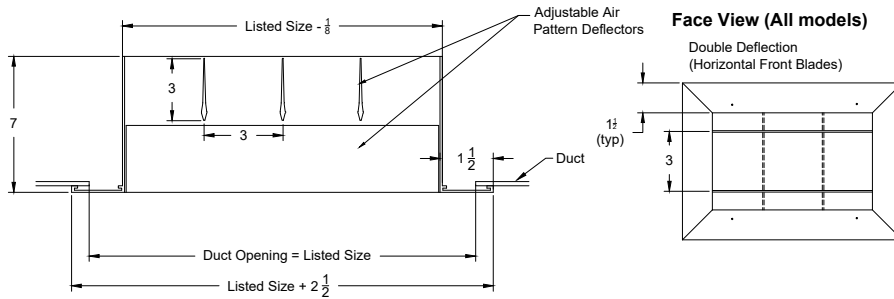

Option: XG-H4354 / XG-V4354 (Double Deflection Register - With Opposed Blade Damper) (Horizontal / Vertical Front Blades)

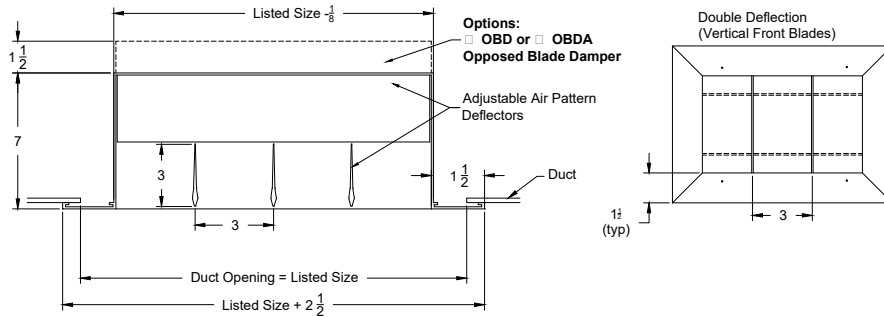

**XG-4100 MODEL NUMBER SPECIFICATION
XG-4100 INDUSTRIAL GRILLE**

Model		Neck											
		6	8	10	12	14	16	18	20	22	24	26	
V4152	Vertical Single Deflection		X	X	X	X	X	X	X	X	X	X	
H4152	Horizontal Single Deflection	4	X	X	X	X	X	X	X	X	X	X	
V4154	Vertical Double Deflection	5	X	X	X	X	X	X	X	X	X	X	
H4154	Horizontal Double Deflection	6	X	X	X	X	X	X	X	X	X	X	
V4152 IF	Vertical Single Deflection Inverted Frame	8	X	X	X	X	X	X	X	X	X	X	
H4152 IF	Horizontal Single Deflection Inverted Frame	10	X	X	X	X	X	X	X	X	X	X	
V4154 IF	Vertical Double Deflection Inverted Frame	12	X	X	X	X	X	X	X	X	X	X	
H4154 IF	Horizontal Double Deflection Inverted Frame	14	X	X	X	X	X	X	X	X	X	X	
		16	X	X	X	X	X	X	X	X	X	X	
		18	X	X	X	X	X	X	X	X	X	X	
		20	X	X	X	X	X	X	X	X	X	X	
		22	X	X	X	X	X	X	X	X	X	X	
		24	X	X	X	X	X	X	X	X	X	X	
		26	X	X	X	X	X	X	X	X	X	X	
		28	X	X	X	X	X	X	X	X	X	X	
		30	X	X	X	X	X	X	X	X	X	X	
		32	X	X	X	X	X	X	X	X	X	X	
		34	X	X	X	X	X	X	X	X	X	X	
		36	X	X	X	X	X	X	X	X	X	X	
		38	X	X	X	X	X	X	X	X	X	X	
		40	X	X	X	X	X	X	X	X	X	X	
		42	X	X	X	X	X	X	X	X	X	X	
		44	X	X	X	X	X	X	X	X	X	X	
		46	X	X	X	X	X	X	X	X	X	X	
		48	X	X	X	X	X	X	X	X	X	X	

Available Finishes		Available Accessories	
Standard		OBD	Steel Opposed Blade Damper
02	Satin Silver	OBDA	Aluminum Opposed Blade Damper
Optional		GOV	Gang Operator Vertical
01	White	GOH	Gang Operator Horizontal
03	Black	AF	Air Foil Blades
04	Clear Anodized		
24	Mill		
28	Custom Color		

XG-4100 MODEL NUMBER SPECIFICATION

XG-4100 INDUSTRIAL GRILLE

Model		Neck											
		28	30	32	34	36	38	40	42	44	46	48	
V4152	Vertical Single Deflection												
H4152	Horizontal Single Deflection	4	X	X	X	X	X	X	X	X	X	X	
V4154	Vertical Double Deflection	5	X	X	X	X	X	X	X	X	X	X	
H4154	Horizontal Double Deflection	6	X	X	X	X	X	X	X	X	X	X	
V4152 IF	Vertical Single Deflection Inverted Frame	8	X	X	X	X	X	X	X	X	X	X	
H4152 IF	Horizontal Single Deflection Inverted Frame	10	X	X	X	X	X	X	X	X	X	X	
V4154 IF	Vertical Double Deflection Inverted Frame	12	X	X	X	X	X	X	X	X	X	X	
H4154 IF	Horizontal Double Deflection Inverted Frame	14	X	X	X	X	X	X	X	X	X	X	
		16	X	X	X	X	X	X	X	X	X	X	
		18	X	X	X	X	X	X	X	X	X	X	
		20	X	X	X	X	X	X	X	X	X	X	
		22	X	X	X	X	X	X	X	X	X	X	
		24	X	X	X	X	X	X	X	X	X	X	
		26	X	X	X	X	X	X	X	X	X	X	
		28	X	X	X	X	X	X	X	X	X	X	
		30	X	X	X	X	X	X	X	X	X	X	
		32	X	X	X	X	X	X	X	X	X	X	
		34	X	X	X	X	X	X	X	X	X	X	
		36	X	X	X	X	X	X	X	X	X	X	
		38	X	X	X	X	X	X	X	X	X	X	
		40	X	X	X	X	X	X	X	X	X	X	
		42	X	X	X	X	X	X	X	X	X	X	
		44	X	X	X	X	X	X	X	X	X	X	
		46	X	X	X	X	X	X	X	X	X	X	
		48	X	X	X	X	X	X	X	X	X	X	

Available Finishes		Available Accessories	
Standard		OBD	Steel Opposed Blade Damper
02	Satin Silver	OBDA	Aluminum Opposed Blade Damper
Optional		GOV	Gang Operator Vertical
01	White	GOH	Gang Operator Horizontal
03	Black	AF	Air Foil Blades
04	Clear Anodized		
24	Mill		
28	Custom Color		

XG-4100 MODEL NUMBER SPECIFICATION

XG-4100 INDUSTRIAL GRILLE

Model		Neck											
		6	8	10	12	14	16	18	20	22	24	26	
XG-V4152-TLF	Single Def. Vert. Blades Trunk Latch Frame												
XG-H4152-TLF	Single Def. Hor. Blades Trunk Latch Frame	6	X	X	X	X	X	X	X	X	X	X	
XG-V4154-TLF	Dble Def. Vert. Blades Trunk Latch Frame	8		X	X	X	X	X	X	X	X	X	
XG-H4154-TLF	Dble Def. Hor. Blades Trunk Latch Frame	10			X	X	X	X	X	X	X	X	
		12				X	X	X	X	X	X	X	
		14					X	X	X	X	X	X	
		16						X	X	X	X	X	
		18							X	X	X	X	
		20								X	X	X	
		22									X	X	
		24										X	
		26											X

Model		Neck										
		28	30	32	34	36	38	40	42	44	46	48
XG-V4152-TLF	Single Def. Vert. Blades Trunk Latch Frame											
XG-H4152-TLF	Single Def. Hor. Blades Trunk Latch Frame	6	X	X	X	X	X	X	X	X	X	X
XG-V4154-TLF	Dble Def. Vert. Blades Trunk Latch Frame	8	X	X	X	X	X	X	X	X	X	X
XG-H4154-TLF	Dble Def. Hor. Blades Trunk Latch Frame	10	X	X	X	X	X	X	X	X	X	X
		12	X	X	X	X	X	X	X	X	X	X
		14	X	X	X	X	X	X	X	X	X	X
		16	X	X	X	X	X	X	X	X	X	X
		18	X	X	X	X	X	X	X	X	X	X
		20	X	X	X	X	X	X	X	X	X	X
		22	X	X	X	X	X	X	X	X	X	X
		24	X	X	X	X	X	X	X	X	X	X
		26	X	X	X	X	X	X	X	X	X	X

Available Finishes		Available Accessories	
Standard		XG-OBDA	Steel Opposed Blade Damper
02	Satin Silver	XG-OBDA	Aluminum Opposed Blade Damper
Optional		XG-GOV	Gang Operator Vertical
01	White	XG-GOH	Gang Operator Horizontal
03	Black	XG-AF	Air Foil Blades
04	Clear Anodize		
24	Mill		
28	Custom Color		

XG-4100 MODEL NUMBER SPECIFICATION
XG-4100 INDUSTRIAL GRILLE

Model		Neck											
		28	30	32	34	36	38	40	42	44	46	48	
XG-V4152-TLF	Single Def. Vert. Blades Trunk Latch Frame		X	X	X	X	X	X	X	X	X	X	
XG-H4152-TLF	Single Def. Hor. Blades Trunk Latch Frame	28	X	X	X	X	X	X	X	X	X	X	
XG-V4154-TLF	Dble Def. Vert. Blades Trunk Latch Frame	30		X	X	X	X	X	X	X	X	X	
XG-H4154-TLF	Dble Def. Hor. Blades Trunk Latch Frame	32			X	X	X	X	X	X	X	X	
		34				X	X	X	X	X	X	X	
		36					X	X	X	X	X	X	
		38						X	X	X	X	X	
		40							X	X	X	X	
		42								X	X	X	
		44									X	X	
		46										X	
		48											X

Available Finishes		Available Accessories	
Standard		XG-OB	Steel Opposed Blade Damper
02	Satin Silver	XG-OBDA	Aluminum Opposed Blade Damper
Optional		XG-GOV	Gang Operator Vertical
01	White	XG-GOH	Gang Operator Horizontal
03	Black	XG-AF	Air Foil Blades
04	Clear Anodize		
24	Mill		
28	Custom Color		

XG-4100 MODEL NUMBER SPECIFICATION
XG-4100 INDUSTRIAL GRILLE

Model		Cores				Available Finishes	
XG-V4152-MF	Single Deflection Vertical Blades Modular Frame		1	2	3	4	Standard
XG-H4152-MF	Single Deflection Horizontal Blades Modular Frame	8 x 8	X	X	X	X	02 Satin Silver
XG-V4154-MF	Double Deflection Vertical Blades Modular Frame	10 x 10	X	X	X	X	Optional
XG-H4154-MF	Double Deflection Horizontal Blades Modular Frame	12 x 12	X	X	X	X	01 White
		15 x 15	X	X	X	X	03 Black
							04 Clear Anodize
							24 Mill
						28 Custom Color	

Available Accessories	
XG-GOV	Gang Operator Vertical
XG-GOH	Gang Operator Horizontal
XG-AF	Air Foil Blades

XG-4200 MODEL NUMBER SPECIFICATION

XG-4200 INDUSTRIAL GRILLE

Model		Neck											
		6	8	10	12	14	16	18	20	22	24	26	
XG-V4252	Vertical Single Deflection												
XG-H4252	Horizontal Single Deflection	6	X	X	X	X	X	X	X	X	X	X	
XG-V4254	Vertical Double Deflection	8	X	X	X	X	X	X	X	X	X	XXG-	
XG-H4254	Horizontal Double Deflection	10	X	X	X	X	X	X	X	X	X	X	
XG-V4252 IF	Vertical Single Deflection Inverted Frame	12	X	X	X	X	X	X	X	X	X	X	
XG-H4252 IF	Horizontal Single Deflection Inverted Frame	14	X	X	X	X	X	X	X	X	X	X	
XG-V4254 IF	Vertical Double Deflection Inverted Frame	16	X	X	X	X	X	X	X	X	X	X	
XG-H4254 IF	Horizontal Double Deflection Inverted Frame	18	X	X	X	X	X	X	X	X	X	X	
		20	X	X	X	X	X	X	X	X	X	X	
		22	X	X	X	X	X	X	X	X	X	X	
		24	X	X	X	X	X	X	X	X	X	X	
		26	X	X	X	X	X	X	X	X	X	X	
		28	X	X	X	X	X	X	X	X	X	X	
		30	X	X	X	X	X	X	X	X	X	X	
		32	X	X	X	X	X	X	X	X	X	X	
		34	X	X	X	X	X	X	X	X	X	X	
		36	X	X	X	X	X	X	X	X	X	X	
		38	X	X	X	X	X	X	X	X	X	X	
		40	X	X	X	X	X	X	X	X	X	X	
		42	X	X	X	X	X	X	X	X	X	X	
		44	X	X	X	X	X	X	X	X	X	X	
		46	X	X	X	X	X	X	X	X	X	X	
		48	X	X	X	X	X	X	X	X	X	X	
		46	X	X	X	X	X	X	X	X	X	X	
		48	X	X	X	X	X	X	X	X	X	X	

Available Finishes		Available Accessories	
Standard		XG-GOV	Gang Operator Vertical
02	Satin Silver	XG-GOH	Gang Operator Horizontal
Optional		XG-AF	Air Foil Blades
01	White		
03	Black		
04	Clear Anodize		
24	Mill		
28	Custom Color		

Available Finishes		Available Accessories	
Standard		XG-OB	Steel Opposed Blade Damper
02	Satin Silver	XG-OBDA	Aluminum Opposed Blade Damper
Optional		XG-GOV	Gang Operator Vertical
01	White	XG-GOH	Gang Operator Horizontal
03	Black	XG-AF	Air Foil Blades
04	Clear Anodize		
24	Mill		
28	Custom Color		

XG-4200 MODEL NUMBER SPECIFICATION
XG-4200 INDUSTRIAL GRILLE

Model		Neck											
		28	30	32	34	36	38	40	42	44	46	48	
XG-V4252	Vertical Single Deflection												
XG-H4252	Horizontal Single Deflection	6	X	X	X	X	X	X	X	X	X	X	
XG-V4254	Vertical Double Deflection	8	X	X	X	X	X	X	X	X	X	X	
XG-H4254	Horizontal Double Deflection	10	X	X	X	X	X	X	X	X	X	X	
XG-V4252 IF	Vertical Single Deflection Inverted Frame	12	X	X	X	X	X	X	X	X	X	X	
XG-H4252 IF	Horizontal Single Deflection Inverted Frame	14	X	X	X	X	X	X	X	X	X	X	
XG-V4254 IF	Vertical Double Deflection Inverted Frame	16	X	X	X	X	X	X	X	X	X	X	
XG-H4254 IF	Horizontal Double Deflection Inverted Frame	18	X	X	X	X	X	X	X	X	X	X	
		20	X	X	X	X	X	X	X	X	X	X	
		22	X	X	X	X	X	X	X	X	X	X	
		24	X	X	X	X	X	X	X	X	X	X	
		26	X	X	X	X	X	X	X	X	X	X	
		28	X	X	X	X	X	X	X	X	X	X	
		30	X	X	X	X	X	X	X	X	X	X	
		32	X	X	X	X	X	X	X	X	X	X	
		34	X	X	X	X	X	X	X	X	X	X	
		36	X	X	X	X	X	X	X	X	X	X	
		38	X	X	X	X	X	X	X	X	X	X	
		40	X	X	X	X	X	X	X	X	X	X	
		42	X	X	X	X	X	X	X	X	X	X	
		44	X	X	X	X	X	X	X	X	X	X	
		46	X	X	X	X	X	X	X	X	X	X	
		48	X	X	X	X	X	X	X	X	X	X	
		46	X	X	X	X	X	X	X	X	X	X	
		48	X	X	X	X	X	X	X	X	X	X	

Available Finishes		Available Accessories	
Standard		XG-GOV	Gang Operator Vertical
02	Satin Silver	XG-GOH	Gang Operator Horizontal
Optional		XG-AF	Air Foil Blades
01	White		
03	Black		
04	Clear Anodize		
24	Mill		
28	Custom Color		

XG-4200 MODEL NUMBER SPECIFICATION

XG-4200 INDUSTRIAL GRILLE

Model		Neck											
		6	8	10	12	14	16	18	20	22	24	26	
XG-V4252-TLF	Single Def. Vert. Blades Trunk Latch Frame												
XG-H4252-TLF	Single Def. Hor. Blades Trunk Latch Frame	6	X	X	X	X	X	X	X	X	X	X	
XG-V4254-TLF	Dble Def. Vert. Blades Trunk Latch Frame	8		X	X	X	X	X	X	X	X	X	
XG-H4254-TLF	Dble Def. Hor. Blades Trunk Latch Frame	10			X	X	X	X	X	X	X	X	
		12				X	X	X	X	X	X	X	
		14					X	X	X	X	X	X	
		16						X	X	X	X	X	
		18							X	X	X	X	
		20								X	X	X	
		22									X	X	
		24										X	
		26											X

Model		Neck										
		28	30	32	34	36	38	40	42	44	46	48
XG-V4252-TLF	Single Def. Vert. Blades Trunk Latch Frame											
XG-H4252-TLF	Single Def. Hor. Blades Trunk Latch Frame	6	X	X	X	X	X	X	X	X	X	X
XG-V4254-TLF	Dble Def. Vert. Blades Trunk Latch Frame	8	X	X	X	X	X	X	X	X	X	X
XG-H4254-TLF	Dble Def. Hor. Blades Trunk Latch Frame	10	X	X	X	X	X	X	X	X	X	X
		12	X	X	X	X	X	X	X	X	X	X
		14	X	X	X	X	X	X	X	X	X	X
		16	X	X	X	X	X	X	X	X	X	X
		18	X	X	X	X	X	X	X	X	X	X
		20	X	X	X	X	X	X	X	X	X	X
		22	X	X	X	X	X	X	X	X	X	X
		24	X	X	X	X	X	X	X	X	X	X
		26	X	X	X	X	X	X	X	X	X	X

Available Finishes		Available Accessories	
Standard		XG-GOV	Gang Operator Vertical
02	Satin Silver	XG-GOH	Gang Operator Horizontal
Optional		XG-AF	Air Foil Blades
01	White		
03	Black		
04	Clear Anodize		
24	Mill		
28	Custom Color		

XG-4200 MODEL NUMBER SPECIFICATION
XG-4200 INDUSTRIAL GRILLE

Model		Neck											
		28	30	32	34	36	38	40	42	44	46	48	
XG-V4252-TLF	Single Def. Vert. Blades Trunk Latch Frame		X	X	X	X	X	X	X	X	X	X	
XG-H4252-TLF	Single Def. Hor. Blades Trunk Latch Frame	28	X	X	X	X	X	X	X	X	X	X	
XG-V4254-TLF	Dble Def. Vert. Blades Trunk Latch Frame	30		X	X	X	X	X	X	X	X	X	
XG-H4254-TLF	Dble Def. Hor. Blades Trunk Latch Frame	32			X	X	X	X	X	X	X	X	
		34				X	X	X	X	X	X	X	
		36					X	X	X	X	X	X	
		38						X	X	X	X	X	
		40							X	X	X	X	
		42								X	X	X	
		44									X	X	
		46										X	
		48											X

Available Finishes		Available Accessories	
Standard		XG-GOV	Gang Operator Vertical
02	Satin Silver	XG-GOH	Gang Operator Horizontal
Optional		XG-AF	Air Foil Blades
01	White		
03	Black		
04	Clear Anodize		
24	Mill		
28	Custom Color		

XG-4200 MODEL NUMBER SPECIFICATION
XG-4200 INDUSTRIAL GRILLE

Model		Cores				Available Finishes		
			1	2	3	4		
XG-V4252-MF	Single Deflection Vertical Blades Modular Frame						Standard	
XG-H4252-MF	Single Deflection Horizontal Blades Modular Frame	8 x 8	X	X	X	X	02	Satin Silver
XG-V4254-MF	Double Deflection Vertical Blades Modular Frame	10 x 10	X	X	X	X	Optional	
XG-H4254-MF	Double Deflection Horizontal Blades Modular Frame	12 x 12	X	X	X	X	01	White
		15 x 15	X	X	X	X	03	Black
							04	Clear Anodize
							24	Mill
							28	Custom Color

Available Accessories	
XG-GOV	Gang Operator Vertical
XG-GOH	Gang Operator Horizontal
XG-AF	Air Foil Blades

XG-4300 MODEL NUMBER SPECIFICATION
XG-4300 INDUSTRIAL GRILLE

Model		Neck										
		6	8	10	12	14	16	18	20	22	24	26
XG-V4352	Vertical Single Deflection											
XG-H4352	Horizontal Single Deflection	6	X	X	X	X	X	X	X	X	X	X
XG-V4354	Vertical Double Deflection	8	X	X	X	X	X	X	X	X	X	X
XG-H4354	Horizontal Double Deflection	10	X	X	X	X	X	X	X	X	X	X
XG-V4352-IF	Vertical Single Deflection Inverted Frame	12	X	X	X	X	X	X	X	X	X	X
XG-H4352-IF	Horizontal Single Deflection Inverted Frame	14	X	X	X	X	X	X	X	X	X	X
XG-V4354-IF	Vertical Double Deflection Inverted Frame	16	X	X	X	X	X	X	X	X	X	X
XG-H4354-IF	Horizontal Double Deflection Inverted Frame	18	X	X	X	X	X	X	X	X	X	X
		20	X	X	X	X	X	X	X	X	X	X
		22	X	X	X	X	X	X	X	X	X	X
		24	X	X	X	X	X	X	X	X	X	X
		26	X	X	X	X	X	X	X	X	X	X
		28	X	X	X	X	X	X	X	X	X	X
		30	X	X	X	X	X	X	X	X	X	X
		32	X	X	X	X	X	X	X	X	X	X
		34	X	X	X	X	X	X	X	X	X	X
		36	X	X	X	X	X	X	X	X	X	X
		38	X	X	X	X	X	X	X	X	X	X
		40	X	X	X	X	X	X	X	X	X	X
		42	X	X	X	X	X	X	X	X	X	X
		44	X	X	X	X	X	X	X	X	X	X
		46	X	X	X	X	X	X	X	X	X	X
		48	X	X	X	X	X	X	X	X	X	X
		46	X	X	X	X	X	X	X	X	X	X
		48	X	X	X	X	X	X	X	X	X	X

Available Finishes		Available Accessories	
Standard		XG-OBDA	Steel Opposed Blade Damper
02	Satin Silver	XG-OBDA	Aluminum Opposed Blade Damper
Optional		XG-GOV	Gang Operator Vertical
01	White	XG-GOH	Gang Operator Horizontal
03	Black	XG-AF	Air Foil Blades
04	Clear Anodize		
24	Mill		
28	Custom Color		

**XG-4300 MODEL NUMBER SPECIFICATION
XG-4300 INDUSTRIAL GRILLE**

Model		Neck											
		28	30	32	34	36	38	40	42	44	46	48	
XG-V4352	Vertical Single Deflection												
XG-H4352	Horizontal Single Deflection	6	X	X	X	X	X	X	X	X	X	X	
XG-V4354	Vertical Double Deflection	8	X	X	X	X	X	X	X	X	X	X	
XG-H4354	Horizontal Double Deflection	10	X	X	X	X	X	X	X	X	X	X	
XG-V4352-IF	Vertical Single Deflection Inverted Frame	12	X	X	X	X	X	X	X	X	X	X	
XG-H4352-IF	Horizontal Single Deflection Inverted Frame	14	X	X	X	X	X	X	X	X	X	X	
XG-V4354-IF	Vertical Double Deflection Inverted Frame	16	X	X	X	X	X	X	X	X	X	X	
XG-H4354-IF	Horizontal Double Deflection Inverted Frame	18	X	X	X	X	X	X	X	X	X	X	
		20	X	X	X	X	X	X	X	X	X	X	
		22	X	X	X	X	X	X	X	X	X	X	
		24	X	X	X	X	X	X	X	X	X	X	
		26	X	X	X	X	X	X	X	X	X	X	
		28	X	X	X	X	X	X	X	X	X	X	
		30	X	X	X	X	X	X	X	X	X	X	
		32	X	X	X	X	X	X	X	X	X	X	
		34	X	X	X	X	X	X	X	X	X	X	
		36	X	X	X	X	X	X	X	X	X	X	
		38	X	X	X	X	X	X	X	X	X	X	
		40	X	X	X	X	X	X	X	X	X	X	
		42	X	X	X	X	X	X	X	X	X	X	
		44	X	X	X	X	X	X	X	X	X	X	
		46	X	X	X	X	X	X	X	X	X	X	
		48	X	X	X	X	X	X	X	X	X	X	
		46	X	X	X	X	X	X	X	X	X	X	
		48	X	X	X	X	X	X	X	X	X	X	

Available Finishes		Available Accessories	
Standard		XG-OBDA	Steel Opposed Blade Damper
02	Satin Silver	XG-OBDA	Aluminum Opposed Blade Damper
Optional		XG-GOV	Gang Operator Vertical
01	White	XG-GOH	Gang Operator Horizontal
03	Black	XG-AF	Air Foil Blades
04	Clear Anodize		
24	Mill		
28	Custom Color		

XG-4300 MODEL NUMBER SPECIFICATION

XG-4300 INDUSTRIAL GRILLE

Model		Neck											
		6	8	10	12	14	16	18	20	22	24	26	
XG-V4352-TLF	Single Def. Vert. Blades Trunk Latch Frame		X	X	X	X	X	X	X	X	X	X	
XG-H4352-TLF	Single Def. Hor. Blades Trunk Latch Frame	6	X	X	X	X	X	X	X	X	X	X	
XG-V4354-TLF	Dble Def. Vert. Blades Trunk Latch Frame	8		X	X	X	X	X	X	X	X	X	
XG-H4354-TLF	Dble Def. Hor. Blades Trunk Latch Frame	10			X	X	X	X	X	X	X	X	
		12				X	X	X	X	X	X	X	
		14					X	X	X	X	X	X	
		16						X	X	X	X	X	
		18							X	X	X	X	
		20								X	X	X	
		22									X	X	
		24										X	
		26											X

Model		Neck										
		28	30	32	34	36	38	40	42	44	46	48
XG-V4352-TLF	Single Def. Vert. Blades Trunk Latch Frame		X	X	X	X	X	X	X	X	X	X
XG-H4352-TLF	Single Def. Hor. Blades Trunk Latch Frame	6	X	X	X	X	X	X	X	X	X	X
XG-V4354-TLF	Dble Def. Vert. Blades Trunk Latch Frame	8	X	X	X	X	X	X	X	X	X	X
XG-H4354-TLF	Dble Def. Hor. Blades Trunk Latch Frame	10	X	X	X	X	X	X	X	X	X	X
		12	X	X	X	X	X	X	X	X	X	X
		14	X	X	X	X	X	X	X	X	X	X
		16	X	X	X	X	X	X	X	X	X	X
		18	X	X	X	X	X	X	X	X	X	X
		20	X	X	X	X	X	X	X	X	X	X
		22	X	X	X	X	X	X	X	X	X	X
		24	X	X	X	X	X	X	X	X	X	X
		26	X	X	X	X	X	X	X	X	X	X

Available Finishes		Available Accessories	
Standard		XG-OBD	Steel Opposed Blade Damper
02	Satin Silver	XG-OBDA	Aluminum Opposed Blade Damper
Optional		XG-GOV	Gang Operator Vertical
01	White	XG-GOH	Gang Operator Horizontal
03	Black	XG-AF	Air Foil Blades
04	Clear Anodized		
24	Mill		
28	Custom Color		

XG-4300 MODEL NUMBER SPECIFICATION
XG-4300 INDUSTRIAL GRILLE

Model		Neck											
		28	30	32	34	36	38	40	42	44	46	48	
XG-V4252-TLF	Single Def. Vert. Blades Trunk Latch Frame		X	X	X	X	X	X	X	X	X	X	
XG-H4252-TLF	Single Def. Hor. Blades Trunk Latch Frame	28	X	X	X	X	X	X	X	X	X	X	
XG-V4254-TLF	Dble Def. Vert. Blades Trunk Latch Frame	30		X	X	X	X	X	X	X	X	X	
XG-H4254-TLF	Dble Def. Hor. Blades Trunk Latch Frame	32			X	X	X	X	X	X	X	X	
		34				X	X	X	X	X	X	X	
		36					X	X	X	X	X	X	
		38						X	X	X	X	X	
		40							X	X	X	X	
		42								X	X	X	
		44									X	X	
		46										X	
		48											X

Available Finishes		Available Accessories	
Standard		XG-OBDA	Steel Opposed Blade Damper
02	Satin Silver	XG-OBDA	Aluminum Opposed Blade Damper
Optional		XG-GOV	Gang Operator Vertical
01	White	XG-GOH	Gang Operator Horizontal
03	Black	XG-AF	Air Foil Blades
04	Clear Anodized		
24	Mill		
28	Custom Color		

XG-4300 MODEL NUMBER SPECIFICATION
XG-4300 INDUSTRIAL GRILLE

Model		Cores				Available Finishes	
		1	2	3	4	Standard	
XG-V4352-MF	Single Deflection Vertical Blades Modular Frame		X	X	X	02	Satin Silver
XG-H4352-MF	Single Deflection Horizontal Blades Modular Frame	8 x 8	X	X	X	Optional	
XG-V4354-MF	Double Deflection Vertical Blades Modular Frame	10 x 10	X	X	X	01	White
XG-H4354-MF	Double Deflection Horizontal Blades Modular Frame	12 x 12	X	X	X	03	Black
		15 x 15	X	X	X	04	Clear Anodized
						24	Mill
						28	Custom Color

Available Accessories	
XG-GOV	Gang Operator Vertical
XG-GOH	Gang Operator Horizontal
XG-AF	Air Foil Blades

SERIES XG-4100/XG-4200/XG-4300 PERFORMANCE DATA
MODELS XG-4100, XG-4200, XG-4300

Size	Pt	Nk Vel	300	400	500	600	700	800	900	1000
		0°	.012	.022	.034	.049	.067	.087	.110	.136
		22.5°	.015	.027	.043	.061	.084	.109	.138	.170
		45°	.021	.038	.059	.084	.115	.150	.190	.235
06x06	Ac ft ²	CFM	57	76	95	114	133	152	171	190
		0.19 NC	-	-	-	-	-	12	15	18
	Throw	0°	4 - 8 - 17	7 - 12 - 21	10 - 15 - 24	12 - 17 - 26	14 - 20 - 28	15 - 21 - 30	17 - 23 - 32	19 - 24 - 34
		22.5°	3 - 7 - 15	5 - 10 - 19	8 - 13 - 22	10 - 15 - 24	12 - 18 - 26	13 - 19 - 27	15 - 20 - 29	17 - 22 - 31
		45°	2 - 5 - 13	4 - 9 - 17	7 - 11 - 20	9 - 13 - 21	10 - 15 - 23	12 - 17 - 25	13 - 19 - 26	14 - 20 - 28
08x08 10x06 12x05	Ac ft ²	CFM	110	146	183	219	256	292	329	365
		0.37 NC	-	-	-	-	11	15	18	21
	Throw	0°	5 - 12 - 24	9 - 16 - 30	14 - 20 - 33	16 - 24 - 36	19 - 28 - 39	22 - 30 - 42	24 - 31 - 44	27 - 33 - 47
		22.5°	4 - 10 - 21	8 - 14 - 27	12 - 17 - 30	14 - 21 - 33	16 - 24 - 35	19 - 27 - 38	21 - 28 - 40	23 - 30 - 42
		45°	3 - 8 - 18	6 - 12 - 24	9 - 15 - 27	12 - 18 - 30	14 - 21 - 32	16 - 24 - 34	18 - 26 - 36	20 - 27 - 38
12x06	Ac ft ²	CFM	123	164	205	246	287	328	369	410
		0.41 NC	-	-	-	-	11	15	18	22
	Throw	0°	6 - 13 - 26	10 - 17 - 31	14 - 21 - 35	17 - 26 - 38	20 - 29 - 41	23 - 31 - 44	26 - 33 - 47	29 - 35 - 50
		22.5°	5 - 10 - 22	8 - 15 - 28	12 - 18 - 32	15 - 22 - 35	17 - 26 - 38	20 - 28 - 40	22 - 30 - 43	25 - 32 - 45
		45°	4 - 8 - 19	6 - 13 - 25	10 - 16 - 29	13 - 19 - 31	15 - 22 - 34	17 - 25 - 36	19 - 27 - 38	21 - 29 - 41
10x08 14x6	Ac ft ²	CFM	140	186	233	279	326	372	419	465
		0.47 NC	-	-	-	-	12	16	19	22
	Throw	0°	6 - 14 - 27	11 - 18 - 33	15 - 23 - 37	18 - 27 - 41	21 - 31 - 44	24 - 33 - 47	27 - 35 - 50	30 - 37 - 53
		22.5°	5 - 11 - 24	9 - 16 - 30	13 - 20 - 34	16 - 24 - 37	18 - 28 - 40	21 - 30 - 43	24 - 32 - 45	26 - 34 - 48
		45°	4 - 9 - 20	7 - 14 - 27	11 - 17 - 31	14 - 20 - 34	16 - 24 - 36	18 - 27 - 39	20 - 29 - 41	23 - 31 - 43
10x10 12x08 16x06	Ac ft ²	CFM	178	238	297	356	416	475	535	594
		0.59 NC	-	-	-	-	13	17	20	23
	Throw	0°	7 - 15 - 31	12 - 21 - 38	17 - 26 - 42	21 - 31 - 46	24 - 35 - 50	27 - 38 - 53	31 - 40 - 57	34 - 42 - 60
		22.5°	5 - 12 - 27	10 - 18 - 34	15 - 22 - 38	18 - 27 - 42	21 - 31 - 45	24 - 34 - 48	27 - 36 - 51	30 - 38 - 54
		45°	4 - 10 - 23	8 - 15 - 31	12 - 19 - 35	15 - 23 - 38	18 - 27 - 41	20 - 31 - 44	23 - 33 - 46	26 - 35 - 49
14x08 18x06	Ac ft ²	CFM	200	266	333	399	466	532	599	665
		0.67 NC	-	-	-	-	13	17	21	24
	Throw	0°	7 - 16 - 33	13 - 22 - 40	18 - 27 - 45	22 - 33 - 49	25 - 37 - 53	29 - 40 - 57	33 - 42 - 60	36 - 45 - 63
		22.5°	6 - 13 - 28	10 - 19 - 36	16 - 24 - 40	19 - 28 - 44	22 - 33 - 48	25 - 36 - 51	28 - 38 - 54	31 - 40 - 57
		45°	5 - 10 - 24	8 - 16 - 32	13 - 20 - 37	16 - 24 - 40	19 - 28 - 43	22 - 32 - 46	24 - 35 - 49	27 - 37 - 52
12x10 20x06	Ac ft ²	CFM	218	290	363	435	508	580	653	725
		0.73 NC	-	-	-	-	13	17	21	24
	Throw	0°	7 - 17 - 34	13 - 23 - 42	19 - 28 - 47	23 - 34 - 51	27 - 39 - 55	30 - 42 - 59	34 - 44 - 62	38 - 47 - 66
		22.5°	6 - 14 - 29	11 - 20 - 38	16 - 25 - 42	20 - 29 - 46	23 - 34 - 50	26 - 38 - 53	29 - 40 - 56	33 - 42 - 60
		45°	5 - 11 - 25	8 - 17 - 34	13 - 21 - 38	17 - 25 - 42	20 - 30 - 45	23 - 34 - 48	25 - 36 - 51	28 - 38 - 54

CONTINUED

SERIES XG-4100/XG-4200/XG-4300 PERFORMANCE DATA
MODELS XG-4100, XG-4200, XG-4300

Size	Pt	Nk Vel	300	400	500	600	700	800	900	1000
		0°	.012	.022	.034	.049	.067	.087	.110	.136
		22.5°	.015	.027	.043	.061	.084	.109	.138	.170
		45°	.021	.038	.059	.084	.115	.150	.190	.235
16x08	Ac ft ²	CFM	230	306	383	459	536	612	689	765
	0.77	NC	-	-	-	-	14	18	21	24
22x06	Throw	0°	8 - 17 - 35	14 - 23 - 43	20 - 29 - 48	23 - 35 - 53	27 - 40 - 57	31 - 43 - 61	35 - 45 - 64	39 - 48 - 68
		22.5°	6 - 14 - 30	11 - 20 - 39	17 - 25 - 43	20 - 30 - 48	24 - 35 - 51	27 - 39 - 55	30 - 41 - 58	34 - 43 - 61
		45°	5 - 11 - 26	9 - 17 - 35	14 - 22 - 39	17 - 26 - 43	20 - 30 - 46	23 - 35 - 50	26 - 37 - 53	29 - 39 - 56
14x10 28x05	Ac ft ²	CFM	255	340	425	510	595	680	765	850
	0.85	NC	-	-	-	-	14	18	22	25
14x10 28x05	Throw	0°	8 - 18 - 37	14 - 25 - 45	21 - 31 - 50	25 - 37 - 55	29 - 42 - 60	33 - 45 - 64	37 - 48 - 68	41 - 50 - 71
		22.5°	7 - 15 - 32	12 - 21 - 41	18 - 27 - 46	21 - 32 - 50	25 - 37 - 54	28 - 41 - 58	32 - 43 - 61	35 - 46 - 65
		45°	5 - 12 - 27	9 - 18 - 37	14 - 23 - 41	18 - 27 - 45	21 - 32 - 49	24 - 37 - 52	27 - 39 - 55	31 - 41 - 58
12x12 24x06 18x08 36x04	Ac ft ²	CFM	260	346	433	519	606	692	779	865
	0.87	NC	-	-	-	-	14	18	21	24
12x12 24x06 18x08 36x04	Throw	0°	8 - 19 - 38	14 - 25 - 46	21 - 31 - 51	25 - 37 - 56	29 - 43 - 60	33 - 46 - 64	37 - 48 - 68	41 - 51 - 72
		22.5°	7 - 15 - 32	12 - 22 - 41	18 - 27 - 46	21 - 32 - 51	25 - 37 - 55	28 - 41 - 58	32 - 44 - 62	36 - 46 - 65
		45°	5 - 12 - 28	9 - 19 - 37	14 - 23 - 42	18 - 28 - 46	21 - 32 - 49	25 - 37 - 53	28 - 40 - 56	31 - 42 - 59

PERFORMANCE NOTES FOR SERIES XG-4100, XG-4200, XG-4300

All data is tested in accordance with ANSI/ASHRAE 70-2006.

DEFINITION OF UNITS

CFM Cubic Feet per Minute (air)

Pt Total pressure (inches of water column)

Throw Throw distance in feet are for terminal velocities of 150 fpm, 100 fpm and 50 fpm respectively

NC Noise Criteria based on a room absorption of 10 dB, re: 10⁻¹² watts [NC les than 10 (-)]

Ac Actual Core Free Area in square feet

SERIES XG-4100/XG-4200/XG-4300 PERFORMANCE DATA
MODELS XG-4100, XG-4200, XG-4300

Size	Pt	Nk Vel	300	400	500	600	700	800	900	1000
		0°	.012	.022	.034	.049	.067	.087	.110	.136
		22.5°	.015	.027	.043	.061	.084	.109	.138	.170
		45°	.021	.038	.059	.084	.115	.150	.190	.235
16x10 20x08	Ac ft ²	CFM	294	392	490	587	685	783	881	979
		NC	-	-	-	-	15	19	22	25
	Throw	0°	9-20-40	15-26-48	22-33-54	26-40-59	31-45-64	35-48-68	40-51-73	44-54-77
		22.5°	7-16-34	12-23-44	19-29-49	23-34-54	27-40-58	30-44-62	34-46-66	38-49-69
		45°	6-12-30	10-20-39	15-25-44	20-30-49	23-34-52	26-39-56	30-42-59	33-44-63
18x10 22x08	Ac ft ²	CFM	332	442	553	663	774	884	995	1105
		NC	-	-	-	11	15	19	23	26
	Throw	0°	9-21-42	16-28-51	23-35-58	28-42-63	33-48-68	38-52-73	42-55-77	47-58-81
		22.5°	7-17-36	13-24-47	20-30-52	24-36-57	28-42-62	32-47-66	36-49-70	40-52-74
		45°	6-13-31	10-21-42	16-26-47	21-31-52	24-37-56	28-42-60	31-45-63	35-47-67
16x12 24x08	Ac ft ²	CFM	358	477	596	715	834	954	1073	1192
		NC	-	-	-	11	15	19	23	26
	Throw	0°	10-22-44	17-29-53	24-37-60	29-44-65	34-50-71	39-53-76	44-57-80	49-60-84
		22.5°	8-17-38	14-25-48	21-31-54	25-38-59	29-44-64	34-48-68	38-51-73	42-54-76
		45°	6-14-33	11-22-43	17-27-49	22-33-54	25-38-58	29-43-62	33-46-66	36-49-69
14x14 20x10	Ac ft ²	CFM	366	488	610	732	854	975	1097	1219
		NC	-	-	-	11	16	20	23	26
	Throw	0°	10-22-44	17-30-54	25-37-60	30-44-66	34-51-71	39-54-76	44-57-81	49-60-85
		22.5°	8-18-38	14-25-49	21-32-55	25-38-60	30-45-65	34-49-69	38-52-73	42-55-77
		45°	6-14-33	11-22-44	17-27-49	22-33-54	26-38-59	29-44-63	33-47-66	37-49-70
18x12 22x10	Ac ft ²	CFM	404	539	674	809	944	1078	1213	1348
		NC	-	-	-	11	16	20	23	27
	Throw	0°	10-23-47	18-31-57	26-39-64	31-47-70	36-53-75	41-57-80	47-60-85	52-64-90
		22.5°	8-18-40	15-27-51	22-33-57	27-40-63	31-47-68	36-51-73	40-55-77	45-58-81
		45°	6-15-35	12-23-46	18-29-52	23-35-57	27-40-62	31-46-66	35-49-70	38-52-74
15x15 16x14 28x08	Ac ft ²	CFM	423	564	705	846	987	1128	1269	1410
		NC	-	-	-	12	16	20	24	27
	Throw	0°	10-23-48	18-32-58	26-40-65	32-48-71	37-54-77	42-58-82	48-62-87	53-65-92
		22.5°	8-19-41	15-27-53	23-34-59	27-41-64	32-48-70	37-53-74	41-56-79	46-59-83
		45°	7-15-35	12-24-47	18-30-53	24-35-58	28-41-63	31-47-67	35-50-71	39-53-75
20x12 24x10 36x04	Ac ft ²	CFM	451	602	752	903	1053	1204	1354	1505
		NC	-	-	-	12	16	20	24	27
	Throw	0°	11-24-49	19-33-60	27-41-67	33-49-74	38-56-79	44-60-85	49-64-90	55-67-95
		22.5°	9-20-42	15-28-54	24-35-61	28-42-67	33-50-72	38-54-77	42-58-81	47-61-86
		45°	7-15-37	12-24-49	19-30-55	24-37-60	28-43-65	33-49-70	37-52-74	41-55-78

CONTINUED

SERIES XG-4100/XG-4200/XG-4300 PERFORMANCE DATA
MODELS XG-4100, XG-4200, XG-4300

Size	Pt	Nk Vel	300	400	500	600	700	800	900	1000
		0°	.012	.022	.034	.049	.067	.087	.110	.136
		22.5°	.015	.027	.043	.061	.084	.109	.138	.170
		45°	.021	.038	.059	.084	.115	.150	.190	.235
16x16 18x14	Ac ft ²	CFM	484	646	807	969	1131	1292	1454	1615
	1.61	NC	-	-	-	12	17	21	24	27
	Throw	0°	11 - 25 - 51	20 - 34 - 62	28 - 42 - 70	34 - 51 - 76	40 - 58 - 82	45 - 62 - 88	51 - 66 - 93	57 - 70 - 98
		22.5°	9 - 20 - 44	16 - 29 - 56	24 - 37 - 63	29 - 44 - 69	34 - 51 - 74	39 - 56 - 80	44 - 60 - 84	49 - 63 - 89
45°		7 - 16 - 38	13 - 25 - 51	20 - 32 - 57	25 - 38 - 62	29 - 44 - 67	34 - 51 - 72	38 - 54 - 76	42 - 57 - 81	
22x12 26x10	Ac ft ²	CFM	498	664	830	996	1162	1328	1494	1660
	1.66	NC	-	-	-	12	17	21	24	27
	Throw	0°	11 - 25 - 52	20 - 34 - 63	29 - 43 - 71	34 - 52 - 77	40 - 59 - 83	46 - 63 - 89	52 - 67 - 95	57 - 71 - 100
		22.5°	9 - 21 - 45	16 - 30 - 57	25 - 37 - 64	30 - 45 - 70	35 - 52 - 75	40 - 57 - 81	45 - 61 - 86	50 - 64 - 90
45°		7 - 16 - 38	13 - 26 - 51	20 - 32 - 58	26 - 38 - 63	30 - 45 - 68	34 - 51 - 73	38 - 55 - 77	43 - 58 - 82	
20x14 24x12 28x10 36x08	Ac ft ²	CFM	532	709	886	1063	1241	1418	1595	1772
	1.77	NC	-	-	-	13	17	21	25	28
	Throw	0°	12 - 26 - 53	21 - 36 - 65	30 - 45 - 73	36 - 53 - 80	42 - 61 - 86	47 - 65 - 92	53 - 69 - 98	59 - 73 - 103
		22.5°	9 - 21 - 46	17 - 31 - 59	26 - 38 - 66	31 - 46 - 72	36 - 54 - 78	41 - 59 - 83	46 - 63 - 88	51 - 66 - 93
45°		7 - 17 - 40	13 - 26 - 53	21 - 33 - 60	26 - 40 - 65	31 - 46 - 71	35 - 53 - 75	40 - 57 - 80	44 - 60 - 84	

PERFORMANCE NOTES FOR SERIES XG-4100, XG-4200, XG-4300

All data is tested in accordance with ANSI/ASHRAE 70-2006.

DEFINITION OF UNITS

CFM Cubic Feet per Minute (air)

Pt Total pressure (inches of water column)

Throw Throw distance in feet are for terminal velocities of 150 fpm, 100 fpm and 50 fpm respectively

NC Noise Criteria based on a room absorption of 10 dB, re: 10⁻¹² watts [NC les than 10 (-)]

Ac Actual Core Free Area in square feet

SERIES XG-4100/XG-4200/XG-4300 PERFORMANCE DATA
MODELS XG-4100, XG-4200, XG-4300

Size	Pt	Nk Vel	300	400	500	600	700	800	900	1000
		0°	.012	.022	.034	.049	.067	.087	.110	.136
		22.5°	.015	.027	.043	.061	.084	.109	.138	.170
		45°	.021	.038	.059	.084	.115	.150	.190	.235
30x10	Ac ft ²	CFM	564	752	940	1128	1316	1503	1691	1879
	1.88	NC	-	-	-	13	17	21	25	28
	Throw	0°	12-27-55	21-37-67	31-46-75	37-55-82	43-63-89	49-67-95	55-71-101	61-75-106
		22.5°	10-22-47	17-32-61	26-40-68	32-47-74	37-55-80	42-61-86	47-64-91	53-68-96
		45°	8-17-41	14-27-55	21-34-61	27-41-67	32-48-73	36-55-78	41-58-82	45-61-87
18x18 20x16	Ac ft ²	CFM	620	827	1033	1240	1447	1653	1860	2066
	2.07	NC	-	-	-	13	18	22	25	28
	Throw	0°	13-28-58	22-38-70	32-48-79	38-58-86	45-66-93	51-70-99	58-75-106	64-79-111
		22.5°	10-23-50	18-33-64	28-41-71	33-50-78	39-58-84	44-64-90	50-68-96	55-71-101
		45°	8-18-43	14-29-57	22-36-64	29-43-71	33-50-76	38-57-81	43-61-86	48-64-91
24x14 28x12 34x10	Ac ft ²	CFM	642	856	1070	1284	1498	1712	1926	2140
	2.14	NC	-	-	-	13	18	22	25	29
	Throw	0°	13-29-59	23-39-72	33-49-80	39-59-88	46-67-95	52-72-101	59-76-107	65-80-113
		22.5°	10-23-51	18-34-65	28-42-72	34-51-79	39-59-86	45-65-92	51-69-97	56-72-102
		45°	8-18-44	15-29-58	23-36-66	29-44-72	34-51-78	39-58-83	44-62-88	48-66-93
20x20 28x14	Ac ft ²	CFM	773	1030	1287	1544	1802	2059	2316	2573
	2.57	NC	-	-	-	14	19	23	26	29
	Throw	0°	14-32-64	25-43-79	36-54-88	43-64-96	50-73-104	57-79-111	64-83-118	72-88-124
		22.5°	11-26-56	20-37-71	31-46-79	37-56-87	43-65-94	49-71-100	55-75-107	62-79-112
		45°	9-20-48	16-32-64	25-40-72	32-48-79	37-56-85	43-64-91	48-68-96	53-72-102
22x20 24x14 26x12	Ac ft ²	CFM	851	1135	1420	1704	1989	2273	2557	2842
	2.84	NC	-	-	-	14	19	23	27	30
	Throw	0°	15-33-68	26-45-82	38-56-92	45-68-101	53-77-109	60-82-117	68-88-124	75-92-130
		22.5°	12-27-58	21-39-75	32-49-83	39-58-91	45-68-99	52-75-106	58-79-112	65-83-118
		45°	9-21-50	17-33-67	26-42-76	34-50-83	39-59-89	45-67-96	50-72-101	56-76-107
22x22 24x20 30x16	Ac ft ²	CFM	940	1254	1568	1881	2195	2509	2823	3136
	3.13	NC	-	-	-	15	19	23	27	30
	Throw	0°	15-35-71	28-47-87	39-59-97	47-71-106	55-81-115	63-87-123	71-92-130	79-97-137
		22.5°	13-28-61	22-41-78	34-51-88	41-61-96	48-71-104	54-78-111	61-83-118	68-88-124
		45°	10-22-53	18-35-70	28-44-79	35-53-87	41-62-94	47-70-100	53-75-106	59-79-112
24x24 32x18 36x16 48x12	Ac ft ²	CFM	1126	1502	1877	2253	2628	3004	3379	3755
	3.75	NC	-	-	-	16	20	24	28	31
	Throw	0°	17-38-78	30-52-95	43-65-106	52-78-116	60-89-125	69-95-134	78-101-142	86-106-150
		22.5°	14-31-67	24-45-86	37-56-96	45-67-105	52-78-114	60-86-121	67-91-129	74-96-136
		45°	11-24-58	19-39-77	30-48-87	39-58-95	45-67-103	51-77-110	58-82-116	64-87-123

CONTINUED

SERIES XG-4100/XG-4200/XG-4300 PERFORMANCE DATA
MODELS XG-4100, XG-4200, XG-4300

Size	Pt	Nk Vel	300	400	500	600	700	800	900	1000
		0°	.012	.022	.034	.049	.067	.087	.110	.136
		22.5°	.015	.027	.043	.061	.084	.109	.138	.170
		45°	.021	.038	.059	.084	.115	.150	.190	.235
26x26	Ac ft ²	CFM	1327	1770	2213	2656	3100	3543	3986	4429
	4.42	NC	-	-	11	16	21	25	28	32
28x24 48x14	Throw	0°	18-41-84	33-56-103	47-70-115	56-84-126	66-96-136	75-103-146	84-109-154	94-115-163
		22.5°	15-33-73	26-49-93	40-61-104	49-73-114	57-85-123	65-93-132	73-99-140	81-104-147
		45°	12-26-63	21-42-84	33-52-94	42-63-103	49-73-112	56-84-119	63-89-127	70-94-133
28x28 36x22 40x20 44x18	Ac ft ²	CFM	1545	2061	2576	3092	3608	4123	4639	5154
	5.15	NC	-	-	11	17	22	26	29	32
	Throw	0°	20-45-91	35-61-111	51-76-124	61-91-136	71-104-147	81-111-157	91-118-167	101-124-176
		22.5°	16-36-78	29-52-101	44-65-112	52-79-123	61-92-133	70-101-142	79-107-151	87-112-159
		45°	13-29-68	23-45-90	35-56-102	45-68-111	53-79-120	60-90-129	68-97-136	75-102-144
36x24 48x18	Ac ft ²	CFM	1710	2279	2848	3416	3985	4554	5123	5691
	5.70	NC	-	-	12	17	22	26	29	33
	Throw	0°	21-47-96	37-64-117	53-80-131	64-96-143	74-109-154	85-117-165	96-124-175	106-131-185
		22.5°	17-38-83	30-55-106	46-69-118	55-83-129	64-96-140	73-106-149	83-112-159	92-118-167
		45°	13-30-71	24-47-95	37-59-107	47-71-117	55-83-127	63-95-135	71-101-143	79-107-151

PERFORMANCE NOTES FOR SERIES XG-4100, XG-4200, XG-4300

All data is tested in accordance with ANSI/ASHRAE 70-2006.

DEFINITION OF UNITS

CFM Cubic Feet per Minute (air)

Pt Total pressure (inches of water column)

Throw Throw distance in feet are for terminal velocities of 150 fpm, 100 fpm and 50 fpm respectively

NC Noise Criteria based on a room absorption of 10 dB, re: 10⁻¹² watts [NC les than 10 (-)]

Ac Actual Core Free Area in square feet

SERIES XG-4100/XG-4200/XG-4300 PERFORMANCE DATA
MODELS XG-4100, XG-4200, XG-4300

Size	Pt	Nk Vel	300	400	500	600	700	800	900	1000
		0°	.012	.022	.034	.049	.067	.087	.110	.136
		22.5°	.015	.027	.043	.061	.084	.109	.138	.170
		45°	.021	.038	.059	.084	.115	.150	.190	.235
30x30 32x28	Ac ft ²	CFM	1785	2379	2973	3567	4162	4756	5350	5944
	5.95	NC	-	-	12	18	22	26	30	33
	Throw	0°	21-48-98	38-65-119	54-82-133	65-98-146	76-112-158	87-119-169	98-127-179	109-133-189
		22.5°	17-39-84	31-56-108	47-70-121	56-84-132	66-98-143	75-108-153	84-115-162	94-121-171
45°		14-31-73	24-49-97	38-61-109	49-73-120	57-85-129	65-97-138	73-104-147	81-109-155	
32x32	Ac ft ²	CFM	2034	2712	3390	4068	4746	5424	6102	6780
	6.78	NC	-	-	13	18	23	27	30	33
	Throw	0°	23-51-104	41-70-127	58-87-142	70-104-156	81-119-169	93-127-180	104-135-191	116-142-202
		22.5°	18-41-90	33-60-115	50-75-129	60-90-141	70-105-153	80-115-163	90-122-173	100-129-182
45°		15-33-78	26-52-104	41-65-117	52-78-128	60-91-138	69-104-148	78-111-157	86-117-165	
34x34 48x24	Ac ft ²	CFM	2300	3068	3837	4605	5373	6141	6910	7678
	7.67	NC	-	-	13	19	23	27	31	34
	Throw	0°	24-54-111	43-74-136	62-93-152	74-111-166	86-127-179	99-136-192	111-144-203	124-152-214
		22.5°	20-44-96	35-64-123	53-80-137	64-96-150	75-112-162	85-123-174	96-130-184	107-137-194
45°		15-35-83	28-55-110	43-69-124	55-83-136	64-96-147	73-110-157	83-118-167	92-124-176	
36x36	Ac ft ²	CFM	2590	3453	4315	5178	6040	6903	7765	8628
	8.63	NC	-	-	14	19	24	28	31	34
	Throw	0°	26-58-118	46-79-144	65-98-161	79-118-176	92-134-190	105-144-203	118-152-216	131-161-227
		22.5°	21-47-102	37-68-130	56-85-145	68-102-159	79-119-172	90-130-184	102-138-195	113-145-206
45°		16-37-88	29-58-117	46-73-132	58-88-144	68-102-156	78-117-167	88-125-177	97-132-186	
40x40	Ac ft ²	CFM	3210	4280	5350	6420	7490	8560	9630	10700
	10.67	NC	-	-	15	20	25	29	32	35
	Throw	0°	29-65-131	51-88-160	73-109-179	88-131-196	102-150-212	117-160-226	131-170-240	146-179-253
		22.5°	23-52-113	41-75-145	63-94-162	75-113-177	88-132-192	101-145-205	113-154-217	126-162-229
45°		18-41-98	33-65-130	51-81-147	65-98-161	76-114-173	87-130-185	98-139-197	108-147-207	
42x42	Ac ft ²	CFM	3528	4704	5880	7056	8232	9408	10584	11760
	11.76	NC	-	-	15	20	25	29	33	36
	Throw	0°	30-68-138	54-92-168	77-115-188	92-138-206	107-157-223	123-168-238	138-178-252	153-188-266
		22.5°	24-55-119	43-79-152	66-99-170	79-119-187	93-139-201	106-152-215	119-162-228	132-170-241
45°		19-43-103	34-68-137	54-86-154	68-103-169	80-120-182	91-137-195	103-146-207	114-154-218	
46x46 48x44	Ac ft ²	CFM	4230	5640	7050	8460	9870	11280	12690	14100
	14.10	NC	-	-	16	21	26	30	33	36
	Throw	0°	33-74-151	59-101-185	84-126-206	101-151-226	118-173-244	135-185-261	151-196-277	168-206-292
		22.5°	27-60-131	48-87-167	73-109-187	87-130-205	101-152-221	116-167-236	130-177-251	145-187-264
45°		21-48-113	38-75-150	59-94-169	75-113-185	88-131-200	100-150-214	112-160-227	125-169-239	

CONTINUED

SERIES XG-4100/XG-4200/XG-4300 PERFORMANCE DATA
MODELS XG-4100, XG-4200, XG-4300

Size	Pt	Nk Vel	300	400	500	600	700	800	900	1000
		0°	.012	.022	.034	.049	.067	.087	.110	.136
		22.5°	.015	.027	.043	.061	.084	.109	.138	.170
		45°	.021	.038	.059	.084	.115	.150	.190	.235
48x48	Ac ft ²	CFM	4608	6144	7680	9216	10752	12288	13824	15360
	15.36	NC	-	-	16	22	26	30	34	37
	Throw	0°	34-78-158	61-105-193	88-132-215	105-158-236	123-180-255	140-193-273	158-204-289	176-215-305
		22.5°	28-63-136	50-91-174	76-113-195	91-136-214	106-159-231	121-174-247	136-185-262	151-195-276
		45°	22-50-117	39-78-157	61-98-176	78-117-193	91-137-209	104-157-223	117-167-237	130-176-250

PERFORMANCE NOTES FOR SERIES XG-4100, XG-4200, XG-4300

All data is tested in accordance with ANSI/ASHRAE 70-2006.

DEFINITION OF UNITS

CFM Cubic Feet per Minute (air)

Pt Total pressure (inches of water column)

Throw Throw distance in feet are for terminal velocities of 150 fpm, 100 fpm and 50 fpm respectively

NC Noise Criteria based on a room absorption of 10 dB, re: 10⁻¹² watts [NC less than 10 (-)]

Ac Actual Core Free Area in square feet

INDUSTRIAL GRILLES

MODEL XG-RL

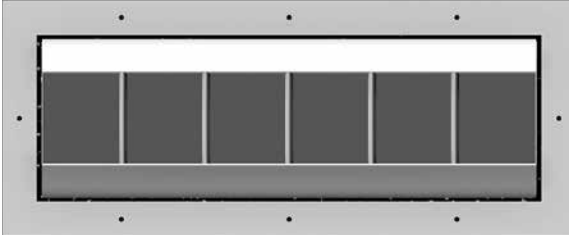

GREENHECK offers a complete line of industrial grilles for applications that require specialized performance or construction characteristics.

Aluminum Roto Louver Supply

The XG-RL series roto louver is designed to provide jet or diffused air patterns in ceiling, sidewall and exposed duct applications. The RL series is ideal for vertical spot cooling or heating when mounted in the ceiling or on the bottom of exposed ductwork.

- XG-RL – Cylindrical drum – Standard blades
- XG-RLDF – Cylindrical drum – Dual flow blades
- XG-RLG0 – Cylindrical drum – Standard blades – Gang operator

PAGE 185

MODEL XG-RL

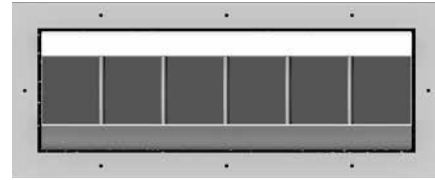

Air outlets shall be models XG-RL/XG-RL-DF/XG-RL-GO manufactured by GREENHECK. Units shall be vertical deflection blades mounted in a cylindrical drum and of extruded aluminum construction. The cylindrical drum shall rotate on non-metallic bushings and allow the discharge jet to be directed vertically within a 60° arc. Rotating drum shall be sealed with felt gasketing. Deflector blades shall be individually adjustable allowing the discharge jet to be adjusted horizontally 60°. The units shall be the size and quantity as outlined in the plans and specifications.

Model XG-RL-DF shall have split deflector blades along the center of the horizontal plane. Top and bottom deflector blades shall be individually adjustable.

Model XG-RL-GO shall include a gang operator to permit uniform adjustment of all deflector blades. Gang operator shall be accessible from the face of the outlet.

Optional opposed blade damper shall be constructed of aluminum (Model XG-DA).

Damper must be operable from the face of the register.

Performance Specification

The manufacturer shall provide published performance data. Data shall be tested in accordance to ANSI/ASHRAE Standard 70-2006.

Paint Specification

Process shall be anodic electro-deposition using an anodic acrylic paint. Units shall undergo pre-treatment including a pressurized spray stage using an alkaline cleaner and a de-ionized water rinse.

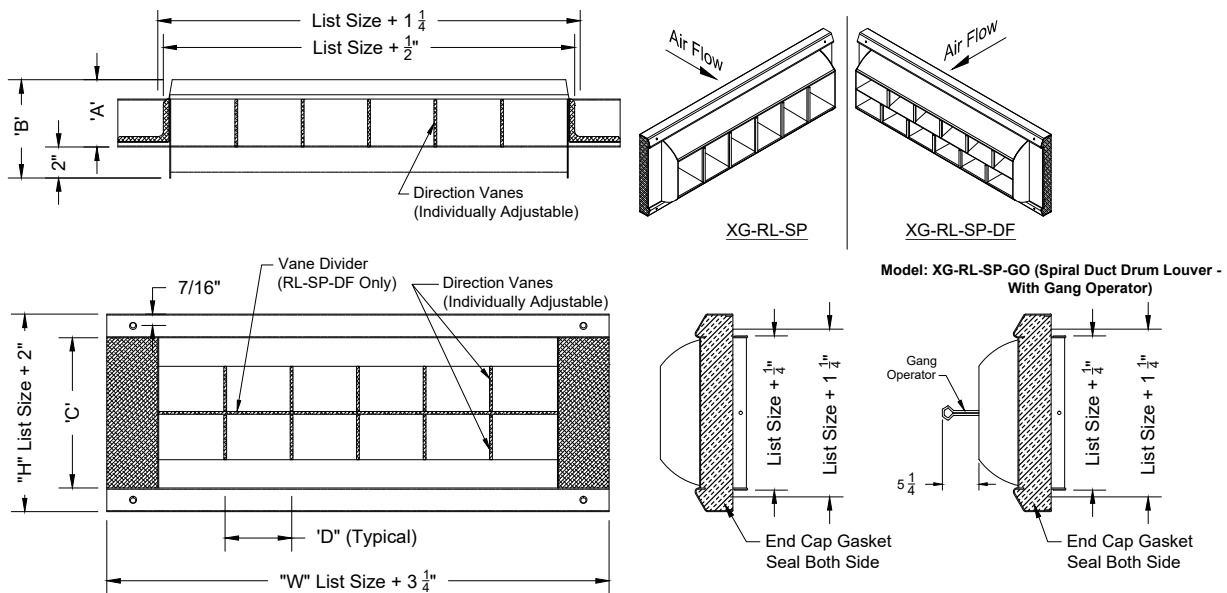

Available Listed Heights	6						10						12						15													
Available Listed Widths	9	12	18	24	30	36	48	60	20	25	30	35	40	50	60	70	20	25	30	35	40	50	60	70	15	20	25	30	40	50	60	70
Number of Louvers	2	3	5	7	9	11	15	19	3	4	5	6	7	9	11	13	3	4	5	6	7	9	11	12	2	3	4	5	7	9	11	13
A	1 3/4						2 5/8						3						3 1/2													
B	4 3/8						6 1/8						6 1/8						8													
C	3 1/2						5 7/8						6 1/4						9 1/2													
D	3						5						5						5													
E	8 1/2						12 1/4						13 7/8						16 7/8													
F	7						10 13/16						12 1/2						15 1/2													

XG-RL MODEL NUMBER SPECIFICATIONS

XG-RL ROTO LOUVER

Model		Neck															
XG-RL	Standard Blades	9	12	15	18	20	24	25	30	35	36	40	48	50	60	70	
XG-RL-DF	Dual Flow Blades	6	X	X	X	X		X		X		X		X		X	
XG-RL-GO	Standard Blades with Gang Operator	10					X		X	X	X		X		X	X	X
		12					X		X	X	X		X		X	X	X
		15			X		X		X	X			X		X	X	X

Available Finishes		Available Accessories	
Standard		XG-DA	Aluminum Opposed Blade Damper
04	Clear Anodized		
Optional			
01	White		
02	Satin Silver		
03	Black		
28	Custom Color		

SERIES XG-RL PERFORMANCE DATA
MODEL XG-RL

Size	Nk Vel	300	400	500	600	700	800	900	1000
	Pv	.006	.010	.016	.022	.031	.04	.050	.062
09x06	CFM	113	150	188	225	263	300	338	375
	Pt	.042	.075	.116	.168	.228	.298	.376	.465
	Throws	6-20	9-27	11-32	14-35	16-38	18-40	20-42	22-45
	NC	-	-	13	19	25	30	34	38
12x06	CFM	150	200	250	300	350	400	450	500
	Pt	.038	.068	.106	.152	.207	.271	.341	.422
	Throws	9-24	11-30	15-36	17-39	21-42	23-45	24-47	27-50
	NC	-	-	13	19	25	30	34	38
15x06	CFM	188	250	313	375	438	500	563	625
	Pt	.037	.063	.098	.141	.192	.250	.317	.391
	Throws	11-29	14-35	18-40	22-44	26-47	28-51	29-53	32-57
	NC	-	-	14	20	26	31	35	39
18x06	CFM	225	300	375	450	525	600	675	750
	Pt	.033	.059	.092	.133	.180	.236	.299	.369
	Throws	14-34	17-40	22-45	26-48	30-52	33-56	34-59	36-63
	NC	-	-	15	21	17	31	36	39
24x06	CFM	300	400	500	600	700	800	900	1000
	Pt	.030	.053	.083	.120	.164	.213	.271	.334
	Throws	17-39	23-45	28-51	32-56	35-60	36-64	40-68	41-72
	NC	-	-	14	20	25	30	35	38
30x06	CFM	375	500	625	750	875	1000	1125	1250
	Pt	.028	.049	.078	.112	.151	.198	.251	.309
	Throws	21-45	28-51	33-57	36-63	39-68	41-72	45-76	46-81
	NC	-	-	14	20	25	30	34	38
36x06	CFM	450	600	750	900	1050	1200	1350	1500
	Pt	.026	.047	.073	.105	.143	.186	.236	.291
	Throws	26-50	33-58	36-64	40-71	44-76	47-82	51-87	52-90
	NC	-	-	16	22	27	32	36	40
48x06	CFM	1000	1334	1667	2000	2334	2667	3000	3334
	Pt	.024	.043	.066	.095	.129	.169	.214	.264
	Throws	30-54	36-65	41-71	45-80	48-84	53-92	57-98	59-101
	NC	-	11	17	24	29	34	38	42

SERIES XG-RL PERFORMANCE DATA**MODEL XG-RL**

Size	Nk Vel	300	400	500	600	700	800	900	1000
	Pv	.006	.010	.016	.022	.031	.04	.050	.062
60x06	CFM	1250	1667	2084	2500	2917	3334	3750	4167
	Pt	.022	.039	.061	.088	.120	.157	.199	.244
	Throws	36-62	41-71	46-80	51-88	54-94	58-101	62-107	65-113
	NC	-	12	19	26	31	36	40	44

Data based on units tested at 0° Blade Deflection. See chart below for other Blade Deflections.

Deflection	NC	Throws	Pt
15°	+ 4	x .85	x 1.2
30°	+ 8	x .69	x 1.8

PERFORMANCE NOTES FOR SERIES XG-RL

All Data was tested in accordance with ANSI/ASHRAE 70-2006

DEFINITION OF UNITS:

CFM Air volume is cubic feet per minute

Nk Vel Neck Velocity is the airstream velocity in the duct just before it reaches the supply outlet; measured in feet per minute

NC Noise Criteria based on a room absorption of 10 dB, re: 10⁻¹² watts [NC less than 10 (-)]

Throw Throw distance in feet are for terminal velocities of 150 and 50 fpm respectively

Ps Static pressure is in inches of water

SERIES XG-RL PERFORMANCE DATA
MODEL XG-RL

Size	Nk Vel	300	400	500	600	700	800	900	1000
	Pv	.006	.010	.016	.022	.031	.04	.050	.062
20x10	CFM	417	556	695	834	973	1112	1250	1389
	Pt	.026	.047	.074	.107	.145	.189	.240	.292
	Throws	22-46	30-53	34-59	38-64	40-70	44-75	46-78	48-83
	NC	-	-	16	22	27	32	36	40
30x10	CFM	625	834	1042	1250	1459	1667	1875	2084
	Pt	.023	.042	.065	.094	.128	.167	.211	.261
	Throws	28-54	35-63	40-70	23-77	28-83	52-88	54-93	57-99
	NC	-	10	17	23	28	30	38	41
40x10	CFM	834	1112	1389	1667	1945	2223	2500	2778
	Pt	.021	.037	.058	.083	.114	.149	.188	.233
	Throws	34-63	41-72	46-81	52-90	57-96	60-101	63-107	65-114
	NC	-	11	18	24	29	32	39	42
50x10	CFM	1042	1389	1737	2084	2431	2778	3125	3473
	Pt	.019	.034	.053	.077	.105	.137	.173	.213
	Throws	41-71	47-82	53-92	58-101	63-108	68-116	71-123	75-130
	NC	-	12	29	25	31	36	40	44
60x10	CFM	1250	1667	2084	2500	2917	3334	3750	4167
	Pt	.018	.033	.051	.075	.101	.132	.167	.207
	Throws	44-77	51-90	58-100	63-111	69-119	74-126	77-135	82-142
	NC	-	13	20	26	31	37	40	45
70x10	CFM	1459	1945	2431	2917	3403	3889	4375	4862
	Pt	.017	.031	.049	.070	.095	.124	.157	.194
	Throws	48-84	57-98	63-108	69-119	75-129	80-137	84-146	89-153
	NC	-	14	21	27	32	37	41	45
20x12	CFM	500	667	834	1000	1167	1334	1500	1667
	Pt	.024	.043	.066	.095	.129	.169	.214	.264
	Throws	27-50	33-58	38-64	41-70	44-76	47-81	50-86	52-90
	NC	-	-	16	23	38	33	37	41
30x12	CFM	750	1000	1250	1500	1750	2000	2250	2500
	Pt	.022	.039	.061	.088	.120	.157	.199	.244
	Throws	34-60	40-70	45-77	48-84	52-92	57-98	59-104	62-110
	NC	-	11	18	24	29	34	38	42
40x12	CFM	1000	1334	1667	2000	2334	2667	3000	3334
	Pt	.019	.035	.054	.079	.108	.140	.178	.219
	Throws	40-70	47-81	52-90	57-99	62-106	66-113	70-120	74-128
	NC	-	12	19	25	31	35	40	43

SERIES XG-RL PERFORMANCE DATA**MODEL XG-RL**

Size	Nk Vel	300	400	500	600	700	800	900	1000
	Pv	.006	.010	.016	.022	.031	.04	.050	.062
50x12	CFM	1250	1667	2084	2500	2917	3334	3750	4167
	Pt	.018	.032	.050	.073	.098	.128	.163	.201
	Throws	45-77	52-89	57-100	63-108	68-74	74-125	77-134	81-141
	NC	-	13	20	26	31	36	41	44
60x12	CFM	1500	2000	2500	3000	3500	4000	4500	5000
	Pt	.017	.031	.485	.070	.095	.124	.157	.194
	Throws	50-84	57-98	63-110	69-118	74-130	81-137	84-147	90-154
	NC	-	14	21	27	32	37	42	45
70x12	CFM	1750	2334	2917	3500	4084	4667	5250	5834
	Pt	.016	.029	.046	.066	.089	.116	.147	.182
	Throws	53-92	62-106	69-118	75-130	81-141	87-150	92-159	96-167
	NC	-	15	22	28	33	38	42	46

Data based on units tested at 0° Blade Deflection. See chart below for other Blade Deflections.

Deflection	NC	Throws	Pt
15°	+ 4	x .85	x 1.2
30°	+ 8	x .69	x 1.8

PERFORMANCE NOTES FOR SERIES XG-RL

All Data was tested in accordance with ANSI/ASHRAE 70-2006

DEFINITION OF UNITS:

CFM Air volume is cubic feet per minute

Nk Vel Neck Velocity is the airstream velocity in the duct just before it reaches the supply outlet; measured in feet per minute

NC Noise Criteria based on a room absorption of 10 dB, re: 10⁻¹² watts [NC les than 10 (-)]

Throw Throw distance in feet are for terminal velocities of 150 and 50 fpm respectively

Ps Static pressure is in inches of water

SERIES XG-RL PERFORMANCE DATA
MODEL XG-RL

Size	Nk Vel	300	400	500	600	700	800	900	1000
	Pv	.006	.010	.016	.022	.031	.04	.050	.062
15x15	CFM	469	625	782	938	1094	1250	1407	1563
	Pt	.024	.044	.068	.097	.133	.173	.219	.271
	Throws	23-48	30-56	36-63	40-69	42-74	46-78	48-83	51-88
	NC	-	-	16	23	28	33	37	41
20x15	CFM	625	834	1042	1250	1459	1667	1875	2084
	Pt	.021	.042	.064	.092	.127	.165	.210	.257
	Throws	28-56	35-64	41-72	46-80	50-86	53-92	56-96	59-102
	NC	-	10	17	24	29	33	37	42
30x15	CFM	938	1250	1563	1875	2188	2500	2813	3125
	Pt	.020	.037	.057	.081	.112	.146	.184	.227
	Throws	33-63	40-72	47-82	53-90	57-98	60-105	63-110	68-117
	NC	-	11	18	25	30	34	38	43
35x15	CFM	1094	1459	1823	2188	2553	2917	3282	3646
	Pt	.019	.034	.053	.077	.105	.137	.173	.213
	Throws	39-70	46-81	19-92	59-101	64-110	68-118	71-123	76-131
	NC	-	12	19	26	30	35	39	43
40x15	CFM	1250	1667	2084	2500	2917	3334	3750	4167
	Pt	.030	.053	.083	.120	.164	.213	.271	.334
	Throws	17-39	23-45	28-51	32-56	35-60	36-64	40-68	41-72
	NC	-	-	14	20	25	30	35	38
50x15	CFM	1563	2084	2605	3125	3646	4167	4688	5209
	Pt	.017	.030	.047	.067	.091	.119	.154	.186
	Throws	51-87	58-100	65-112	71-123	77-132	82-142	87-150	92-159
	NC	-	14	21	27	32	37	41	45
60x15	CFM	1875	2500	3125	3750	4375	5000	5625	6250
	Pt	.016	.029	.045	.065	.088	.115	.146	.179
	Throws	56-95	64-110	71-122	78-134	84-144	89-154	95-165	100-176
	NC	-	14	22	28	33	38	42	46
70x15	CFM	2188	2917	3646	4375	5105	5834	6563	7292
	Pt	.016	.027	.043	.061	.083	.109	.137	.170
	Throws	59-102	69-118	76-132	84-144	90-156	96-167	102-178	108-186
	NC	-	15	23	28	34	39	43	47

CONTINUED

SERIES XG-RL PERFORMANCE DATA

MODEL XG-RL

Data based on units tested at 0° Blade Deflection. See chart below for other Blade Deflections.

Deflection	NC	Throws	Pt
15°	+ 4	x .85	x 1.2
30°	+ 8	x .69	x 1.8

PERFORMANCE NOTES FOR SERIES XG-RL

All Data was tested in accordance with ANSI/ASHRAE 70-2006

DEFINITION OF UNITS:

CFM Air volume is cubic feet per minute

Nk Vel Neck Velocity is the airstream velocity in the duct just before it reaches the supply outlet; measured in feet per minute

NC Noise Criteria based on a room absorption of 10 dB, re: 10^{-12} watts [NC les than 10 (-)]

Throw Throw distance in feet are for terminal velocities of 150 and 50 fpm respectively

Ps Static pressure is in inches of water

SPECIALTY GRILLES

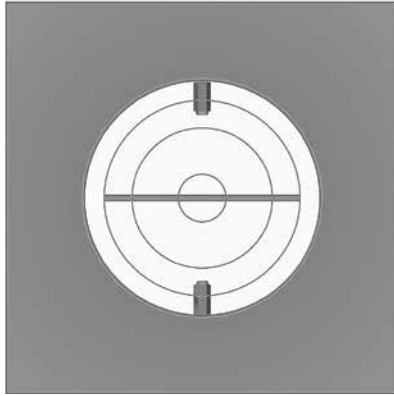
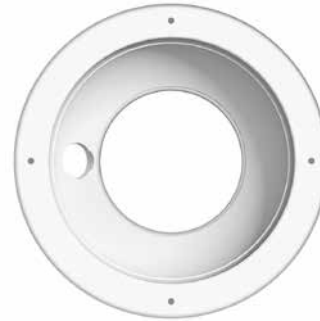
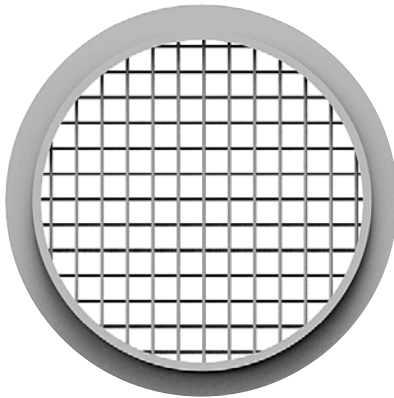
MODEL XG-JA

MODEL XG-MPK

MODEL XG-MRD

MODEL XG-WFO

GREENHECK has a complete line of specialty grilles for applications that require non-standard air distribution.

Steel/Aluminum Jet Aire High Capacity Nozzle

The Jet Aire high capacity industrial diffuser offers an economical solution to air distribution applications requiring long throws. They are ideal for spot heating or cooling in high traffic areas such as entrance ways and corridors.

- XG-JA – Steel – Single Unit
- XG-JA-AL – Aluminum – Single Unit
- XG-JA-EX – Steel – Single Unit for Exposed Duct
- XG-JA-AL-EX – Aluminum – Single Unit for Exposed Duct
- XG-JA-P – Steel – Panel Mounted
- XG-JA-AL-P – Aluminum – Panel Mounted
- XG-JA-LI – Steel – T-bar Lay-in Panel
- XG-JA-AL-LI – Aluminum – T-bar Lay-in Panel

Aluminum Punkah Louver

The Punkah Louver is designed for applications requiring a concentrated column of air. The adjustable nozzle allows greater control of the air stream for better air movement in poorly conditioned zones or dead air spaces.

- XG-MPK – Aluminum – Surface Mount
- XG-MPK-P – Aluminum – Panel Mounted
- XG-MPK-6 – Aluminum – T-bar Lay-in Panel

PAGE 205

Aluminum Round High Velocity Diffuser

The round high velocity diffusers combine superior performance and architectural appeal. The adjustable blades are designed to form a concentrated column of air or a widespread diffusion air pattern.

- XG-MRDD – Aluminum – Round Double Deflection – Supply
- XG-MRDW – Aluminum – Round Double Deflection – Wide Spacing – Supply
- XG-MRSD – Aluminum – Round Single Deflection – Supply
- XG-MREC – Aluminum – Round Egg Crate – Return

PAGE 209

Polymer Underfloor Diffuser

The polymer underfloor diffuser offers the choice of horizontal or vertical air patterns with its flip over design. The WFO is suitable for fitting into standard floor tile with optional fittings for concrete slab.

- XG-WFO – Polymer – Raised floor installation
- XG-WFOAL – Aluminum Face/Polymer Frame – Raised floor installation
- XG-WFOS – Polymer – Slab floor installation
- XG-WFOV – Polymer – Raised floor installation – Low pressure vertical supply
- XG-WFOI – Polymer – Raised floor installation – High induction

PAGE 213

MODEL XG-JA



Supply – Industrial/High Capacity Round Neck – Panel Mounted

XG-JA-1 Surface Mount – Single Unit

XG-JA-1P Panel Mounted – 1 Unit

XG- JA-2P Panel Mounted – 2 Units

XG-JA-3P Panel Mounted – 3 Units

XG-JA-4P Panel Mounted – 4 Units

Air Outlets shall be model XG-JA Jet*Aire by GREENHECK. Units shall be constructed of steel. The outlets shall consist of a core assembly constructed with a series of circular rings. The core shall be capable of adjustment from the face of the outlet without the use of special tools. The core assemble shall pivot on two nylon sleeved steel bolts. The core assembly shall be adjustable to obtain a full 60° arc along the vertical plane.

Options:

Units shall have a single core mounted in a square panel (model XG-JA-1) Units shall have two cores mounted in a rectangular panel (model XG-JA-2P) Units shall have three cores mounted in a rectangular panel (model XG-JA-3P) Units shall have four cores mounted in a rectangular panel (model XG-JA-4P)

The units shall be the size and quantity as outlined in the plans and specifications.

Units shall be designed for surface mounting applications and be provided with counter sunk screw holes on the face of the device.

MODEL XG-JA

Industrial / High Capacity - supply - Round Neck - Steel - Series XG-JA Jet-Aire

Models: **XG-JA-1EX** Jet* Aire Diffusers- Single Unit No Flange Duct Mount
XG-JA Jet* Aire Diffusers- Single Unit - Surface Mount

☐ XG-JA-1EX for exposed duct installation

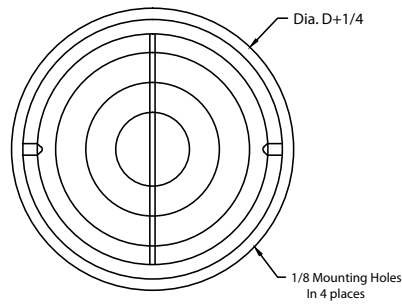
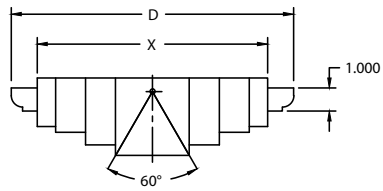

☐ XG-JA for surface mount installation

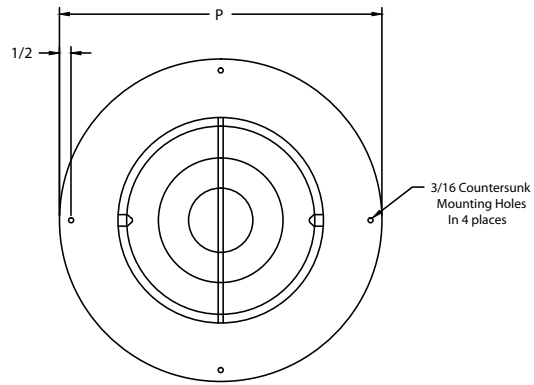
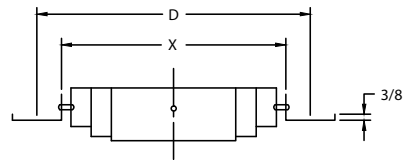

Model	X Element Diameter	Rings Per Element	Dia. D Duct Size
6	4	3	6
8	6	3	8
10	8	3	10
12	10	3	12
14	12	3	14
16	14	4	16
18	16	4	18
20	18	4	20
22	20	5	22
24	22	5	24

Model	X Element Diameter	Rings Per Element	Dia. D Duct Size	P Panel Diameter
6	4	3	6	8
8	6	3	8	10
10	8	3	10	12
12	10	3	12	14
14	12	3	14	16
16	14	4	16	18
18	16	4	18	20
20	18	4	20	22
22	20	5	22	24
24	22	5	24	26

MODEL XG-JA-AL

Neck - Aluminum- Series XG-JA Jet-Aire

Models: **XG-JA-AL-1EX** Jet* Aire Diffusers- Single Unit No Flange Duct Mount
XG-JA-AL Jet* Aire Diffusers- Single Unit - Surface Mount

XG-JA-AL-1EX for exposed duct installation

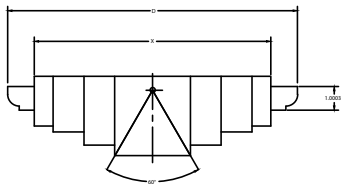

XG-JA-AL for surface mount installation

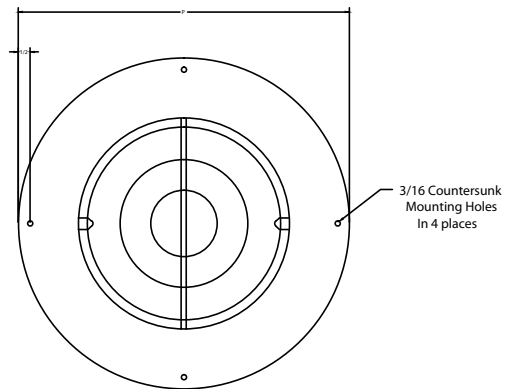
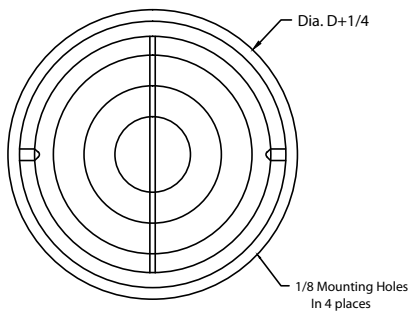
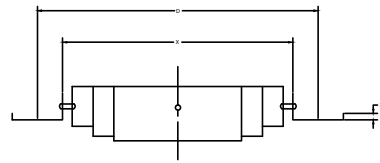

Model	X Element Diameter	Rings Per Element	Dia. D Duct Size
6	4	3	6
8	6	3	8
10	8	3	10
12	10	3	12
14	12	3	14
16	14	4	16
18	16	4	18
20	18	4	20
22	20	5	22
24	22	5	24

Model	X Element Diameter	Rings Per Element	Dia. D Duct Size	P Panel Diameter
6	4	3	6	8
8	6	3	8	10
10	8	3	10	12
12	10	3	12	14
14	12	3	14	16
16	14	4	16	18
18	16	4	18	20
20	18	4	20	22
22	20	5	22	24
24	22	5	24	26

MODEL XG-JA-LI

**Industrial / High Capacity - supply -
Round Neck - Square Lay-in Panel - Series XG-JA Jet-Aire**

Models: **XG-JA-LI** Jet* Aire Diffusers - Lay-in T-Bar - Square Panel - Steel Construction

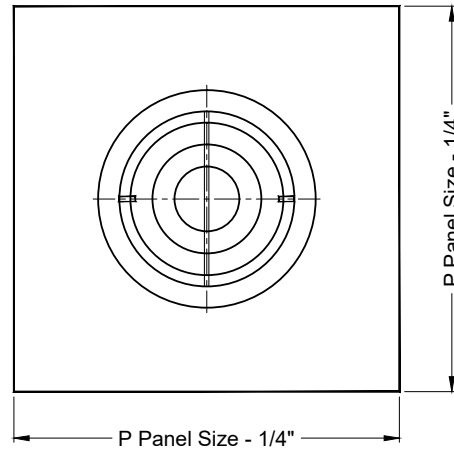
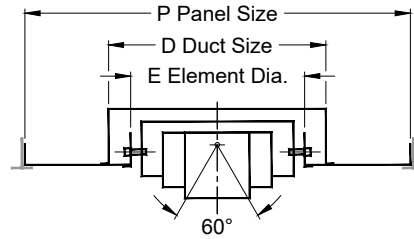

Model	E Element Diameter	Rings Per Element	Dia. D Duct Size	P Panel Size
08	6	3	8	24 x 24
10	8	3	10	24 x 24
12	10	3	12	24 x 24
14	12	3	14	24 x 24
16	14	4	16	24 x 24

XG-JA MODEL NUMBER SPECIFICATION
XG-JA-1, XG-JA-1EX, XG-JA-1P, XG-JA-2P, XG-JA-3P, JXG-A-4P

Model		Neck								Available Finishes	
		6	8	10	12	14	16	18	20		
XG-JA-1	Steel Single Unit Surface Mount	X	X	X	X	X	X	X	X	Standard	
XG-JA-AL-1	Aluminum Single Unit Surface Mount									01	White
XG-JA-1EX	Steel Single Unit for Exposed Duct									Optional	
XG-JA-AL-1EX	Aluminum Single Unit for Exposed Duct									02	Satin Silver
XG-JA-1P	Steel Single Unit Panel Mounted									03	Black
XG-JA-AL-1P	Aluminum Single Unit Panel Mounted									28	Custom Color
XG-JA-2P	Steel Two Units Panel Mounted										
XG-JA-AL-2P	Aluminum Two Units Panel Mounted										
XG-JA-3P	Steel Three Units Panel Mounted										
XG-JA-AL-3P	Aluminum Three Units Panel Mounted										
XG-JA-4P	Steel Four Units Panel Mounted										
JA-AL-4P	Aluminum Four Units Panel Mounted										

Model		Neck								Available Finishes	
		6	8	10	12	14	16	18	20		
XG-JA-LI-6	Steel T-bar Lay-in Panel	X	X	X	X	X	X			Standard	
XG-JA-AL-LI-6	Aluminum T-bar Lay-in Panel									01	White
										Optional	
										02	Satin Silver
										03	Black
										28	Custom Color

SERIES XG-JA PERFORMANCE**MODELS XG-JA, XG-A-1P, JA-2P, XG-JA-3P, XG-JA-4P**

Model	Nozzle Velocity (fpm)	573	860	1147	1433	1720	2007	2294
XG-JA-1EX-06 XG-JA-1EX-06 XG-JA-06 XG-JA-AL-06 XG-JA-1P-06 XG-JA-AL-1P-06 XG-JA-LI-06 XG-JA-LI-AL-06	CFM	50	75	100	125	150	175	200
	Throws	4-8-13	6-12-16	8-13-19	10-15-21	12-16-23	13-18-25	13-19-27
	PT	0.036	0.081	0.144	0.225	0.324	0.441	0.576
	NC	<20	<20	<20	25	30	35	39
XG-JA-2P-06 XG-JA-AL-2P-06	CFM	100	150	200	250	300	350	400
	Throws	6-11-19	9-16-23	11-19-27	14-21-30	16-23-33	18-25-36	19-27-38
	PT	0.036	0.081	0.144	0.225	0.324	0.441	0.576
	NC	<20	<20	21	28	33	38	42
XG-JA-3P-06 XG-JA-AL-3P-06	CFM	150	225	300	375	450	525	600
	Throws	7-14-23	11-20-29	14-23-33	18-26-37	20-29-40	22-31-44	23-33-47
	PT	0.036	0.081	0.144	0.225	0.324	0.441	0.576
	NC	<20	<20	23	30	35	40	44
XG-JA-4P-06 XG-JA-AL-4P-06	CFM	200	300	400	500	600	700	800
	Throws	8-16-27	12-23-33	16-27-38	20-30-43	23-33-47	25-36-50	27-38-54
	PT	0.036	0.081	0.144	0.225	0.324	0.441	0.576
	NC	<20	<20	24	31	36	41	45
Model	Nozzle Velocity (fpm)	714	917	1121	1352	1529	1733	1937
XG-JA-1EX-08 XG-JA-1EX-08 XG-JA-08 XG-JA-AL-08 XG-JA-1P-08 XG-JA-AL-1P-08 XG-JA-LI-08 XG-JA-LI-AL-08	CFM	140	180	220	260	300	340	380
	Throws	8-15-23	10-18-26	12-20-28	14-22-31	16-23-33	18-25-35	19-26-37
	PT	0.056	0.092	0.138	0.192	0.256	0.329	0.411
	NC	<20	<20	21	26	30	34	38
XG-JA-2P-08 XG-JA-AL-2P-08	CFM	280	360	440	520	600	680	760
	Throws	11-21-32	14-26-36	17-28-40	20-31-43	23-33-47	25-35-50	26-37-53
	PT	0.056	0.092	0.138	0.192	0.256	0.329	0.411
	NC	<20	<20	24	29	33	37	41
XG-JA-3P-08 XG-JA-AL-3P-08	CFM	420	540	660	780	900	1020	1140
	Throws	13-26-39	17-31-44	21-35-49	24-38-53	28-40-57	30-43-61	32-45-64
	PT	0.056	0.092	0.138	0.192	0.256	0.329	0.411
	NC	<20	20	26	31	35	39	42
XG-JA-4P-08 XG-JA-AL-4P-08	CFM	560	720	880	1040	1200	1360	1520
	Throws	15-30-45	19-36-51	24-40-57	28-43-61	32-47-66	35-50-70	37-53-74
	PT	0.056	0.092	0.138	0.192	0.256	0.329	0.411
	NC	<20	21	27	32	36	40	44

SERIES XG-JA PERFORMANCE
MODELS XG-JA, XG-JA-1P, XG-JA-2P, XG-JA-3P, XG-JA-4P

Model	Nozzle Velocity (fpm)	573	717	860	1003	1147	1290	1433
XG-JA-1EX-10 XG-JA-1EX-10 XG-JA-10 XG-JA-AL-10 XG-JA-1P-10 XG-JA-AL-1P-10 XG-JA-LI-10 XG-JA-LI-AL-10	CFM	200	250	300	350	400	450	500
	Throws	8-16-27	10-20-30	12-23-33	14-25-36	16-27-38	18-29-40	20-30-43
	PT	0.036	0.056	0.081	0.110	0.144	0.182	0.225
	NC	<20	<20	<20	20	24	28	31
XG-JA-2P-10 XG-JA-AL-2P-10	CFM	400	500	600	700	800	900	1000
	Throws	11-23-38	14-29-43	17-33-47	20-36-50	23-38-54	26-40-57	29-43-60
	PT	0.036	0.056	0.081	0.110	0.144	0.182	0.225
	NC	<20	<20	<20	23	27	31	34
XG-JA-3P-10 XG-JA-AL-3P-10	CFM	600	750	900	1050	1200	1350	1500
	Throws	14-28-47	18-35-52	21-40-57	25-44-62	28-47-66	32-49-70	35-52-74
	PT	0.036	0.056	0.081	0.110	0.144	0.182	0.225
	NC	<20	<20	20	25	29	32	36
XG-JA-4P-10 XG-JA-AL-4P-10	CFM	800	1000	1200	1400	1600	1800	2000
	Throws	16-32-54	20-40-60	24-47-66	28-50-71	32-54-76	36-57-81	40-60-85
	PT	0.036	0.056	0.081	0.110	0.144	0.182	0.225
	NC	<20	<20	21	26	30	34	37
Model	Nozzle Velocity (fpm)	550	734	917	1101	1284	1468	1651
XG-JA-1EX-12 XG-JA-1EX-12 XG-JA-12 XG-JA-AL-12 XG-JA-1P-12 XG-JA-AL-1P-12 XG-JA-LI-12 XG-JA-LI-AL-12	CFM	300	400	500	600	700	800	900
	Throws	10-19-33	13-26-38	16-30-43	19-33-47	23-36-50	26-38-54	29-40-57
	PT	0.033	0.059	0.092	0.133	0.181	0.236	0.299
	NC	<20	<20	<20	25	30	34	37
XG-JA-2P-12 XG-JA-AL-2P-12	CFM	600	800	1000	1200	1400	1600	1800
	Throws	14-27-47	18-37-54	23-43-60	27-47-66	32-50-71	37-54-76	40-57-81
	PT	0.033	0.059	0.092	0.133	0.181	0.236	0.299
	NC	<20	<20	22	28	32	37	40
XG-JA-3P-12 XG-JA-AL-3P-12	CFM	900	1200	1500	1800	2100	2400	2700
	Throws	17-34-57	22-45-66	28-52-74	34-57-81	39-62-87	45-66-93	49-70-99
	PT	0.033	0.059	0.092	0.133	0.181	0.236	0.299
	NC	<20	<20	24	30	34	38	42
XG-JA-4P-12 XG-JA-AL-4P-12	CFM	1200	1600	2000	2400	2800	3200	3600
	Throws	19-39-66	26-52-76	32-60-85	39-66-93	45-71-101	52-76-108	57-81-114
	PT	0.033	0.059	0.092	0.133	0.181	0.236	0.299
	NC	<20	20	25	31	35	40	43

SERIES XG-JA PERFORMANCE**MODELS XG-JA, XG-JA-1P, XG-JA-2P, XG-JA-3P, XG-JA-4P**

Model	Nozzle Velocity (fpm)	573	765	956	1147	1338	1529	1720
XG-JA-1EX-14 XG-JA-1EX-14 XG-JA-14 XG-JA-AL-14 XG-JA-1P-14 XG-JA-AL-1P-14 XG-JA-LI-14 XG-JA-LI-AL-14	CFM	450	600	750	900	1050	1200	1350
	Throws	12-24-40	16-32-47	20-37-52	24-40-57	28-44-62	32-47-66	35-49-70
	PT	0.036	0.064	0.100	0.144	0.196	0.256	0.324
	NC	<20	<20	22	28	32	39	40
XG-JA-2P-14 XG-JA-AL-2P-14	CFM	900	1200	1500	1800	2100	2400	2700
	Throws	17-34-57	23-46-66	29-52-74	34-57-81	40-62-87	46-66-93	49-70-99
	PT	0.036	0.064	0.100	0.144	0.196	0.256	0.324
	NC	<20	<20	21	28	33	38	42
XG-JA-3P-14 XG-JA-AL-3P-14	CFM	1350	1800	2250	2700	3150	3600	4050
	Throws	21-42-70	28-56-81	35-64-90	42-70-99	49-76-107	56-81-114	61-86-121
	PT	0.036	0.064	0.100	0.144	0.196	0.256	0.324
	NC	<20	<21	27	32	37	41	45
XG-JA-4P-14 XG-JA-AL-4P-14	CFM	1800	2400	3000	3600	4200	4800	5400
	Throws	24-49-81	32-65-93	40-74-104	49-81-114	57-87-123	65-93-132	70-99-140
	PT	0.036	0.064	0.100	0.144	0.196	0.256	0.324
	NC	<20	<22	28	34	38	42	46
Model	Nozzle Velocity (fpm)	562	749	936	1123	1311	1498	1685
XG-JA-1EX-16 XG-JA-1EX-16 XG-JA-16 XG-JA-AL-16 XG-JA-1P-16 XG-JA-AL-1P-16 XG-JA-LI-16 XG-JA-LI-AL-16	CFM	600	800	1000	1200	1400	1600	1800
	Throws	14-28-47	18-37-54	23-43-60	28-47-66	32-50-71	37-54-76	40-57-81
	PT	0.035	0.061	0.096	0.138	0.188	0.246	0.311
	NC	<20	<20	23	28	33	37	41
XG-JA-2P-16 XG-JA-AL-2P-16	CFM	1200	1600	2000	2400	2800	3200	3600
	Throws	20-39-66	26-52-76	33-60-85	39-66-93	43-71-101	52-76-108	57-81-114
	PT	0.035	0.061	0.096	0.138	0.188	0.246	0.311
	NC	<20	<20	26	31	36	40	44
XG-JA-3P-16 XG-JA-AL-3P-16	CFM	1800	2400	3000	3600	4200	4800	5400
	Throws	24-48-81	32-64-93	40-74-104	48-81-114	56-87-123	64-93-132	70-99-140
	PT	0.035	0.061	0.096	0.138	0.188	0.246	0.311
	NC	<20	22	28	33	38	42	45
XG-JA-4P-16 XG-JA-AL-4P-16	CFM	2400	3200	4000	4800	5600	6400	7200
	Throws	28-55-93	37-74-108	46-85-120	55-93-132	65-101-143	74-108-152	81-114-162
	PT	0.035	0.061	0.096	0.138	0.188	0.246	0.311
	NC	<20	23	29	34	39	43	47

SERIES XG-JA PERFORMANCE
MODELS XG-JA, XG-JA-1P, XG-JA-2P, XG-JA-3P, XG-JA-4P

Model	Nozzle Velocity (fpm)	538	717	896	1075	1245	1433	1613
XG-JA-1EX-18 XG-JA-1EX-18 XG-JA-18 XG-JA-AL-10 XG-JA-1P-18 XG-JA-AL-1P-18 XG-JA-LI-18 XG-JA-LI-AL-18	CFM	750	1000	1250	1500	1750	2000	2250
	Throws	15-30-52	20-40-60	25-48-67	30-52-74	35-56-80	40-60-85	45-64-90
	PT	0.032	0.056	0.088	0.127	0.172	0.225	0.285
	NC	<20	<20	23	28	33	37	40
XG-JA-2P-18 XG-JA-AL-2P-18	CFM	1500	2000	2500	3000	3500	4000	4500
	Throws	21-43-73	29-57-85	36-67-95	43-74-104	50-80-113	57-85-120	64-90-128
	PT	0.032	0.056	0.088	0.127	0.172	0.225	0.285
	NC	<20	20	26	31	36	40	43
XG-JA-3P-18 XG-JA-AL-3P-18	CFM	2250	3000	3750	4500	5250	6000	6750
	Throws	26-53-90	35-74-104	44-82-117	53-90-128	61-98-138	70-104-148	78-111-157
	PT	0.032	0.056	0.088	0.127	0.172	0.225	0.285
	NC	<20	22	27	33	38	42	45
XG-JA-4P-18 XG-JA-AL-4P-18	CFM	3000	4000	5000	6000	7000	8000	9000
	Throws	30-61-104	40-81-120	51-95-135	61-104-148	71-113-159	81-120-170	90-128-181
	PT	0.032	0.056	0.088	0.127	0.172	0.225	0.285
	NC	<20	23	29	34	39	43	46
Model	Nozzle Velocity (fpm)	566	736	906	1076	1246	1416	1586
XG-JA-1EX-20 XG-JA-1EX-20 XG-JA-20 XG-JA-AL-20 XG-JA-1P-20 XG-JA-AL-1P-20 XG-JA-LI-20 XG-JA-LI-AL-20	CFM	1000	1300	1600	1900	2200	2500	2800
	Throws	18-36-60	23-47-69	29-54-76	34-59-83	40-63-89	45-67-95	50-71-101
	PT	0.035	0.059	0.090	0.127	0.170	0.219	0.275
	NC	<20	<20	<20	29	34	38	41
XG-JA-2P-20 XG-JA-AL-2P-20	CFM	2000	2600	3200	3800	4400	5000	5600
	Throws	25-51-85	33-66-97	41-76-108	48-83-117	56-89-126	64-95-135	71-101-143
	PT	0.035	0.059	0.090	0.127	0.170	0.219	0.275
	NC	<20	22	27	32	34	41	44
XG-JA-3P-20 XG-JA-AL-3P-20	CFM	3000	3900	4800	5700	6600	7500	8400
	Throws	31-62-104	40-81-119	50-93-132	59-102-144	68-109-155	78-117-165	87-123-175
	PT	0.035	0.059	0.090	0.127	0.170	0.219	0.275
	NC	<20	24	29	34	38	42	46
XG-JA-4P-20 XG-JA-AL-4P-20	CFM	4000	5200	6400	7600	8800	10000	11200
	Throws	36-72-120	47-93-137	57-108-152	68-117-166	79-126-179	90-135-190	101-143-202
	PT	0.035	0.059	0.090	0.127	0.170	0.219	0.275
	NC	<20	25	30	35	40	44	47

SERIES XG-JA PERFORMANCE**MODELS XG-JA, XG-JA-1P, XG-JA-2P, XG-JA-3P, XG-JA-4P**

Model	Nozzle Velocity (fpm)	458	596	733	871	1008	1146	1283
XG-JA-1EX-22 XG-JA-AL-1EX-22 XG-JA-22 XG-JA-AL-22	CFM	1000	1300	1600	1900	2200	2500	2800
	Throws	16-33-60	21-42-69	26-52-76	31-59-83	36-63-89	41-67-95	46-71-101
	PT	0.025	0.042	0.064	0.090	0.120	0.160	0.200
	NC	<20	<20	<20	23	26	28	31
Model	Nozzle Velocity (fpm)	454	606	758	909	1061	1212	1364
XG-JA-1EX-24 XG-JA-AL-1EX-24 XG-JA-24 XG-A-AL-24	CFM	1200	1600	2000	2400	2800	3200	3600
	Throws	17-34-66	23-46-76	29-57-85	34-66-93	40-71-101	46-76-108	51-81-114
	PT	0.025	0.042	0.068	0.096	0.130	0.170	0.220
	NC	<20	<20	21	25	30	34	39
Model	Nozzle Velocity (fpm)	477	636	796	955	1114	1273	1432
XG-JA-1EX-26 XG-JA-AL-1EX-26 XG-JA-26 XG-JA-AL-26	CFM	1500	2000	2500	3000	3500	4000	4500
	Throws	20-40-74	27-53-85	33-67-95	40-74-104	47-80-113	53-85-120	60-90-128
	PT	0.028	0.046	0.070	0.110	0.140	0.190	0.230
	NC	>20	>20	22	27	32	37	42

PERFORMANCE NOTES FOR SERIES XG-JA

All Data was tested in accordance with ANSI/ASHRAE 70-2006

DEFINITION OF UNITS:

CFM Airflow / Standard air density and isothermal conditions.

NC Noise Criteria [NC] curve which is not exceeded with a Room Attenuation of 10dB and based on power Level RE: 10^{-12} watts

Pt Total Pressure [Pt] Inches of water gauge required.

Throws Projection distance [Throw] in feet from the Nozzle discharge at which the maximum velocity has been reduced to specified terminal velocity [Vt]. 150 (fpm), 100 (fpm) & 50 (fpm)

Nk Vel Nozzle Discharge Velocity in feet per minute [fpm].

Vt Terminal Velocity, Maximum Velocity [Vt] in feet per minute [fpm] at the specified distance from the outlet face [Throw] 200 fpm, 100 fpm and 50 fpm respectively.

MODEL XG-MPK

Supply Unit Specification

Air Outlets shall be Greenheck XG-MPK Punkah Louver Diffusers manufactured by GREENHECK. Units shall be composed of an adjustable inner round nozzle section and a round outer frame. The units shall be the size and quantity as outline in the plans and specifications.

Unit shall be manually adjustable without the use of tools allowing the discharge jet to be directed a full 70 degrees. Outlet shall be constructed using a felt gasket seal providing smooth adjustment without leakage. Outer circular frame of unit shall include a closed cell neoprene gasket to prevent leakage between the outlet and mounting surface.

Optional Aperture Damper

Outlets shall include an integral aperture damper. Damper shall have an adjustment knob constructed from aluminum. Connecting linkage, tension springs, and damper hardware shall be constructed from stainless steel.

Outlets shall be constructed of heavy gauge aluminum and available in 6", 8", 10", 12", 14", 16", 18", and 20" diameters.

Performance Specification

The manufacturer shall provide published performance data. Data shall be tested in accordance to ANSI/ASHRAE Standard 70- 2006



MODEL XG-MPK

Industrial High Capacity Punkah Louver Aluminum - Global Adjustment

Models: **XG-MPK** Punkah Louver

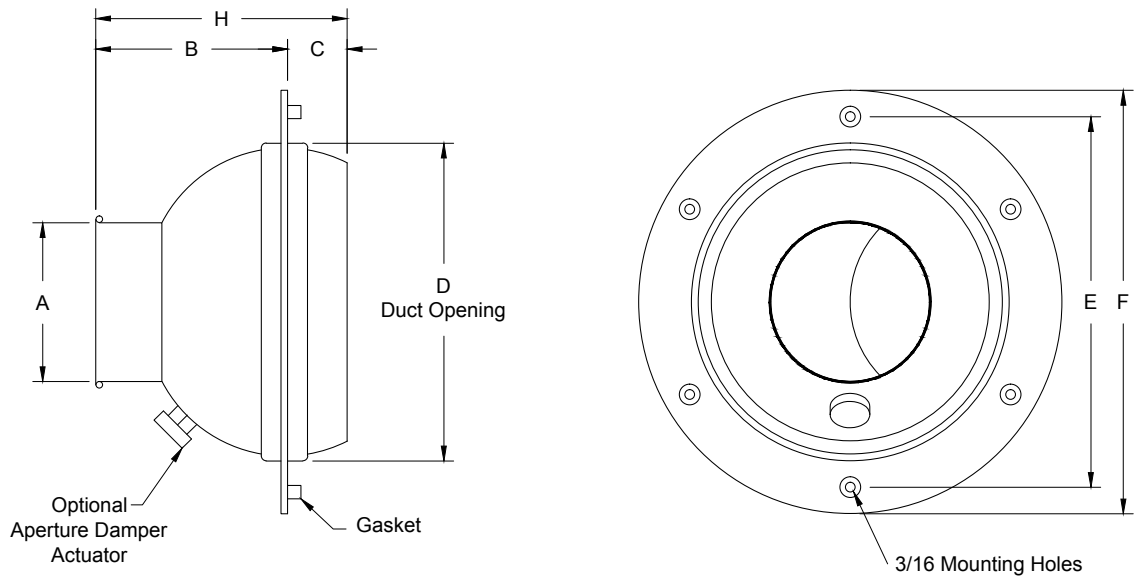

SIZE	A	B	C	D	E	F	H	No. of Mtg Holes
6	3	3-5/8	1-1/8	6	7	8	4-3/4	4
8	4-3/8	4-5/8	1-3/4	8	9	10	6-1/8	4
10	5-3/4	6-1/4	2-1/2	10	11	12	8-3/4	6
12	7-3/8	6-1/2	3	12	13	14	9-1/2	6
14	8-5/8	7-3/8	4-1/8	14	15	16	11-1/2	6
16	9-3/4	8-1/2	4-5/8	16	17	18	13-1/8	6
18	10-1/2	10	4-5/8	18	19	20	14-5/8	8
20	12-3/8	11	5	20	21	22	16	8

XG-MPK MODEL NUMBER SPECIFICATION
XG-MPK PUNKAH LOUVER

Model		Neck								Available Finishes	
		6	8	10	12	14	16	18	20		
XG-MPK	Aluminum Surface Mount	X	X	X	X	X	X	X	X	Standard	
XG-MPK-2P	Aluminum Two Units Panel Mounted	X	X	X	X					24	Mill
XG-MPK-4P	Aluminum Four Units Panel Mounted	X	X	X	X					Optional	
XG-MPK-6	Aluminum T-bar Lay-in	X	X	X	X					01	White
										02	Satin Silver
										03	Black
										04	Clear Anodized
										28	Custom Color

PERFORMANCE NOTES FOR SERIES XG-MPK

All data is tested in accordance with ANSI/ASHRAE 70-2006.

DEFINITION OF UNITS

CFM	Airflow / Standard air density and isothermal conditions.
NC	Noise Criteria [NC] curve which is not exceeded with a Room Attenuation of 10dB and based on Sound Power Level RE: 10 ⁻¹² watts
Total Pressure	Inches of water gauge required.
Projection	Projection distance {Throw} in feet from the Nozzle discharge at which the maximum velocity has been reduced to specified terminal velocity [Vt].
Nozzle Velocity	Nozzle Discharge Velocity in feet per minute [fpm].
Terminal Velocity	Maximum velocity [Vt] in feet per minute [fpm] at the specified distance from the outlet face [Throw] 400 fpm, 200 fpm and 100 fpm respectively.

SERIES XG-MPK PERFORMANCE DATA
MODEL XG-MPK

Model	Nozzle Velocity (fpm)	1000	1500	2000	2500	3000	3500	4000
XXG-MPK-04	CFM	22	33	44	55	66	77	88
	Projection	3-6-12	4-8-17	6-12-23	8-16-24	9-18-27	10-21-30	12-22-32
	Total Pressure	0.03	0.07	0.13	0.20	0.28	0.39	0.50
	NC	<15	<15	<15	19	23	26	30
XG-MPK-06	CFM	49	74	98	123	147	172	196
	Projection	4-8-16	6-12-23	8-16-27	10-20-30	12-21-32	14-25-36	16-26-38
	Total Pressure	0.05	0.12	0.22	0.34	0.49	0.66	0.86
	NC	<15	<15	15	21	25	29	33
XG-MPK-08	CFM	104	157	209	261	313	365	418
	Projection	6-11-23	8-17-34	11-23-39	14-28-44	17-31-46	20-35-52	23-38-55
	Total Pressure	0.06	0.14	0.24	0.38	0.53	0.70	0.92
	NC	<15	<15	17	24	30	35	38
XG-MPK-10	CFM	180	270	261	451	541	631	721
	Projection	7-15-30	11-22-45	15-30-51	19-37-57	22-41-61	26-47-69	30-50-72
	Total Pressure	0.07	0.15	0.25	0.39	0.56	0.74	0.96
	NC	<15	<15	21	29	35	40	45
XG-MPK-12	CFM	297	445	593	742	890	1038	1187
	Projection	10-19-38	14-29-57	19-38-65	24-48-74	29-52-78	33-60-88	38-64-93
	Total Pressure	0.07	0.15	0.26	0.40	0.58	0.78	1.01
	NC	<15	15	24	32	38	44	47
XG-MPK-14	CFM	406	609	811	1014	1217	1420	1623
	Projection	11-22-45	17-33-67	22-44-76	28-56-86	33-61-91	39-70-103	45-75-108
	Total Pressure	0.07	0.15	0.26	0.41	0.58	0.79	1.02
	NC	<15	15	25	33	39	44	48
XG-MPK-16	CFM	518	778	1036	1296	1555	1815	2074
	Projection	13-25-50	19-38-76	25-50-86	32-63-97	38-69-103	44-79-117	50-84-122
	Total Pressure	0.07	0.14	0.26	0.41	0.58	0.80	1.03
	NC	<15	16	26	33	39	44	49
XG-MPK-18	CFM	601	902	1202	1503	1804	2105	2406
	Projection	14-27-54	20-41-81	27-54-110	34-68-105	41-74-111	47-85-126	54-91-132
	Total Pressure	0.06	0.13	0.24	0.37	0.54	0.74	0.96
	NC	<15	16	26	33	39	44	49
XG-MPK-20	CFM	835	1253	1670	2088	2506	2924	3341
	Projection	16-32-64	24-48-96	32-64-110	40-80-123	48-87-131	56-100-148	64-107-155
	Total Pressure	0.06	0.12	0.22	0.34	0.49	0.68	0.88
	NC	<15	17	27	34	40	46	51

MODEL XG-MRD

Supply – Single Deflection/

XG-MRDS

Air Outlets shall be model XG-MRDS by GREENHECK. Units shall be a round, single deflection supply register with 1” extruded aluminum airfoil shaped blades on 1” spacing. Border shall be constructed of heavy gauge aluminum. Deflector blades shall be individually adjustable.

Units shall be designed for concealed mounting in either wall or ceiling applications and allow installation for both hard and flexible ductwork. Units shall also include a foam gasket to seal the border and mounting surface.

The units shall be the size and quantity as outlined in the plans and specifications.

Supply – Double Deflection/

XG-MRDD

Air Outlets shall be model XG-MRDD by GREENHECK. Units shall be a round, double deflection supply register with a set of front and perpendicular rear deflection blades. Deflection blades shall be 1” extruded aluminum airfoil shaped blades on 1” spacing. Border shall be constructed of heavy gauge aluminum. Deflector blades shall be individually adjustable.

Units shall be designed for concealed mounting and allow installation for both hard and flexible ductwork. Units shall also include a foam gasket to seal the border and mounting surface.

The units shall be the size and quantity as outline in the plans and specifications.

Performance Specification

The manufacturer shall provide published performance data. Data shall be tested in accordance to ANSI/ASHRAE Standard 70- 2006

XG-MRD MODEL NUMBER SPECIFICATION

Model		Neck										Available Finishes	
XG-MRDD	Round Double Deflection	6	8	10	12	14	16	18	20	22	24	Standard	
XG-MRDW	Round Double Deflection- Wide Spacing	X	X	X	X	X	X	X	X	X	X	01	White
XG-MRSD	Round Single Deflection											Optional	
XG-MREC	Round Egg Crate											02	Satin Silver
												03	Black
												24	Mill
												28	Custom Color

MODEL XG-MRD

Industrial High Capacity Devices
Aluminum Construction - Round

Models: **XG-MRSD** Single Deflection Grille - Wall or Ceiling Mount - Adjustable Air Pattern
 XG-MRDD Double Deflection Grille - Wall or Ceiling Mount - Adjustable Horizontal / Vertical Blades

Model: XG-MRSD (Single Deflection Grille - Wall or Ceiling - Adjustable Air Pattern)

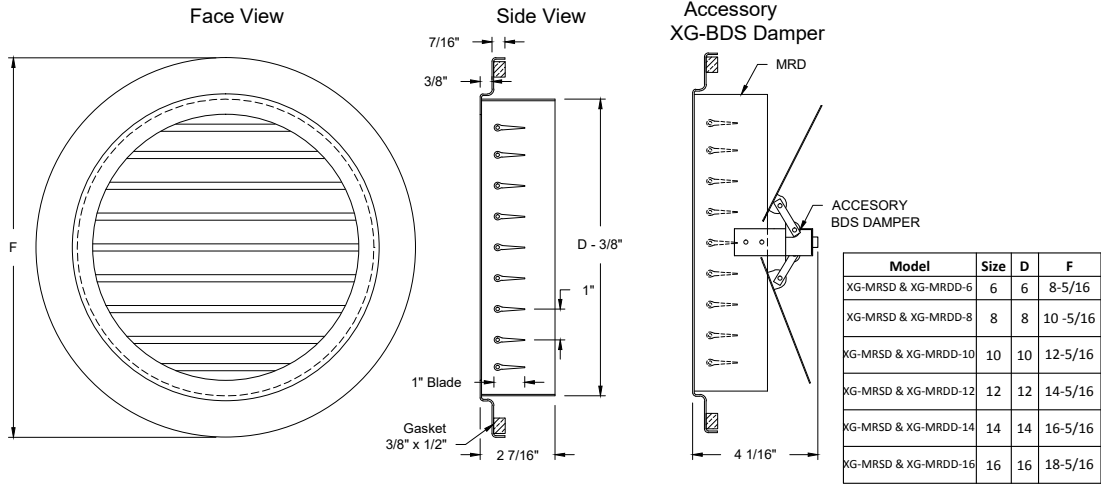

Model: XG-MRDD (Double Deflection Grille - Wall or Ceiling - Adjustable Horizontal / Vertical Blades)

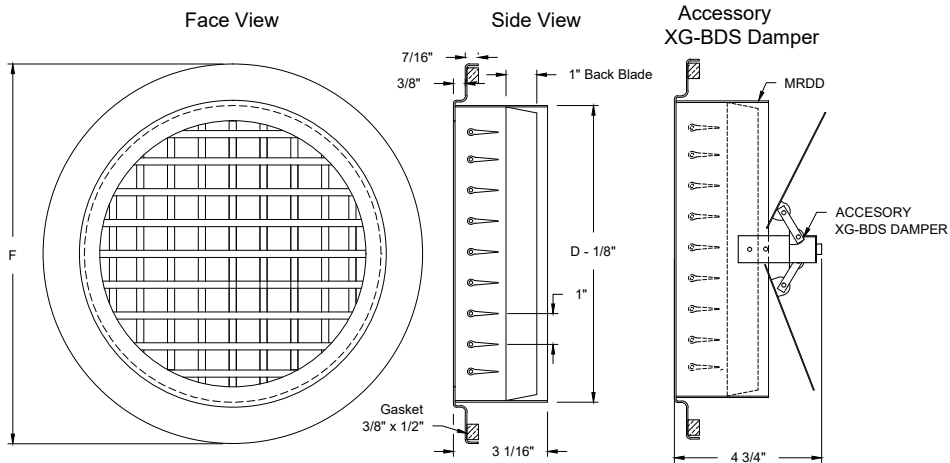

SERIES XG-MRD PERFORMANCE DATA
MODELS XG-MRSD/XG-RDD/XG-MRDW

Size	fpm	400	600	800	1000	1200	1400	1600
	Pv	.010	.022	.040	.062	.090	.122	.160
6	CFM	79	118	157	196	236	275	314
	Ps	.021	.047	.073	.133	.185	.254	.322
	NC	<15	<15	15	23	29	35	40
	Throw	4-8-15	6-12-21	8-14-24	10-16-28	13-21-30	15-22-32	17-24-34
8	CFM	140	209	279	349	419	489	559
	Ps	.016	.038	.067	.105	.150	.205	.266
	NC	<15	<15	<15	21	27	33	38
	Throw	5-10-20	8-16-27	11-21-32	14-25-36	17-28-39	20-30-41	21-32-45
10	CFM	218	327	436	545	655	764	873
	Ps	.014	.033	.059	.092	.131	.180	.234
	NC	<15	<15	<15	20	26	32	36
	Throw	6-12-24	9-17-32	14-26-37	17-31-45	21-34-47	25-37-52	29-40-56
12	CFM	314	471	628	786	943	1100	1257
	Ps	.014	.031	.053	.085	.120	.165	.213
	NC	<15	<15	<15	19	25	31	35
	Throw	7-15-30	12-24-40	16-33-47	20-37-53	25-41-59	29-45-65	33-48-74
14	CFM	428	641	855	1069	1283	1497	1711
	Ps	.013	.029	.050	.077	.114	.154	.201
	NC	<15	<15	<15	19	25	31	35
	Throw	8-18-37	14-28-17	18-38-55	23-44-61	30-48-70	34-52-74	38-56-83
16	CFM	559	838	1117	1396	1676	1955	2234
	Ps	.013	.027	.048	.076	.108	.147	.191
	NC	<15	<15	<15	19	25	31	35
	Throw	10-20-40	15-30-53	22-44-65	28-50-72	34-54-80	40-60-85	45-64-90
18	CFM	707	1060	1414	1767	2121	2474	2828
	Ps	.012	.027	.046	.072	.104	.142	.185
	NC	<15	<15	<15	20	26	32	36
	Throw	11-22-44	18-36-61	25-50-72	31-57-80	40-63-89	45-67-95	50-71-101
20	CFM	873	1309	1746	2182	2618	3055	3491
	Ps	.012	.026	.045	.070	.101	.137	.177
	NC	<15	<15	<15	20	26	32	36
	Throw	12-24-49	20-40-68	27-53-80	35-63-89	44-68-99	51-74-105	56-78-112
22	CFM	1056	1584	2112	2640	3168	3696	4224
	Ps	.011	.025	.043	.068	.097	.133	.173
	NC	<15	<15	<15	21	27	33	37
	Throw	13-27-54	22-44-74	30-57-85	37-68-98	47-76-110	57-85-120	60-87-123
24	CFM	1257	1885	2514	3142	3770	4399	5027
	Ps	.011	.024	.042	.068	.096	.130	.170
	NC	<15	<15	15	22	29	34	38
	Throw	14-29-60	24-48-81	33-66-95	41-75-106	50-84-116	58-88-124	66-95-130

SERIES XG-MRD PERFORMANCE DATA
MODEL XG-MREC

Size	fpm	400	600	800	1000	1200	1400	1600
	Pv	.010	.022	.040	.062	.090	.122	.160
6	CFM	79	118	157	196	236	275	314
	Ps	.040	.091	.162	.255	.363	.500	.652
	NC	<15	22	32	39	45	50	54
8	CFM	140	209	279	349	419	489	559
	Ps	.036	.080	.142	.223	.320	.432	.568
	NC	<15	22	31	38	44	49	53
10	CFM	218	327	436	545	655	764	873
	Ps	.033	.073	.130	.203	.293	.397	.522
	NC	<15	22	31	38	44	48	52
12	CFM	314	471	628	786	943	1100	1257
	Ps	.031	.070	.123	.194	.278	.384	.495
	NC	<15	22	32	38	45	49	53
14	CFM	428	641	855	1069	1283	1497	1711
	Ps	.030	.067	.119	.186	.267	.365	.475
	NC	<15	23	32	39	45	50	54
16	CFM	559	838	1117	1396	1676	1955	2234
	Ps	.029	.065	.116	.181	.260	.354	.465
	NC	<15	23	33	40	45	50	54
18	CFM	707	1060	1414	1767	2121	2474	2828
	Ps	.028	.064	.114	.177	.255	.346	.454
	NC	<15	23	33	40	45	50	54
20	CFM	873	1309	1746	2182	2618	3055	3491
	Ps	.028	.063	.111	.174	.250	.342	.446
	NC	<15	25	35	41	47	52	56
22	CFM	1056	1584	2112	2640	3168	3696	4224
	Ps	.027	.061	.110	.171	.246	.336	.439
	NC	<15	25	35	41	47	52	56
24	CFM	1257	1885	2514	3142	3770	4399	5027
	Ps	.027	.061	.108	.170	.244	.331	.435
	NC	<15	25	35	41	47	52	56

PERFORMANCE NOTES FOR SERIES XG-MREC/XG-MRD

All data is tested in accordance with ANSI/ASHRAE 70-2006.

DEFINITION OF UNITS

CFM Cubic Feet per Minute (air)

fpm Velocity of air stream in Feet per Minute

Ps Static pressure = $P_t - P_v$ (inches of water column)

Throw Non-isothermal horizontal throw (supply air temperature 15°F colder than average room temperature); values are for 50, 100 and 200fpm velocities

NC Noise criterion, sound pressure level NC ratings are based on sound power level (Lw) re: 10^{-12} watts minus a 10dB room attenuation in all octave bands

Pv Velocity pressure (inches of water column)

MODEL XG-WFO

The XG-WFO polymer Underfloor diffuser offers the choice of horizontal or vertical air patterns with its flip over design. The XG-WFO is suitable for fitting into standard floor tile with optional fittings for concrete slab. The disc is reversible for horizontal or vertical air throw. The diffuser has a memory peg feature to retain damper setting once commissioned.

- Polymer construction
- Fire retardant material
- Standard color RAL 7037 Mid Grey
- Unique flip over design
- Memory locating peg
- Easy fit locking collar
- Available in 8" only

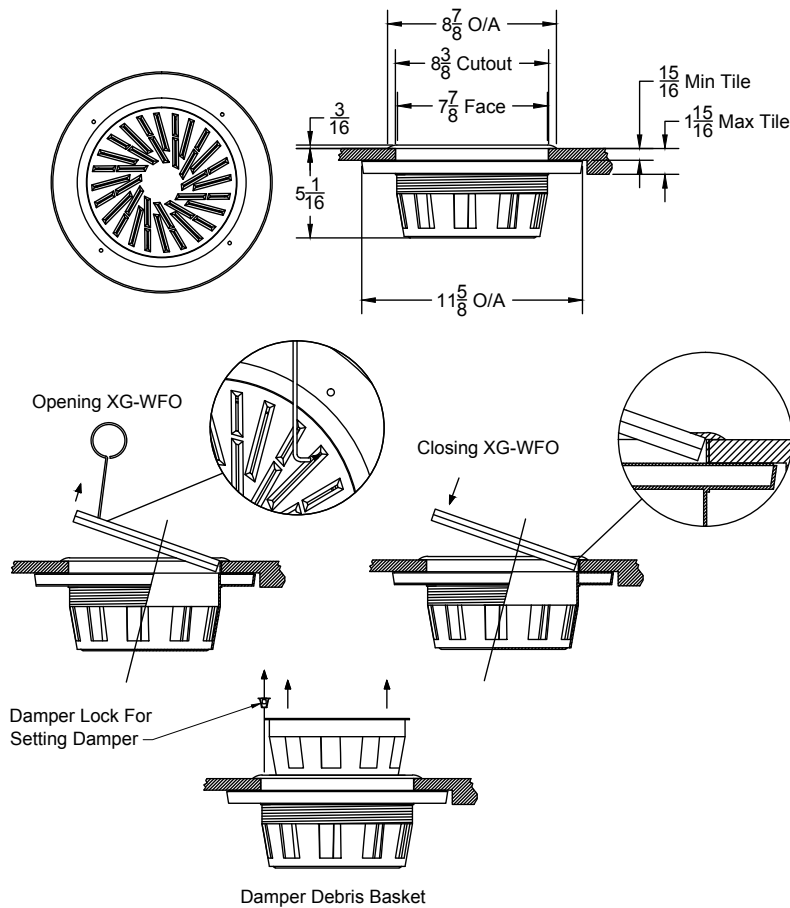

SECURITY GRILLES

MAXIMUM SECURITY GRILLES
MODEL XG-SGRP



MEDIUM SECURITY GRILLES
MODEL XG-SGRH



SECURITY ACCESSORIES/OPTIONS
MODEL XG-SGLFO

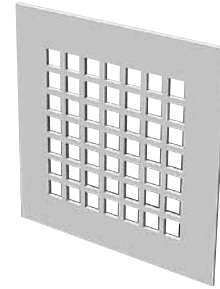

MINIMUM SECURITY GRILLES
MODEL XG-SG5500



BARRIER GRILLES
MODEL XG-SGDB



Security Grilles

Greenheck offers a complete line of security grilles from minimum to maximum security.

Greenheck security grilles are designed to provide efficient air distribution without jeopardizing safety or security. Security grilles main application is correctional facilities, however, they are also an excellent choice for schools, psychiatric hospitals, manufacturing plants or anywhere that extra security is required.

Maximum Security Grilles

The maximum security grilles are designed for high security applications such as prisoner cells and isolated areas in correctional institutions where there is minimum or no supervision.

- XG-SGSP – 2" Square holes – Mesh face
- XG-SGRP – 5/16" Round holes – Perforated face
- XG-SGRP-SR – 3/16" Round holes – Perforated face

PAGE 216

Medium Security Grilles

The medium security grilles are designed for high volume areas such as dining and exercise areas in correctional institutions, manufacturing plants and psychiatric hospitals.

- XG-SGRH – Fixed louvered face return – 14 gauge steel – 0° or 40° deflection
- XG-SGWM – Woven wire mesh – 12 gauge steel – 3/8" woven mesh

PAGE 232

Minimum Security Grilles

The minimum security grilles are designed for minimum security areas in correctional institutions, manufacturing plants and psychiatric hospitals. They are also an excellent choice for public areas to resist vandalism.

- XG-SG5500S – Louvered/Lattice face
- XG-SGRP-AL – 5/16" Round holes – Perforated face – Aluminum
- XG-SGRP-SR-AL – 3/16" Round holes – Perforated face – Aluminum
- XG-SG2000 – Reinforced bar grille – Aluminum
- XG-SGLF – Lattice face

PAGE 244

Barrier Grilles

The barrier grille is designed as a barrier for opening between secure and non-secure areas. These grilles are for duct/wall mounted applications.

- XG-SGDB – Duct bar welded in sleeve
- XG-SGDF – Duct bar welded in flat mounting frame
- XG-SGDFF – Duct bar welded in flanged mounting frame

PAGE 272

Security Grille Face Plates Only and Accessories

Security grilles have a large variety of face plates and accessories including angles, anchors, security bars and dampers.

- XG-SGLFO – Lattice face only
- XG-SGRPO – Perforated face only
- XG-SGRP-SRO – Suicide Deterrent
- XG-OBDD – Opposed blade damper
- XG-SBR – Security Bars
- XG-SAB – Steel Anchor Bars
- XG-BSA – Bolted Steel Angles
- XG-LSA – Loose Steel Angles
- XG-WSA – Welded Steel Angles
- XG-WAF – Welded Angle Frame
- XG-DS – Debris Screen

PAGE 282

MODEL XG-SGSP

Maximum Security Supply Grilles – XG-SGSP Square Holes/Mesh Face XG-SGSP – Steel

Air outlets shall be model XG-SGSP manufactured by GREENHECK. Units shall be maximum security supply grilles of steel construction. Units shall have a face plate constructed of 3/16" steel with 2" square holes and 1" fret bars. A 10 gauge woven steel mesh screen shall be inserted directly behind the face panel sandwiched by a 1/4" steel backup plate. This assembly shall be backed by a stitch welded 3/16" thick steel sleeve. Both face and back-up plate shall be stitch welded to the sleeve. Units shall include a 1" border.

The units shall be the size and quantity as outlined in the plans and specifications. Optional opposed blade damper shall be constructed of steel (model XG-OBDD).

Rear operation of the damper is recommended.

Performance Specification

The manufacturer shall provide published performance data. Data shall be tested in accordance to ANSI/ASHRAE Standard 70-2006.

Paint Specification

Process shall be anodic electro-deposition using an anodic acrylic paint. Units shall undergo pre-treatment including a pressurized spray stage using an alkaline cleaner and a de-ionized water rinse.

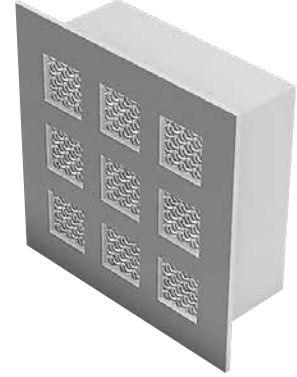

MODEL XG-SGSP

Maximum Steel Security Grille

Models: **XG-SGSP** Maximum Security Grille - Square Holes - Mesh Screen Back

Model: XG-SGSP (Security Grille with Square Holes - Mesh Screen Holes)

Face View XG-SGSP

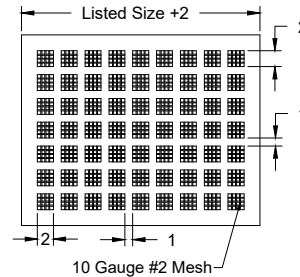
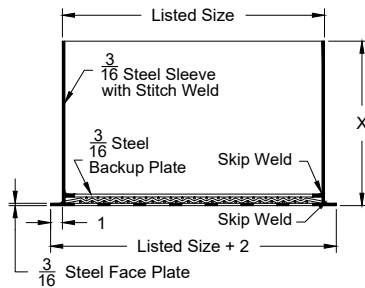

Options

XG-OBDA or XG-OBDA

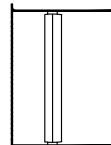

Steel Opposed Blade Damper Rear Operated

XG-SAB

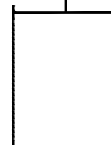

Steel Anchor Bars 1/2" Diameter 3" Long for Concrete Block or Brick Wall.

XG-SBR

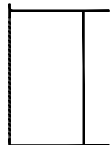

Steel Security Bars 1/2" Diameter Bar on Maximum 6" Centers Welded to Sleeve Vertical & Horizontal

XG-LSA (showed XG-LSA-4)



Loose Steel Angle
XG-LSA-2S - 2 Angles Short Dimension
XG-LSA-2L - 2 Angles Long Dimension
XG-LSA-4 - 4 Angles, L1" x 1" x 3/16" Shipped loose for field welding.

BSA

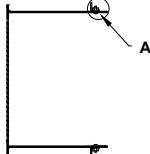

Bolted Steel Angles
XG-BSA-2S - 2 Angles Short Dimension
XG-BSA-2L - 2 Angles Long Dimension
XG-BSA-4 - 4 Angles, L1" x 1" x 3/16" Angle mounting holes punched 1" from each end of the angle for field installation. Customer to use the angle mounting holes to mark up and drill sleeves as necessary. Hardware supplied by others. (nuts & bolts).

WSA

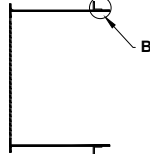

Welded Steel Angles
XG-WSA-2S - 2 Angles Short Dimension
XG-WSA-2L - 2 Angles Long Dimension
XG-WSA-4 - 4 Angles, L1" x 1" x 3/16" Shipped Welded To Sleeve

WAF

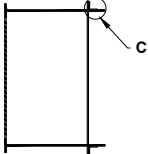

4 Angles, L1" x 1" x 3/16" Welded Steel Angle Flange (Shipped Loose)



Detail A



Detail B



Detail C

XG-SGSP MODEL NUMBER SPECIFICATIONS
MAXIMUM SECURITY – 3/16" STEEL PERFORATED FACE WITH 2" SQUARE HOLES, 10 GAUGE WOVEN STEEL MESH SCREEN AND 1/4" STEEL BACKUP PLATE

Model	Neck										Sleeve	Available Finishes	
XG-SGSP	6	9	12	15	18	21	24	27	30	Steel - Standard			
XG-SGSP - SS	6	X	X	X	X	X	X	X	X	X	4 - 16	01	White
	9		X	X	X	X	X	X	X	X		Steel - Optional	
	12			X	X	X	X	X	X	X		02	Satin Silver
	15				X	X	X	X	X	X		03	Black
	18					X	X	X	X	X		28	Custom Color
	21						X	X	X	X		Stainless Steel - Standard	
	24							X	X	X		23	Satin Polish
	27								X	X		Stainless Steel - Optional	
	30									X		01	White Painted
												02	Satin Silver Painted
											03	Black Painted	
											28	Custom Color	

Available Accessories - Steel		Available Accessories - Stainless Steel	
XG-OBD	Steel Opposed Blade Damper	XG-OBD-SS	Stainless Steel Opposed Blade Damper
XG-SAB	Steel Anchor Bars	XG-SAB-SS	Stainless Steel Anchor Bars
XG-SBR	Steel Security Bars	XG-SBR-SS	Stainless Steel Security Bars
XG-LSA	Loose Steel Angle	XG-LSA-SS	Loose Stainless Steel Angle
XG-BSA	Bolted Steel Angle	XG-BSA-SS	Bolted Stainless Steel Angle
XG-WSA	Welded Steel Angle	XG-WSA-SS	Welded Stainless Steel Angle
XG-WAF	Welded Steel Angle Frame	XG-WAF-SS	Welded Stainless Steel Angle Frame
		XG-316-SS	316 Stainless Steel

**SERIES XG-SGSP PERFORMANCE DATA
MODEL XG-SGSP**

Size (in)	NK Vel	100	150	200	250	300	350	400	450	500	550	600
Neck Area ft ²	Ps	.005	.010	.018	.029	.042	.058	.075	.094	.117	.140	.166
06x06 .250	CFM	25	38	50	63	75	88	100	113	125	138	150
	Throws	2-7	3-10	5-12	6-13	7-15	9-16	10-17	10-18	11-19	12-20	12-21
	NC	-	-	-	14	20	24	28	32	35	38	40
08x08 .444	CFM	44	67	89	111	133	155	178	200	222	244	266
	Throws	2-10	5-14	7-16	8-18	10-20	12-21	13-23	14-24	15-25	15-27	16-28
	NC	-	-	-	17	22	27	31	34	37	40	43
09x09 .563	CFM	56	84	113	141	169	197	225	253	282	310	338
	Throws	2-11	5-16	7-18	9-20	11-22	13-24	15-25	16-27	16-28	17-30	18-31
	NC	-	-	11	18	23	28	32	35	38	41	44
12x06 .500	CFM	50	75	100	125	150	175	200	225	250	275	300
	Throws	2-11	5-15	7-17	9-19	11-21	12-22	14-24	15-25	15-27	16-28	17-29
	NC	-	-	-	17	23	27	31	35	38	41	43
12x12 1.000	CFM	100	150	200	250	300	350	400	450	500	550	600
	Throws	3-15	7-21	10-24	12-27	15-29	17-32	10-24	21-36	22-38	23-40	24-42
	NC	-	-	13	20	26	30	34	38	41	44	46
15x12 1.250	CFM	125	188	250	313	375	438	500	563	625	688	750
	Throws	3-17	8-23	11-27	14-30	17-33	20-35	22-38	23-42	24-42	26-45	27-46
	NC	-	-	14	21	27	31	35	39	42	45	47
15x15 1.563	CFM	156	234	313	391	469	547	625	703	782	860	938
	Throws	4-19	9-26	12-30	16-34	19-37	22-40	25-42	26-45	27-47	29-50	30-52
	NC	-	-	15	22	28	32	36	40	43	46	48
18x12 1.500	CFM	150	225	300	375	450	525	600	675	750	825	900
	Throws	4-18	8-25	12-29	15-33	18-36	21-39	24-42	25-44	27-46	28-49	29-51
	NC	-	-	15	22	27	32	36	39	43	45	48
18x18 2.250	CFM	225	338	450	563	675	788	900	1013	1125	1238	1350
	Throws	5-22	10-31	15-36	19-40	22-44	26-48	29-51	31-54	33-57	34-60	36-62
	NC	-	11	17	24	29	34	38	41	44	47	50
21x21 3.063	CFM	306	459	613	766	919	1072	1225	1378	1532	1685	1838
	Throws	5-26	12-36	17-42	22-47	26-51	31-56	34-59	36-63	38-66	40-70	42-73
	NC	-	12	18	25	30	35	39	43	46	49	51
24x12 2.000	CFM	200	300	400	500	600	700	800	900	1000	1100	1200
	Throws	4-21	10-29	14-34	18-36	21-42	25-45	28-48	29-51	31-54	32-56	34-59
	NC	-	-	16	23	29	33	37	41	44	47	49

SERIES XG-SGSP PERFORMANCE DATA
MODEL XG-SGSP

Size (in)	NK Vel	100	150	200	250	300	350	400	450	500	550	600
Neck Area ft ²	Ps	.005	.010	.018	.029	.042	.058	.075	.094	.117	.140	.166
24x24 4.000	CFM	400	600	800	1000	1200	1400	1600	1800	2000	2200	2400
	Throws	6-30	14-42	20-48	25-54	30-59	35-63	39-68	42-72	44-76	46-80	48-83
	NC	-	11	20	26	32	36	40	44	47	50	52
27x27 5.063	CFM	506	759	1013	1266	1519	1772	2025	2278	2532	2785	3038
	Throws	7-34	15-47	22-54	28-60	34-66	39-71	44-76	47-81	49-85	52-90	54-94
	NC	-	12	21	27	33	37	41	45	48	51	53
30x24 5.000	CFM	500	750	1000	1250	1500	1750	2000	2250	2500	2750	3000
	Throws	7-33	15-46	22-54	28-60	33-66	39-71	44-76	46-80	49-85	51-89	54-93
	NC	-	12	20	27	33	37	41	45	48	51	53
30x30 6.250	CFM	625	938	1250	1563	1875	2188	2500	2813	3125	3438	3750
	Throws	4-31	10-47	18-60	26-67	31-73	36-79	42-85	47-90	52-95	57-100	60-104
	NC	-	-	12	19	24	29	33	36	40	42	45

PERFORMANCE NOTES FOR SERIES XG-SGSP

All data is tested in accordance with ANSI/ASHRAE 70-2006.

DEFINITION OF UNITS

CFM Cubic Feet per Minute (air)

Nk Vel Neck Velocity is the airstream velocity in the duct just before it reaches the supply outlet; measured in feet per minute

Ps Static pressure = $P_t - P_v$ (inches of water column)

Throw Throw distance in feet are for terminal velocities of 150 and 50 fpm respectively

NC Noise criterion, sound pressure level NC ratings are based on sound power level (Lw) re: 10^{-12} watts minus a 10dB room attenuation in all octave bands

MODEL XG-SGRP

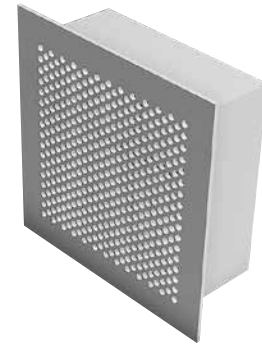

Maximum Security Grilles –

XG-SGRP Security Grille with Perforated Face

XG-SGRP - Steel

XG-SGRP-SS - Stainless Steel

XG-SGRP-SR - Suicide Resistant

XG-SGRP-SS-SR - Stainless Steel, Suicide Resistant

XG-SGRP-AL - Aluminum, Minimum Security

XG-SGRP-AL-SR - Aluminum, Suicide Resistant, Minimum Security

Air outlets (or inlets) shall be model XG-SGRP manufactured by GREENHECK. Units shall be maximum security supply grilles of steel construction. Units shall have a perforated face plate backed by a stitch welded 3/16" steel sleeve. Face plate shall be constructed of 3/16" steel with 5/16" perforations on 7/16" staggered centers and shall be stitch welded to the sleeve. Units shall include a 1" border.

The units shall be the size and quantity as outlined in the plans and specifications. Optional opposed blade damper shall be constructed of steel (model XG-OBD).

Rear operation of the damper is recommended.

Performance Specification

The manufacturer shall provide published performance data. Data shall be tested in accordance to ANSI/ASHRAE Standard 70-2006.

Paint Specification

Process shall be anodic electro-deposition using an anodic acrylic paint. Units shall undergo pre-treatment including a pressurized spray stage using an alkaline cleaner and a de-ionized water rinse.

MODEL XG-SGRP

Security Grilles / Registers Steel

Models: **XG-SGRP** Security Grille - With Perforated Face

Model: XG-SGRP (Security Grille with Perforated Face)

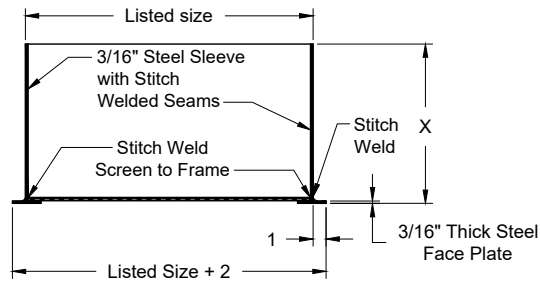

Face View

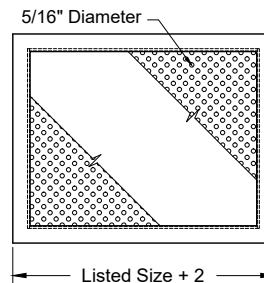

X = Sleeve Length (Has to be specified)

Options

XG-OBD

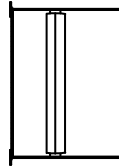

Steel Opposed
Blade Damper
Rear Operated

XG-SAB



Steel Anchor Bars
1/2" Diameter 3" Long
for Concrete Block
or Brick Wall.

XG-SBR

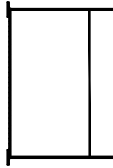

Steel Security Bars
1/2" Diameter Bar on
Maximum 6" Centers
Welded to Sleeve
Vertical & Horizontal

XG-LSA (showed XG-LSA-4)



Loose Steel Angle
XG-LSA-2S - 2 Angles Short Dimension
XG-LSA-2L - 2 Angles Long Dimension
XG-LSA-4 - 4 Angles,
XG-L1" x 1" x 3/16" Shipped loose for field welding

XG-BSA

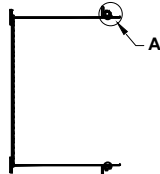

Mounting holes located 1" from edge
Holes in sleeve drilled where needed

Hardware provided by others
(nuts/bolts)

Bolted Steel Angles
XG-BSA-2S - 2 Angles Short Dimension
XG-BSA-2L - 2 Angles Long Dimension
XG-BSA-4 - 4 Angles, L1" x 1" x 3/16"
Shipped Bolted to Sleeve

XG-WSA

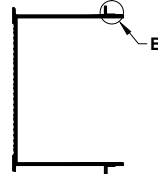

Welded Steel Angles
XG-WSA-2S - 2 Angles Short Dimension
XG-WSA-2L - 2 Angles Long Dimension
XG-WSA-4 - 4 Angles, L1" x 1" x 3/16"
Shipped Welded To Sleeve

XG-WAF

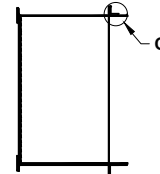

L1" x 1" x 3/16"
Welded Steel Angle Flange
(Shipped Loose)



Detail A



Detail B



Detail C

XG-SGRP MODEL NUMBER SPECIFICATION
MAXIMUM SECURITY – 5/16" PERFORATED FACE
WITH 7/16" STAGGERED CENTERS

Model	Neck																Sleeve	
XG-SGRP	6	8	9	10	12	14	15	16	18	20	21	22	24	26	28	30	4 - 16	
XG-SGRP-SS	X	X	X	X	X	X	X	X	X	X	X	X	X	X	X	X		
		X	X	X	X	X	X	X	X	X	X	X	X	X	X	X		
			X	X	X	X	X	X	X	X	X	X	X	X	X	X		
				X	X	X	X	X	X	X	X	X	X	X	X	X		
					X	X	X	X	X	X	X	X	X	X	X	X		
						X	X	X	X	X	X	X	X	X	X	X		
							X	X	X	X	X	X	X	X	X	X		
								X	X	X	X	X	X	X	X	X		
									X	X	X	X	X	X	X	X		
										X	X	X	X	X	X	X		
											X	X	X	X	X	X		
												X	X	X	X	X		
													X	X	X	X		
														X	X	X		
															X	X		
																X		

Available Finishes		Available Accessories - Steel		Available Accessories - Stainless Steel	
Steel - Standard		XG-OBD	Steel Opposed Blade Damper	XG-OBD-SS	Stainless Steel Opposed Blade Damper
01	White	XG-SAB	Steel Anchor Bars	XG-SAB-SS	Stainless Steel Anchor Bars
Steel - Optional		XG-SBR	Steel Security Bars	XG-SBR-SS	Stainless Steel Security Bars
02	Satin Silver	XG-LSA	Loose Steel Angle	XG-LSA-SS	Loose Stainless Steel Angle
03	Black	XG-BSA	Bolted Steel Angle	XG-BSA-SS	Bolted Stainless Steel Angle
28	Custom Color	XG-WSA	Welded Steel Angle	XG-WSA-SS	Welded Stainless Steel Angle
Stainless Steel - Standard		XG-WAF	Welded Steel Angle Frame	XG-WAF-SS	Welded Stainless Steel Angle Frame
23	Satin Polish	XG-SH	Optional Screw Holes In Face	316-SSXG-	316 Stainless Steel
Stainless Steel - Optional					
01	White Painted				
02	Satin Silver Painted				
03	Black Painted				
28	Custom Color				

SERIES XG-SGRP PERFORMANCE DATA
MODEL XG-SGRP

Size (in)	NK Vel	100	150	200	250	300	350	400	450	500	600	700
Neck Area ft ²	Ps	.002	.004	.008	.012	.018	.024	.032	.040	.049	.071	.096
06x06 .250	CFM	25	38	50	63	75	88	100	113	125	150	175
	Throws	1-5	2-7	3-10	4-12	5-13	6-15	6-16	7-17	8-17	10-19	11-21
	NC	-	-	-	-	11	15	19	23	26	31	36
08x06 .333	CFM	34	50	67	84	100	117	134	150	167	200	234
	Throws	1-5	2-8	4-11	5-14	6-16	6-17	7-18	8-19	9-20	11-22	13-24
	NC	-	-	-	-	12	16	20	24	27	33	37
08x08 .444	CFM	45	67	89	111	134	156	178	200	222	267	311
	Throws	1-6	3-9	4-13	5-16	6-18	7-19	8-21	10-22	11-23	13-25	15-27
	NC	-	-	-	-	13	18	22	25	26	34	38
09x06 .375	CFM	38	57	75	94	113	132	150	169	188	225	263
	Throws	1-6	3-9	4-12	5-15	6-17	7-18	8-19	9-20	10-21	12-23	14-25
	NC	-	-	-	-	12	17	21	25	28	33	38
09x09 .563	CFM	57	85	113	141	169	198	226	254	282	338	395
	Throws	1-7	3-11	5-14	6-18	7-20	8-22	10-23	11-25	12-26	14-29	17-31
	NC	-	-	-	-	14	19	23	26	29	35	39
10x06 .417	CFM	42	63	84	105	126	146	167	188	209	251	292
	Throws	1-6	3-9	4-12	5-15	6-17	7-19	8-20	9-21	10-22	12-25	14-27
	NC	-	-	-	-	13	18	21	25	28	34	38
10x08 .556	CFM	56	84	112	139	167	195	223	251	278	334	390
	Throws	1-7	3-11	5-14	6-18	7-20	8-22	9-23	11-25	12-26	14-28	17-31
	NC	-	-	-	-	14	19	23	26	29	35	39
10x10 .694	CFM	70	105	139	174	209	243	278	313	347	417	486
	Throws	1-8	3-12	5-16	7-20	8-22	9-24	11-26	12-27	13-29	16-32	19-34
	NC	-	-	-	-	15	20	24	27	30	36	40
12x06 .500	CFM	50	75	100	125	150	175	200	225	250	300	350
	Throws	1-7	3-10	5-14	6-17	7-19	8-21	9-22	10-21	11-25	14-27	16-29
	NC	-	-	-	-	14	18	22	26	29	34	39
12x08 .667	CFM	67	101	134	167	201	234	267	301	334	401	467
	Throws	1-8	3-12	5-16	7-20	8-22	9-24	10-25	12-27	13-28	16-31	18-34
	NC	-	-	-	-	15	20	23	27	30	36	40
12x10 .833	CFM	84	125	167	209	250	292	334	375	417	500	584
	Throws	2-9	4-13	6-17	7-12	9-25	10-27	12-28	13-30	15-32	17-35	20-38
	NC	-	-	-	-	16	20	24	28	31	37	41
12x12 1.000	CFM	100	150	200	250	300	350	400	450	500	600	700
	Throws	2-10	4-14	6-19	8-24	10-27	11-29	13-31	14-33	16-35	19-38	22-41
	NC	-	-	-	11	17	21	25	29	32	37	42

SERIES XG-SGRP PERFORMANCE DATA
MODEL XG-SGRP

Size (in)	NK Vel	100	150	200	250	300	350	400	450	500	600	700
Neck Area ft ²	Ps	.002	.004	.008	.012	.018	.024	.032	.040	.049	.071	.096
14x08 .778	CFM	78	117	156	195	234	273	312	351	389	467	545
	Throws	2-8	4-13	6-17	7-21	8-24	10-26	11-27	13-29	14-31	17-34	20-36
	NC	-	-	-	-	16	20	24	28	31	36	41
14x14 1.361	CFM	137	205	273	341	409	477	545	613	681	817	953
	Throws	2-11	5-17	7-22	9-28	11-31	13-34	15-36	17-39	19-41	22-44	27-49
	NC	-	-	-	12	18	23	27	30	33	39	44
15x15 1.563	CFM	157	235	313	391	469	548	626	704	782	938	1095
	Throws	2-12	5-18	8-24	10-30	12-34	14-36	16-39	18-41	20-44	24-48	28-51
	NC	-	-	-	13	19	23	27	31	34	39	44
16x10 1.111	CFM	112	167	223	278	334	389	445	500	556	667	778
	Throws	2-10	4-15	7-20	8-25	10-28	12-31	13-33	15-35	17-37	20-40	23-43
	NC	-	-	-	12	17	22	26	29	32	38	42
16x12 1.333	CFM	134	200	267	334	400	467	534	600	667	800	934
	Throws	2-11	5-17	7-22	9-28	11-31	13-34	15-36	17-38	18-40	22-44	26-48
	NC	-	-	-	12	18	22	26	30	33	39	43
16x16 1.778	CFM	178	267	356	445	534	623	712	801	889	1067	1245
	Throws	2-13	5-19	8-25	11-32	13-36	15-39	17-41	19-44	21-46	25-51	30-55
	NC	-	-	-	14	19	24	28	31	34	40	44

PERFORMANCE NOTES FOR SERIES XG-SGRP

All data is tested in accordance with ANSI/ASHRAE 70-2006.

DEFINITION OF UNITS

CFM Cubic Feet per Minute (air)

Nk Vel Neck Velocity is the airstream velocity in the duct just before it reaches the supply outlet; measured in Feet per Minute

NC Noise criterion, sound pressure level NC ratings are based on sound power level (Lw) re: 10⁻¹² watts minus a 10dB room attenuation in all octave bands

Throw Throw distance in feet are for terminal velocities of 50 and 100fpm respectively

Ps Static pressure = Pt-Pv (inches of water column)

MODEL XG-SGRP- SR

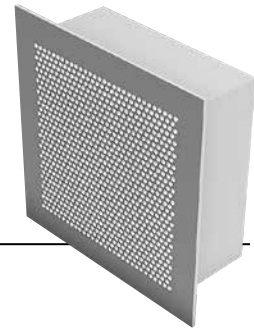

Maximum Steel Security Grille

Models: **XG-SGRP-SR** Maximum Steel Suicide Deterrent Security Grille Perforated Face

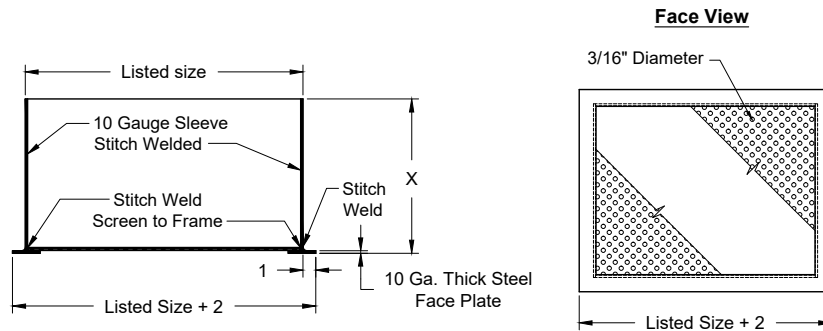

X = Sleeve Length (Has to be specified)

Options

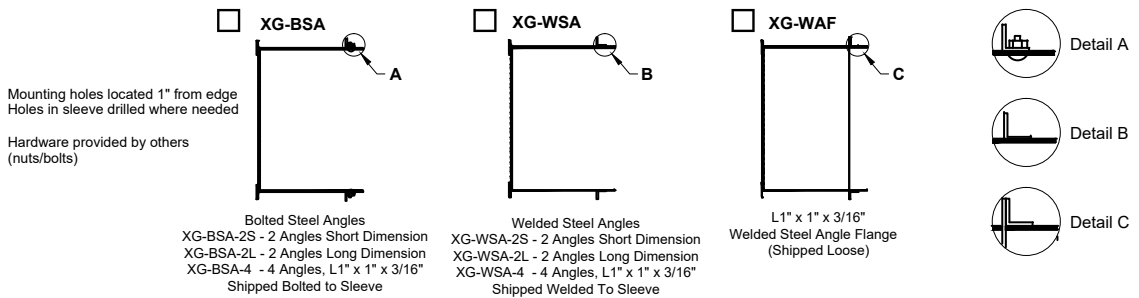
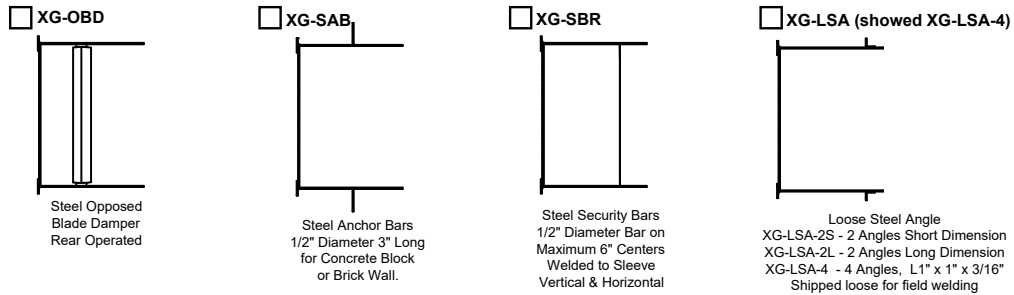

**XG-SGRP-SR MODEL NUMBER SPECIFICATION
 MAXIMUM SECURITY – 3/16" PERFORATED FACE
 WITH 9/32" STAGGERED CENTERS**

Model	Neck																Sleeve	
	6	8	9	10	12	14	15	16	18	20	21	22	24	26	28	30		
XG-SGRP-SR																		
XG-SGRP-SR-SS	6	X	X	X	X	X	X	X	X	X	X	X	X	X	X	X	X	4 - 16
	8		X	X	X	X	X	X	X	X	X	X	X	X	X	X		
	9			X	X	X	X	X	X	X	X	X	X	X	X	X		
	10				X	X	X	X	X	X	X	X	X	X	X	X		
	12					X	X	X	X	X	X	X	X	X	X	X		
	14						X	X	X	X	X	X	X	X	X	X		
	15							X	X	X	X	X	X	X	X	X		
	16								X	X	X	X	X	X	X	X		
	18									X	X	X	X	X	X	X		
	20										X	X	X	X	X	X		
	21											X	X	X	X	X		
	22												X	X	X	X		
	24													X	X	X		
	26														X	X		
	28															X	X	
	30																X	

Finishes		Accessories - Steel		Accessories - Stainless Steel	
Steel - Standard		XG-OBD	Steel Opposed Blade Damper	XG-OBD-SS	Stainless Steel Opposed Blade Damper
01	White	XG-SAB	Steel Anchor Bars	XG-SAB-SS	Stainless Steel Anchor Bars
Steel - Optional		XG-SBR	Steel Security Bars	XG-SBR-SS	Stainless Steel Security Bars
02	Satin Silver	XG-LSA	Loose Steel Angle	XG-LSA-SS	Loose Stainless Steel Angle
03	Black	XG-BSA	Bolted Steel Angle	XG-BSA-SS	Bolted Stainless Steel Angle
28	Custom Color	XG-WSA	Welded Steel Angle	XG-WSA-SS	Welded Stainless Steel Angle
Stainless Steel - Standard		XG-WAF	Welded Steel Angle Frame	XG-WAF-SS	Welded Stainless Steel Angle Frame
23	Satin Polish			XG-316-SS	316 Stainless Steel
Stainless Steel - Optional					
01	White Painted				
02	Satin Silver Painted				
03	Black Painted				
28	Custom Color				

SERIES XG-SGRP-SR PERFORMANCE DATA
MODEL XG-SGRP-SR

Size (in)	NK Vel	100	150	200	250	300	350	400	450	500	600	700
Neck Area ft ²	Ps	.002	.005	.009	.014	.020	.026	.035	.044	.054	.078	.106
06x06 .250	CFM	25	38	50	63	75	88	100	113	125	150	175
	Throws	1-5	2-7	3-10	4-12	5-13	6-15	6-16	7-17	8-17	10-19	11-21
	NC	-	-	-	-	14	18	22	26	29	34	39
08x06 .333	CFM	34	50	67	84	100	117	134	150	167	200	234
	Throws	1-5	2-8	4-11	5-14	6-16	6-17	7-18	8-19	9-20	11-22	13-24
	NC	-	-	-	-	15	19	23	27	30	36	40
08x08 .444	CFM	45	67	89	111	134	156	178	200	222	267	311
	Throws	1-6	3-9	4-13	5-16	6-18	7-19	8-21	10-22	11-23	13-25	15-27
	NC	-	-	-	11	16	21	25	28	31	37	41
09x06 .375	CFM	38	57	75	94	113	132	150	169	188	225	263
	Throws	1-6	3-9	4-12	5-15	6-17	7-18	8-19	9-20	10-21	12-23	14-25
	NC	-	-	-	-	15	20	24	28	31	36	41
09x09 .563	CFM	57	85	113	141	169	198	226	254	282	338	395
	Throws	1-7	3-11	5-14	6-18	7-20	8-22	10-23	11-25	12-26	14-29	17-31
	NC	-	-	-	12	17	22	26	29	32	38	42
10x06 .417	CFM	42	63	84	105	126	146	167	188	209	251	292
	Throws	1-6	3-9	4-12	5-15	6-17	7-19	8-20	9-21	10-22	12-25	14-27
	NC	-	-	-	-	16	21	24	28	31	37	41
10x08 .556	CFM	56	84	112	139	167	195	223	251	278	334	390
	Throws	1-7	3-11	5-14	6-18	7-20	8-22	9-23	11-25	12-26	14-28	17-31
	NC	-	-	-	12	17	22	26	29	32	38	42
10x10 .694	CFM	70	105	139	174	209	243	278	313	347	417	486
	Throws	1-8	3-12	5-16	7-20	8-22	9-24	11-26	12-27	13-29	16-32	19-34
	NC	-	-	-	13	18	23	27	30	33	39	43
12x06 .500	CFM	50	75	100	125	150	175	200	225	250	300	350
	Throws	1-7	3-10	5-14	6-17	7-19	8-21	9-22	10-21	11-25	14-27	16-29
	NC	-	-	-	11	17	21	25	29	32	37	42
12x08 .667	CFM	67	101	134	167	201	234	267	301	334	401	467
	Throws	1-8	3-12	5-16	7-20	8-22	9-24	10-25	12-27	13-28	16-31	18-34
	NC	-	-	-	12	18	23	26	30	33	39	43
12x10 .833	CFM	84	125	167	209	250	292	334	375	417	500	584
	Throws	2-9	4-13	6-17	7-12	9-25	10-27	12-28	13-30	15-32	17-35	20-38
	NC	-	-	-	13	19	23	27	31	34	40	44

SERIES XG-SGRP-SR PERFORMANCE DATA
MODEL XG-SGRP-SR

Size (in)	NK Vel	100	150	200	250	300	350	400	450	500	600	700
Neck Area ft ²	Ps	.002	.005	.009	.014	.020	.026	.035	.044	.054	.078	.106
12x12 1.000	CFM	100	150	200	250	300	350	400	450	500	600	700
	Throws	2-10	4-14	6-19	8-24	10-27	11-29	13-31	14-33	16-35	19-38	22-41
	NC	-	-	-	14	20	24	28	32	35	40	45
14x08 .778	CFM	78	117	156	195	234	273	312	351	389	467	545
	Throws	2-8	4-13	6-17	7-21	8-24	10-26	11-27	13-29	14-31	17-34	20-36
	NC	-	-	-	13	19	23	27	31	34	39	44
14x14 1.361	CFM	137	205	273	341	409	477	545	613	681	817	953
	Throws	2-11	5-17	7-22	9-28	11-31	13-34	15-36	17-39	19-41	22-44	27-49
	NC	-	-	-	15	21	26	30	33	36	42	46
15x15 1.563	CFM	157	235	313	391	469	548	626	704	782	938	1095
	Throws	2-12	5-18	8-24	10-30	12-34	14-36	16-39	18-41	20-44	24-48	28-51
	NC	-	-	-	16	22	26	30	34	37	42	47
16x10 1.111	CFM	112	167	223	278	334	389	445	500	556	667	778
	Throws	2-10	4-15	7-20	8-25	10-28	12-31	13-33	15-35	17-37	20-40	23-43
	NC	-	-	-	15	20	25	29	32	35	41	45
16x12 1.333	CFM	134	200	267	334	400	467	534	600	667	800	934
	Throws	2-11	5-17	7-22	9-28	11-31	13-34	15-36	17-38	18-40	22-44	26-48
	NC	-	-	-	15	21	25	29	33	36	42	46
16x16 1.778	CFM	178	267	356	445	534	623	712	801	889	1067	1245
	Throws	2-13	5-19	8-25	11-32	13-36	15-39	17-41	19-44	21-46	25-51	30-55
	NC	-	-	-	17	22	27	31	34	37	43	47

PERFORMANCE NOTES FOR SERIES XG-SGRP-SR

All data is tested in accordance with ANSI/ASHRAE 70-2006.

DEFINITION OF UNITS

CFM Cubic Feet per Minute (air)

Nk Vel Neck Velocity is the airstream velocity in the duct just before it reaches the supply outlet; measured in Feet per Minute

NC Noise criterion, sound pressure level NC ratings are based on sound power level (Lw) re: 10⁻¹² watts minus a 10dB room attenuation in all octave bands

Throw Throw distance in feet are for terminal velocities of 50 and 100fpm respectively

Ps Static pressure = Pt-Pv (inches of water column)

SERIES XG-SGRP-SR PERFORMANCE DATA
MODEL XG-SGRP-SR

Size (in)	NK Vel	100	150	200	250	300	350	400	450	500	600	700
Neck Area ft ²	Ps	.002	.005	.009	.014	.020	.026	.035	.044	.054	.078	.106
18x12 1.500	CFM	150	225	300	375	450	525	600	675	750	900	1050
	Throws	2-12	5-18	8-23	10-29	12-33	14-36	16-38	18-40	19-43	23-47	27-50
	NC	-	-	-	16	21	26	30	33	37	42	47
18x18 2.250	CFM	225	338	450	563	675	788	900	1013	1125	1350	1575
	Throws	3-14	6-21	10-29	12-36	14-40	17-44	19-47	21-50	24-52	29-57	33-62
	NC	-	-	11	18	23	28	32	35	38	44	48
20x20 2.778	CFM	278	417	556	695	834	973	1112	1251	1389	1667	1945
	Throws	3-16	7-24	11-32	13-40	16-25	19-49	21-52	24-55	27-58	32-64	37-69
	NC	-	-	12	19	24	29	33	36	39	45	49
21x21 3.063	CFM	307	460	613	766	919	1073	1226	1379	1532	1838	2145
	Throws	3-17	7-25	11-33	14-42	17-47	19-51	22-54	25-58	28-61	33-67	39-72
	NC	-	-	12	19	24	29	33	37	40	45	50
22x22 3.361	CFM	337	505	673	841	1009	1177	1345	1513	1681	2017	2353
	Throws	3-17	7-26	12-35	15-44	18-49	20-53	23-57	26-61	29-64	35-70	41-75
	NC	-	-	13	19	25	29	33	37	40	46	50
24x06 1.000	CFM	100	150	200	250	300	350	400	450	500	600	700
	Throws	2-10	4-14	6-19	8-24	10-27	11-29	13-31	14-33	16-35	19-38	22-41
	NC	-	-	-	14	20	24	28	32	35	40	45
24x08 1.333	CFM	134	200	267	334	400	467	534	600	667	800	934
	Throws	2-11	5-17	7-22	9-28	11-31	13-34	15-36	17-38	18-40	22-44	26-48
	NC	-	-	-	15	21	25	29	33	36	42	46
24x12 2.000	CFM	200	300	400	500	600	700	800	900	1000	1200	1400
	Throws	3-14	6-20	9-27	11-34	14-38	16-41	18-44	20-47	23-49	27-54	32-58
	NC	-	-	-	17	23	27	31	35	38	43	48
24x18 3.000	CFM	300	450	600	750	900	1050	1200	1350	1500	1800	2100
	Throws	3-17	7-25	11-33	14-41	17-47	19-50	22-54	25-57	28-61	33-66	39-71
	NC	-	-	12	19	24	29	33	36	40	45	50
24x24 4.000	CFM	400	600	800	1000	1200	1400	1600	1800	2000	2400	2800
	Throws	4-19	8-29	13-38	16-48	19-54	22-58	25-62	29-66	32-70	38-76	45-82
	NC	-	-	14	20	26	30	34	38	41	46	51
26x26 4.694	CFM	470	705	939	1174	1409	1643	1878	2113	2347	2817	3286
	Throws	4-21	9-31	14-41	17-52	21-58	24-63	28-67	31-71	34-75	41-83	48-89
	NC	-	-	14	21	26	31	35	38	42	47	52

SERIES XG-SGRP-SR PERFORMANCE DATA
MODEL XG-SGRP-SR

Size (in)	NK Vel	100	150	200	250	300	350	400	450	500	600	700
Neck Area ft ²	Ps	.002	.005	.009	.014	.020	.026	.035	.044	.054	.078	.106
30x12 2.500	CFM	250	375	500	625	750	875	1000	1125	1250	1500	1750
	Throws	3-15	6-23	10-30	13-38	15-43	18-46	20-49	23-52	25-55	30-60	35-65
	NC	-	-	11	18	24	28	32	36	39	44	49
30x24 5.000	CFM	500	750	1000	1250	1500	1750	2000	2250	2500	3000	3500
	Throws	4-21	9-32	14-43	18-53	21-60	25-65	28-70	32-74	36-78	43-85	50-92
	NC	-	-	14	21	27	31	35	39	42	47	52
30x30 6.250	CFM	625	938	1250	1563	1875	2188	2500	2813	3125	3750	4375
	Throws	4-24	10-36	16-48	20-60	24-67	28-73	32-78	36-83	40-87	48-95	56-103
	NC	-	-	15	22	28	32	36	40	43	48	53

PERFORMANCE NOTES FOR SERIES XG-SGRP-SR

All data is tested in accordance with ANSI/ASHRAE 70-2006.

DEFINITION OF UNITS

CFM Cubic Feet per Minute (air)

Nk Vel Neck Velocity is the airstream velocity in the duct just before it reaches the supply outlet; measured in Feet per Minute

NC Noise criterion, sound pressure level NC ratings are based on sound power level (Lw) re: 10⁻¹² watts minus a 10dB room attenuation in all octave bands

Throw Throw distance in feet are for terminal velocities of 50 and 100fpm respectively

Ps Static pressure = Pt-Pv (inches of water column)

MODEL XG-SGRH

Air outlets shall be model XG-SGRH manufactured by GREENHECK. Units shall be minimum security supply grilles of steel construction. Units shall have 14 gauge horizontal fixed louvers set at 0° (or 40°) on 1/2" centers. Louvers shall be reinforced and welded to a steel sleeve. Units shall include a 14 gauge steel face plate and a 10 gauge by #2 wire mesh screen located behind the louvers and secured by 1/8" welded angle. Units shall include a 1 1/2" border.

The units shall be the size and quantity as outline in the plans and specifications.

Optional opposed blade damper shall be constructed of steel (model XG-OBD) or aluminum (model XG-OBDA). Damper must be operable from the face of the diffuser.

Performance Specification

The manufacturer shall provide published performance data. Data shall be tested in accordance to ANSI/ASHRAE Standard 70- 2006

Model: XG-SGRH (Security Grille - Fixed Louver Face)

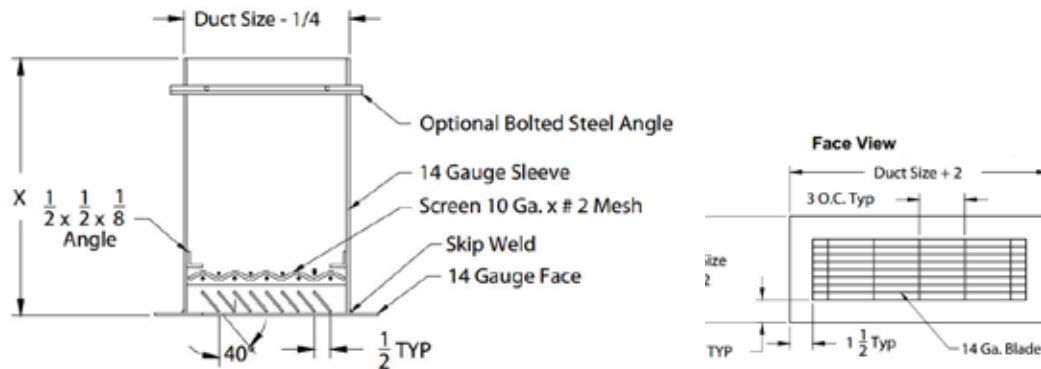

X = Sleeve Length (Has to be specified)

Options

XG-OBD

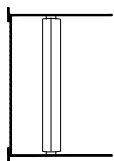

Steel Opposed Blade Damper Rear Operated

XG-SAB

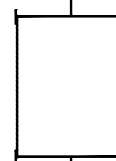

Steel Anchor Bars 1/2" Diameter 3" Long for Concrete Block or Brick Wall.

XG-SBR

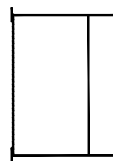

Steel Security Bars 1/2" Diameter Bar on Maximum 6" Centers Welded to Sleeve Vertical & Horizontal

XG-LSA (showed XG-LSA-4)



Loose Steel Angle
 LSA-2S - 2 Angles Short Dimension
 LSA-2L - 2 Angles Long Dimension
 LSA-4 - 4 Angles, L1" x 1" x 3/16"
 Shipped loose for field welding.

XG-BSA

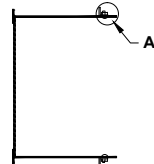

Bolted Steel Angles
 XG-BSA-2S - 2 Angles Short Dimension
 XG-BSA-2L - 2 Angles Long Dimension
 XG*BSA-4 - 4 Angles, L1" x 1" x 3/16"
 Angle mounting holes punched 1" from each end of the angle for field installation Customer to use the angle mounting holes to mark up and drill sleeves as necessary hardware supplied by others. (nuts & bolts)

XG-WSA

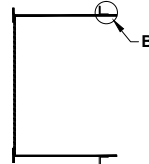

Welded Steel Angles
 XG-WSA-2S - 2 Angles Short Dimension
 XG-WSA-2L - 2 Angles Long Dimension
 XG-WSA-4 - 4 Angles, L1" x 1" x 3/16"
 Shipped Welded To Sleeve

XG-WAF

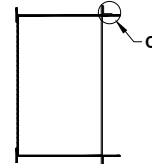

4 Angles, L1" x 1" x 3/16" Welded Steel Angle Flange (Shipped Loose)



Detail A



Detail B



Detail C



**XG-SGRH MODEL NUMBER SPECIFICATION
MEDIUM SECURITY RETURN GRILLE**

Model	Neck												Sleeve
XG-SGRH	6	8	10	12	14	16	18	20	22	24	26		
6	X	X	X	X	X	X	X	X	X	X	X	4 - 16	
8	X	X	X	X	X	X	X	X	X	X	X		
10	X	X	X	X	X	X	X	X	X	X	X		
12	X	X	X	X	X	X	X	X	X	X	X		
14	X	X	X	X	X	X	X	X	X	X	X		
16	X	X	X	X	X	X	X	X	X	X	X		
18	X	X	X	X	X	X	X	X	X	X	X		
20	X	X	X	X	X	X	X	X	X	X	X		
22	X	X	X	X	X	X	X	X	X	X	X		
24	X	X	X	X	X	X	X	X	X	X	X		
26	X	X	X	X	X	X	X	X	X	X	X		
28	X	X	X	X	X	X	X	X	X	X	X		
30	X	X	X	X	X	X	X	X	X	X	X		
32	X	X	X	X	X	X	X	X	X	X	X		
34	X	X	X	X	X	X	X	X	X	X	X		
36	X	X	X	X	X	X	X	X	X	X	X		
38	X	X	X	X	X	X	X	X	X	X	X		
40	X	X	X	X	X	X	X	X	X	X	X		
42	X	X	X	X	X	X	X	X	X	X	X		
44	X	X	X	X	X	X	X	X	X	X	X		
46	X	X	X	X	X	X	X	X	X	X	X		
48	X	X	X	X	X	X	X	X	X	X	X		

Available Finishes		Available Accessories	
Steel - Standard		XG-OBD	Steel Opposed Blade Damper
01	White	XG-SAB	Steel Anchor Bars
Steel - Optional		XG-SBR	Steel Security Bars
02	Satin Silver	XG-LSA	Loose Steel Angle
03	Black	XG-BSA	Bolted Steel Angle
28	Custom Color	XG-WSA	Welded Steel Angle
		XG-SH	Screw Holes In Face

XG-SGRH MODEL NUMBER SPECIFICATION
MEDIUM SECURITY RETURN GRILLE

Model	Neck											Sleeve
XG-SGRH	28	30	32	34	36	38	40	42	44	46	48	
6	X	X	X	X	X	X	X	X	X	X	X	X
8	X	X	X	X	X	X	X	X	X	X	X	X
10	X	X	X	X	X	X	X	X	X	X	X	X
12	X	X	X	X	X	X	X	X	X	X	X	X
14	X	X	X	X	X	X	X	X	X	X	X	X
16	X	X	X	X	X	X	X	X	X	X	X	X
18	X	X	X	X	X	X	X	X	X	X	X	X
20	X	X	X	X	X	X	X	X	X	X	X	X
22	X	X	X	X	X	X	X	X	X	X	X	X
24	X	X	X	X	X	X	X	X	X	X	X	X
26	X	X	X	X	X	X	X	X	X	X	X	X
28	X	X	X	X	X	X	X	X	X	X	X	X
30	X	X	X	X	X	X	X	X	X	X	X	X
32	X	X	X	X	X	X	X	X	X	X	X	X
34	X	X	X	X	X	X	X	X	X	X	X	X
36	X	X	X	X	X	X	X	X	X	X	X	X
38	X	X	X	X	X	X	X	X	X	X	X	X
40	X	X	X	X	X	X	X	X	X	X	X	X
42	X	X	X	X	X	X	X	X	X	X	X	X
44	X	X	X	X	X	X	X	X	X	X	X	X
46	X	X	X	X	X	X	X	X	X	X	X	X
48	X	X	X	X	X	X	X	X	X	X	X	X

4 - 16

Available Finishes		Available Accessories	
Steel - Standard		XG-OBD	Steel Opposed Blade Damper
01	White	XG-SAB	Steel Anchor Bars
Steel - Optional		XG-SBR	Steel Security Bars
02	Satin Silver	XG-LSA	Loose Steel Angle
03	Black	XG-BSA	Bolted Steel Angle
28	Custom Color	XG-WSA	Welded Steel Angle
		XG-SH	Screw Holes In Face

SERIES XG-SGRH PERFORMANCE DATA
MODEL XG-SGRH

Size (in)	NK Vel	100	150	200	250	300	350	400	450	500	600	700
Neck Area ft ²	Ps	.002	.004	.008	.012	.018	.024	.032	.040	.049	.071	.096
06x06 .250	CFM	25	38	50	63	75	88	100	113	125	150	175
	NC	-	-	-	-	-	-	11	18	21	27	31
08x06 .333	CFM	34	50	67	84	100	117	134	150	167	200	234
	NC	-	-	-	-	-	12	16	19	22	28	32
08x08 .444	CFM	45	67	89	111	134	156	178	200	222	267	311
	NC	-	-	-	-	-	13	17	20	24	29	34
09x06 .375	CFM	38	57	75	94	113	132	150	169	188	225	263
	NC	-	-	-	-	-	12	16	20	23	28	33
09x09 .563	CFM	57	85	113	141	169	198	226	254	282	338	395
	NC	-	-	-	-	-	14	18	22	25	30	35
10x06 .417	CFM	42	63	84	105	126	146	167	188	209	251	292
	NC	-	-	-	-	-	13	17	20	23	29	33
10x10 .694	CFM	70	105	139	174	209	243	278	313	347	417	486
	NC	-	-	-	-	-	15	19	22	26	31	36
12x06 .500	CFM	50	75	100	125	150	175	200	225	250	300	350
	NC	-	-	-	-	-	13	17	21	24	30	34
12x08 .667	CFM	67	101	134	167	201	234	267	301	334	401	467
	NC	-	-	-	-	-	15	19	22	25	31	36
12x10 .833	CFM	84	125	167	209	250	292	334	375	417	500	584
	NC	-	-	-	-	11	16	20	23	26	32	36
12x12 1.000	CFM	100	150	200	250	300	350	400	450	500	600	700
	NC	-	-	-	-	12	16	20	24	27	33	37
14x14 1.361	CFM	137	205	273	341	409	477	545	613	681	817	953
	NC	-	-	-	-	13	18	22	25	29	34	39
15x15 1.563	CFM	157	235	313	391	469	548	626	704	782	938	1095
	NC	-	-	-	-	14	18	22	26	29	35	39
16x12 1.333	CFM	134	200	267	334	400	467	534	600	667	800	934
	NC	-	-	-	-	13	18	22	25	28	34	38
16x16 1.778	CFM	178	267	356	445	534	623	712	801	889	1067	1245
	NC	-	-	-	-	14	19	23	26	30	35	40
18x06 .750	CFM	75	113	150	188	225	263	300	338	375	450	525
	NC	-	-	-	-	11	15	19	23	26	31	36
18x08 1.000	CFM	100	150	200	250	300	350	400	450	500	600	700
	NC	-	-	-	-	12	16	20	24	27	33	37
18x15 1.875	CFM	188	282	375	469	563	657	750	844	938	1125	1313
	NC	-	-	-	-	15	19	23	27	30	35	40

SERIES XG-SGRH PERFORMANCE DATA
MODEL XG-SGRH

Size (in)	NK Vel	100	150	200	250	300	350	400	450	500	600	700
Neck Area ft ²	Ps	.002	.004	.008	.012	.018	.024	.032	.040	.049	.071	.096
18x18 2.250	CFM	225	338	450	563	675	788	900	1013	1125	1350	1575
	NC	-	-	-	-	15	20	24	27	31	36	41
20x20 2.778	CFM	278	417	556	695	834	973	1112	1251	1389	1667	1945
	NC	-	-	-	11	16	21	25	28	32	37	42
21x12 1.750	CFM	175	263	350	438	525	613	700	788	875	1050	1225
	NC	-	-	-	-	14	19	23	26	30	35	40
21x21 3.063	CFM	307	460	613	766	919	1073	1226	1379	1532	1838	2145
	NC	-	-	-	11	17	21	25	29	32	37	42
22x22 3.361	CFM	337	505	673	841	1009	1177	1345	1513	1681	2017	2353
	NC	-	-	-	12	17	22	26	29	32	38	43
24x08 1.333	CFM	134	200	267	334	400	467	534	600	667	800	934
	NC	-	-	-	-	13	18	22	25	28	34	38
24x12 2.000	CFM	200	300	400	500	600	700	800	900	1000	1200	1400
	NC	-	-	-	-	15	19	23	27	30	36	40
24x15 2.500	CFM	250	375	500	625	750	875	1000	1125	1250	1500	1750
	NC	-	-	-	-	16	20	24	28	31	37	41

PERFORMANCE NOTES FOR SERIES XG-SGRH

All data is tested in accordance with ANSI/ASHRAE 70-2006.

DEFINITION OF UNITS

CFM Cubic Feet per Minute (air)

Nk Vel Neck Velocity is the airstream velocity in the duct just before it reaches the supply outlet; measured in Feet per Minute

Ps Static pressure = Pt-Pv (inches of water column)

NC Noise criterion, sound pressure level NC ratings are based on sound power level (Lw) re: 10⁻¹² watts minus a 10dB room attenuation in all octave bands

MODEL XG-SGWM

Maximum Security Supply Grilles – XG-SGWM with Woven Mesh

XG-SGWM - Steel

XG-SGWM - Stainless Steel

Air diffusers shall be model XG-SGWM manufactured by GREENHECK. Units shall be medium security grilles of steel construction with a face plate constructed of 12-gauge steel backed by a 10-gauge woven mesh screen. The face shall be stitch welded to the 12-gauge sleeve. Units shall have a 1” border.

The units shall be the size and quantity as outlined in the plans and specifications. Optional opposed blade damper shall be constructed of steel (model XG-OBD).

Rear operation of the damper is recommended.

Performance Specification

The manufacturer shall provide published performance data. Data shall be tested in accordance to ANSI/ ASHRAE Standard 70-2006.

Paint Specification

Process shall be anodic electro-deposition using an anodic acrylic paint. Units shall undergo pre-treatment including a pressurized spray stage using an alkaline cleaner and a de-ionized water rinse.

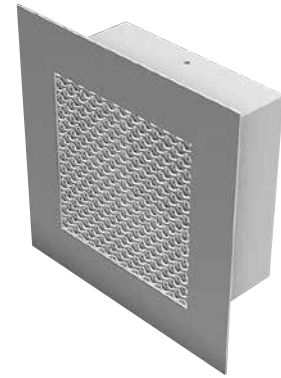

MODEL XG-SGWM

Maximum Security Barrier Grilles Steel Wired Mesh

Models: **XG-SGWM** .125" Steel Wire Mesh in a 1" Flanged Frame for Duct Mounting

XG-SGWM - 1/8" Wired Mesh in a 1" Flange Frame for Duct Mounting

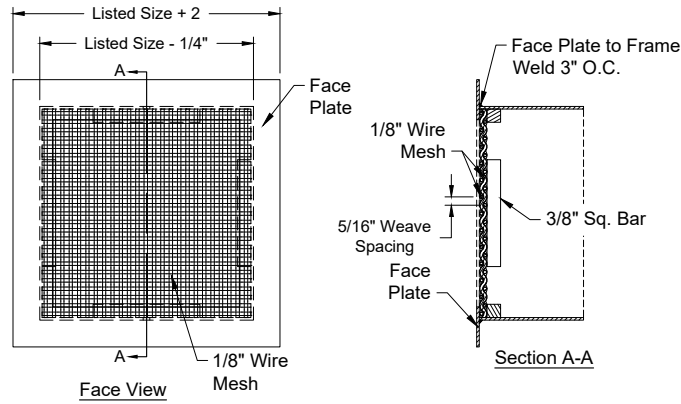

OPTIONS

XG-OBD or XG-OBDA

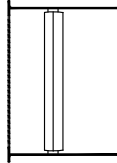

Rear
Operated
Opposed
Blades

XG-SAB

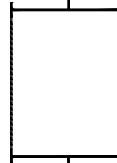

1/2
Diameter 3"
Long For Concrete
Block Or Brick Wall.

XG-SBR

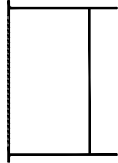

1/2
Diameter Bar On
Maximum 6" Centers
Welded To Sleeve

XG-LSA (showed XG-LSA-4)

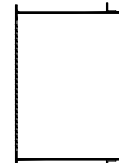

4pcs. L1" x 1" x 3/16"
2 Long; 2 Short Dimension
Shipped loose for field welding.

XG-BSA

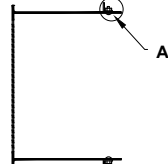

L1" x 1" x 3/16"
Angle mounting holes punched
1" from each end of the angle
for field installation
Customer to use the angle mounting

XG-WSA

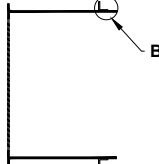

L1" x 1" x 3/16"
Angles Welded
To Sleeve

XG-WAF

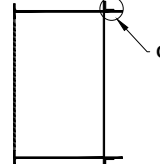

L1" x 1" x 3/16"
Welded Angle Flange
(Shipped Loose)



Detail A



Detail B



Detail C

**XG-SGWM MODEL NUMBER SPECIFICATION
MEDIUM SECURITY RETURN GRILLE**

Model	Neck														Sleeve	
	XG-SGWM	6	8	9	10	12	14	15	16	18	20	21	22	24		26
6	X	X	X	X	X	X	X	X	X	X	X	X	X	X	X	4 - 16
8		X	X	X	X	X	X	X	X	X	X	X	X	X	X	
9			X	X	X	X	X	X	X	X	X	X	X	X	X	
10				X	X	X	X	X	X	X	X	X	X	X	X	
12					X	X	X	X	X	X	X	X	X	X	X	
14						X	X	X	X	X	X	X	X	X	X	
15							X	X	X	X	X	X	X	X	X	
16								X	X	X	X	X	X	X	X	
18									X	X	X	X	X	X	X	
20										X	X	X	X	X	X	
21											X	X	X	X	X	
22												X	X	X	X	
24													X	X	X	
26														X	X	

Finishes		Accessories - Steel	
Steel - Standard		XG-OB	Steel Opposed Blade Damper
01	White	XG-SAB	Steel Anchor Bars
Steel - Optional		XG-SBR	Steel Security Bars
02	Satin Silver	XG-LSA	Loose Steel Angle
03	Black	XG-BSA	Bolted Steel Angle
28	Custom Color	XG-WSA	Welded Steel Angle
		XG-WAF	Welded Steel Angle Frame
		XG-SH	Screw Holes In Face

XG-SGWM MODEL NUMBER SPECIFICATION
MEDIUM SECURITY RETURN GRILLE

Model	Neck												Sleeve
	28	30	32	34	36	38	40	42	44	46	48		
SXG-GWM													
6	X	X	X	X	X	X	X	X	X	X	X	X	4 - 16
8	X	X	X	X	X	X	X	X	X	X	X	X	
9	X	X	X	X	X	X	X	X	X	X	X	X	
10	X	X	X	X	X	X	X	X	X	X	X	X	
12	X	X	X	X	X	X	X	X	X	X	X	X	
14	X	X	X	X	X	X	X	X	X	X	X	X	
15	X	X	X	X	X	X	X	X	X	X	X	X	
16	X	X	X	X	X	X	X	X	X	X	X	X	
18	X	X	X	X	X	X	X	X	X	X	X	X	
20	X	X	X	X	X	X	X	X	X	X	X	X	
21	X	X	X	X	X	X	X	X	X	X	X	X	
22	X	X	X	X	X	X	X	X	X	X	X	X	
24	X	X	X	X	X	X	X	X	X	X	X	X	
26	X	X	X	X	X	X	X	X	X	X	X	X	
28	X	X	X	X	X	X	X	X	X	X	X	X	
30		X	X	X	X	X	X	X	X	X	X	X	
32			X	X	X	X	X	X	X	X	X	X	
34				X	X	X	X	X	X	X	X	X	
36					X	X	X	X	X	X	X	X	
38						X	X	X	X	X	X	X	
40							X	X	X	X	X	X	
42								X	X	X	X	X	
44									X	X	X	X	
46										X	X	X	
48											X	X	

Available Finishes		Available Accessories - Steel	
Steel - Standard		XG-OBD	Steel Opposed Blade Damper
01	White	XG-SAB	Steel Anchor Bars
Steel - Optional		XG-SBR	Steel Security Bars
02	Satin Silver	XG-LSA	Loose Steel Angle
03	Black	XG-BSA	Bolted Steel Angle
28	Custom Color	XG-WSA	Welded Steel Angle
		XG-WAF	Welded Steel Angle Frame
		XG-SH	Screw Holes In Face

SERIES XG-SGWM PERFORMANCE DATA
MODEL XG-SGWM

Size (in)	NK Vel	100	150	200	250	300	350	400	450	500	600	700
Neck Area ft ²	Ps	.003	.006	.010	.016	.023	.031	.040	.051	.063	.071	.096
06x06 .250	CFM	19	29	38	48	57	67	76	86	95	114	133
	NC	-	-	-	-	-	-	-	11	13	16	18
08x06 .333	CFM	27	40	53	67	80	93	106	120	133	159	186
	NC	-	-	-	-	-	-	11	13	15	17	20
08x08 .444	CFM	37	55	73	91	109	128	146	164	182	218	255
	NC	-	-	-	-	-	-	12	14	16	19	21
09x06 .375	CFM	30	45	60	75	90	105	120	135	150	180	210
	NC	-	-	-	-	-	-	12	13	15	18	20
09x09 .563	CFM	48	71	95	118	142	165	189	212	236	283	330
	NC	-	-	-	-	-	12	14	15	17	20	22
10x06 .417	CFM	34	51	68	85	102	119	136	153	169	203	237
	NC	-	-	-	-	-	-	12	14	16	19	21
10x10 .694	CFM	60	89	119	149	178	208	238	267	297	356	416
	NC	-	-	-	-	-	13	15	16	18	21	23
12x06 .500	CFM	41	62	82	103	123	144	164	185	205	246	287
	NC	-	-	-	-	-	11	13	15	16	19	22
12x08 .667	CFM	57	85	113	142	170	198	226	255	283	339	396
	NC	-	-	-	-	-	12	14	16	18	21	23
12x10 .833	CFM	73	109	145	181	217	253	289	325	361	433	505
	NC	-	-	-	-	11	13	15	17	19	22	24
12x12 1.000	CFM	88	132	176	220	264	308	352	396	440	528	616
	NC	-	-	-	-	12	14	16	18	20	23	25
14x14 1.361	CFM	122	183	244	305	366	427	488	549	610	732	854
	NC	-	-	-	-	13	16	18	20	21	24	26
15x15 1.563	CFM	141	212	282	353	423	494	564	635	705	846	987
	NC	-	-	-	11	14	16	18	20	22	25	27
16x12 1.333	CFM	120	179	239	298	358	417	477	536	596	715	834
	NC	-	-	-	-	13	16	18	19	21	24	26
16x16 1.778	CFM	162	243	324	404	485	566	647	728	808	970	1132
	NC	-	-	-	12	15	17	19	21	22	25	28
18x06 .750	CFM	63	95	126	157	189	220	252	283	314	377	440
	NC	-	-	-	-	-	13	15	17	18	21	24

CONTINUED

SERIES XG-SGWM PERFORMANCE DATA
MODEL XG-SGWM

Size (in)	NK Vel	100	150	200	250	300	350	400	450	500	600	700
Neck Area ft ²	Ps	.003	.006	.010	.016	.023	.031	.040	.051	.063	.071	.096
18x08 1.000	CFM	87	131	174	217	261	304	348	391	434	521	608
	NC	-	-	-	-	12	14	16	18	20	23	25
18x15 1.875	CFM	171	256	341	427	512	597	682	768	853	1023	1194
	NC	-	-	-	12	15	17	19	21	23	25	28
18x18 2.250	CFM	207	310	413	516	620	723	826	929	1032	1239	1445
	NC	-	-	-	13	16	18	20	22	23	26	27
20x20 2.778	CFM	258	387	515	644	773	901	1030	1159	1287	1545	1802
	NC	-	-	-	14	17	19	21	23	24	27	30
21x12 1.750	CFM	159	238	317	396	475	554	633	712	791	950	1108
	NC	-	-	-	12	14	17	19	21	22	25	28
21x21 3.063	CFM	285	428	570	713	855	998	1140	1283	1425	1710	1995
	NC	-	-	11	14	17	19	21	23	25	28	30
22x22 3.361	CFM	314	471	627	784	941	1097	1254	1411	1567	1881	2194
	NC	-	-	11	15	17	20	22	24	25	28	31
24x08 1.333	CFM	117	176	234	293	351	410	468	527	585	702	819
	NC	-	-	-	-	13	16	18	19	21	24	26
24x12 2.000	CFM	182	273	364	455	546	637	728	819	909	1091	1273
	NC	-	-	-	12	15	17	20	21	23	26	28
24x15 2.500	CFM	230	345	460	575	690	805	920	1035	1150	1380	1610
	NC	-	-	-	13	16	18	21	22	24	27	29
24x18 3.000	CFM	279	418	557	696	836	975	1114	1253	1392	1671	1949
	NC	-	-	11	14	17	19	21	23	25	28	30
24x24 4.000	CFM	376	564	752	939	1127	1315	1503	1691	1878	2254	2630
	NC	-	-	12	15	18	21	23	24	26	29	31
26x26 4.694	CFM	444	666	888	1110	1332	1554	1776	1998	2219	2663	3107
	NC	-	-	13	16	19	21	23	25	27	30	32
28x18 3.500	CFM	327	491	654	817	981	1144	1308	1471	1634	1961	2288
	NC	-	-	11	15	18	20	22	24	26	28	31
28x28 5.440	CFM	516	773	1031	1288	1546	1804	2061	2319	2576	3092	3607
	NC	-	-	13	17	20	22	24	26	27	30	33
30x12 2.500	CFM	229	343	457	571	686	800	914	1028	1142	1371	1599
	NC	-	-	-	13	16	18	20	22	24	27	29

CONTINUED

SERIES XG-SGWM PERFORMANCE DATA
MODEL XG-SGWM

Size (in)	NK Vel	100	150	200	250	300	350	400	450	500	600	700
Neck Area ft ²	Ps	.003	.006	.010	.016	.023	.031	.040	.051	.063	.071	.096
30x24 5.000	CFM	472	708	944	1180	1416	1652	1888	2124	2359	2831	3303
	NC	-	-	13	16	19	22	24	25	27	30	32
30x30 6.250	CFM	595	892	1190	1487	1784	2082	2379	2676	2973	3568	4163
	NC	-	-	14	17	20	23	25	26	28	31	33
36x12 3.000	CFM	276	413	551	688	826	964	1101	1239	1376	1652	1927
	NC	-	-	11	14	17	19	21	23	25	28	30
36x24 6.000	CFM	569	853	1138	1422	1706	1991	2275	2559	2843	3412	3981
	NC	-	-	14	17	20	22	24	26	28	31	33
36x30 7.500	CFM	716	1074	1431	1789	2147	2504	2862	3220	3577	4293	5008
	NC	-	-	15	18	21	23	25	27	29	32	34
36x36 9.000	CFM	863	1294	1725	2156	2588	3019	3450	3881	4312	5175	6037
	NC	-	11	16	19	22	24	26	28	30	33	35
48x12 4.000	CFM	369	554	738	922	1107	1291	1476	1660	1844	2213	2582
	NC	-	-	12	15	18	20	23	24	26	29	31
48x24 8.000	CFM	763	1144	1526	1907	2288	2670	3051	3432	3813	4576	5339
	NC	-	11	15	18	21	24	26	28	29	32	34
48x36 12.000	CFM	1158	1737	2316	2894	3473	4052	4631	5210	5788	6946	8104
	NC	-	12	17	20	23	25	18	29	31	34	36
48x48 16.000	CFM	1550	2325	3100	3875	4650	5425	6200	6975	7750	9300	10850
	NC	-	14	18	22	24	27	29	31	32	35	37

PERFORMANCE NOTES FOR SERIES XG-SGWM

All data is tested in accordance with ANSI/ASHRAE 70-2006

DEFINITION OF UNITS

CFM Cubic Feet per Minute (air)

Nk Vel Neck Velocity is the airstream velocity in the duct just before it reaches the supply outlet; measured in Feet per Minute

NC Noise criterion, sound pressure level NC ratings are based on sound power level (Lw) re: 10⁻¹² watts minus a 10dB room attenuation in all octave bands

Ps Static pressure = Pt-Pv (inches of water column)

MODEL XG-SG5500

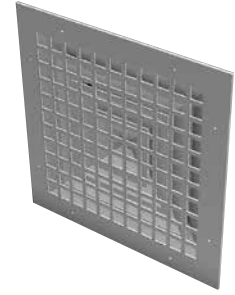

Air outlets shall be model XG-SG-5500S manufactured by GREENHECK. Units shall be minimum security supply ceiling diffusers construction of steel Units shall consist of a 12 gauge steel lattice face panel with 13/16" square holes and 3/16" fret bars mounted in front of a fixed pattern louvered core fastened into a border with spring loaded latches. Units shall be furnished with screw holes for tamper proof screws (provided by others). With the face lattice face removed, the core shall be removable without the use of tools.

Outlets shall be engineered to perform in variable volume systems and include deflector blades with a horizontal lip to provide longer throw distances The units shall be the size and quantity as outline in the plans and specifications.

Outlets shall be available in 1, 2 way opposite, 2 way corner, 3, and 4 way directional air patterns. The units shall be the size and quantity as outline in the plans and specifications.

Optional opposed blade damper shall be constructed of steel (model XG-OBD) or aluminum (model XG-OBDA). Damper must be operable from the face of the diffuser.

Performance Specification

The manufacturer shall provide published performance data. Data shall be tested in accordance to ANSI/ASHRAE Standard 70- 2006.

Minimum Security Diffuser Steel

Models: **XG-SG5500S-1** Diffuser and Face Plate - Surface Mount
 Option: **XG-SG5500S-1 D5** Diffuser And Face Plate - With Steel Neck Mounted Damper - Surface Mount
XG-SG5500S-1 D5A Diffuser And Face Plate - With Aluminum Neck Mounted Damper - Surface Mount

Model: XG-SG5500S-1 (Minimum Security Diffuser And Face Plate - Surface Mount)

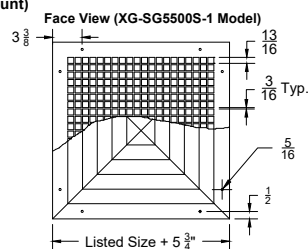
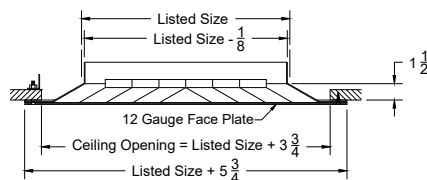

SG5LFP - Steel Face Plate for XG-SG5500S

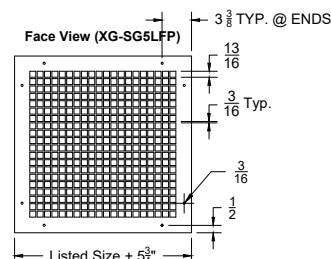

Model: XG-SG5500S-1 D5
 (Minimum Security Diffuser And Face Plate - Surface Mount) - With D5 Steel Neck Mount Damper

Model: XG-SG5500S-1 D5A
 (Minimum Security Diffuser And Face Plate - Surface Mount) - With D5A Aluminum Neck Mount Damper

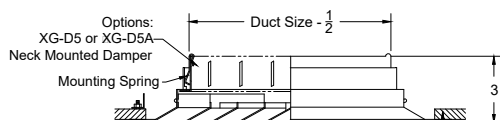

**XG-SG5500 MODEL NUMBER SPECIFICATION
MINIMUM SECURITY LOUVER/LATTICE FACE GRILLE**

Model	Neck								Sleeve	Available Finishes	
	6	9	12	15	18	21	24				
XG-SG5500S									4 - 16	Steel - Standard	
XG-SG55000AL	6	X	X	X	X	X	X	X		01	White
XG-SG5500SS	9		X	X	X	X	X	X		Steel - Optional	
	12			X	X	X	X	X		02	Satin Silver
	15				X	X	X	X		03	Black
	18					X	X	X		28	Custom Color
	21						X	X		Stainless Steel - Standard	
	24							X		23	Satin Polish
	27									Stainless Steel - Optional	
	30									01	White Painted
									02	Satin Silver Painted	
									03	Black Painted	
									28	Custom Color	

Available Accessories - Steel		Available Accessories - Stainless Steel	
XG-OBD	Steel Opposed Blade Damper	XG-OBD-SS	Stainless Steel Opposed Blade Damper
XG-SAB	Steel Anchor Bars	XG-SAB-SS	Stainless Steel Anchor Bars
XG-SBR	Steel Security Bars	XG-SBR-SS	Stainless Steel Security Bars
XG-LSA	Loose Steel Angle	XG-LSA-SS	Loose Stainless Steel Angle
XG-BSA	Bolted Steel Angle	XG-BSA-SS	Bolted Stainless Steel Angle
XG-WSA	Welded Steel Angle	XG-WSA-SS	Welded Stainless Steel Angle
XG-WAF	Welded Steel Angle Frame	XG-WAF-SS	Welded Stainless Steel Angle Frame
XG-SH	Optional Screw Holes In Face	XG-316-SS	316 Stainless Steel

SERIES XG-SG5500 PERFORMANCE DATA
MODELS XG-SG5500S/XG-SG5500AL/XG-SG5500SS

Size (in)	Nk Vel	100	150	200	250	300	350	400	450	500	600	700
Neck Area ft ²	Ps	.002	.004	.008	.012	.018	.024	.032	.040	.049	.071	.096
06x06 .250	CFM	25	38	50	63	75	88	100	113	125	150	175
	Throws	1-2	1-2	1-3	1-4	1-5	2-6	3-7	3-8	3-9	4-11	5-12
	NC	-	-	-	-	-	11	15	19	23	29	33
09x09 .563	CFM	56	84	113	141	169	197	225	253	282	338	394
	Throws	1-2	1-3	1-5	2-6	3-8	4-10	5-12	6-13	7-14	8-16	8-18
	NC	-	-	-	-	12	17	22	26	29	35	40
12x12 1.000	CFM	100	150	200	250	300	350	400	450	500	600	700
	Throws	1-2	1-4	2-6	3-7	4-9	5-10	6-13	6-14	7-16	9-21	10-23
	NC	-	-	-	14	17	22	26	30	33	39	44
15x15 1.563	CFM	156	234	313	391	469	547	625	703	782	938	1094
	Throws	1-4	1-6	2-8	3-10	4-12	5-14	8-16	9-20	10-23	11-27	10-30
	NC	-	-	-	15	20	25	29	33	36	42	47
18x18 2.250	CFM	225	338	450	563	675	788	900	1013	1125	1350	1575
	Throws	1-4	2-7	3-11	3-14	4-16	6-19	8-22	10-25	11-28	13-32	14-36
	NC	-	-	11	18	24	29	33	37	40	46	50
21x21 3.063	CFM	306	459	613	766	919	1072	1225	1378	1532	1838	2144
	Throws	1-5	2-9	3-13	5-16	7-19	8-22	10-25	12-28	13-30	15-37	17-42
	NC	-	-	13	20	26	31	35	39	42	47	53
24x24 4.000	CFM	400	600	800	1000	1200	1400	1600	1800	2000	2400	2800
	Throws	1-5	2-9	4-14	6-18	8-22	10-25	12-29	14-32	16-36	18-43	20-47
	NC	-	-	15	22	28	33	37	41	44	50	54

PERFORMANCE NOTES FOR SERIES XG-SG5500

All data is tested in accordance with ANSI/ASHRAE 70-2006.

DEFINITION OF UNITS

CFM Cubic Feet per Minute (air)

Ps Static pressure = $P_t - P_v$ (inches of water column)

Throw Throw distance in feet are for terminal velocities of 150 and 50 fpm respectively (4 Way Air Flow)NC

NC Noise criterion, sound pressure level ratings are based on sound power level (Lw) re: 10^{-12} watts minus a 10dB room attenuation in all octave bands

Nk Vel Neck Velocity is the airstream velocity in the duct just before it reaches the supply outlet; measured in feet per minute

MODEL XG-SGRP-AL

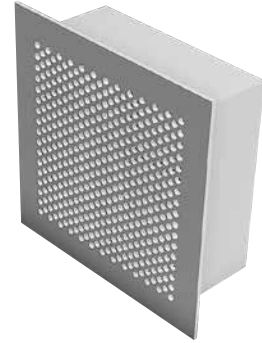

The XG-SGRP-AL minimum security grille is designed to create a barrier to the ductwork behind the grille. The XG-SGRP-AL is constructed with an aluminum face plate welded to an aluminum sleeve.

- 1/8" aluminum face plate
- 5/16" holes on 7/16" center
- Optional continuously welded seams

XG-SGRP-AL MODEL NUMBER SPECIFICATION MINIMUM SECURITY — 5/16" PERFORATED FACE WITH 7/16" STAGGERED CENTERS

Model	Neck																Sleeve
	6	8	9	10	12	14	15	16	18	20	21	22	24	26	28	30	
XG-SGRP-AL	X	X	X	X	X	X	X	X	X	X	X	X	X	X	X	X	X
6		X	X	X	X	X	X	X	X	X	X	X	X	X	X	X	X
8			X	X	X	X	X	X	X	X	X	X	X	X	X	X	X
9				X	X	X	X	X	X	X	X	X	X	X	X	X	X
10					X	X	X	X	X	X	X	X	X	X	X	X	X
12						X	X	X	X	X	X	X	X	X	X	X	X
14							X	X	X	X	X	X	X	X	X	X	X
15								X	X	X	X	X	X	X	X	X	X
16									X	X	X	X	X	X	X	X	X
18										X	X	X	X	X	X	X	X
20											X	X	X	X	X	X	X
21												X	X	X	X	X	X
22													X	X	X	X	X
24														X	X	X	X
26															X	X	X
28																X	X
30																	X

Available Finishes		Available Accessories - Aluminum	
Steel - Standard		XG-OBDA	Opposed Blade Damper
01	White	XG-AAB	Anchor Bars
Steel - Optional		XG-SBR-AL	Security Bars
02	Satin Silver	XG-LALA	Loose Angle
03	Black	XG-BALA	Bolted Angle
28	Custom Color	XG-WALA	Welded Angle
		XG-WAF-AL	Welded Angle Frame

SERIES XG-SGRP-AL PERFORMANCE DATA
MODEL XG-SGRP-AL

Size (in)	NK Vel	100	150	200	250	300	350	400	450	500	600	700
Neck Area ft ²	Ps	.002	.004	.008	.012	.018	.024	.032	.040	.049	.071	.096
06x06 .250	CFM	25	38	50	63	75	88	100	113	125	150	175
	Throws	1-5	2-7	3-10	4-12	5-13	6-15	6-16	7-17	8-17	10-19	11-21
	NC	-	-	-	-	11	15	19	23	26	31	36
08x06 .333	CFM	34	50	67	84	100	117	134	150	167	200	234
	Throws	1-5	2-8	4-11	5-14	6-16	6-17	7-18	8-19	9-20	11-22	13-24
	NC	-	-	-	-	12	16	20	24	27	33	37
08x08 .444	CFM	45	67	89	111	134	156	178	200	222	267	311
	Throws	1-6	3-9	4-13	5-16	6-18	7-19	8-21	10-22	11-23	13-25	15-27
	NC	-	-	-	-	13	18	22	25	26	34	38
09x06 .375	CFM	38	57	75	94	113	132	150	169	188	225	263
	Throws	1-6	3-9	4-12	5-15	6-17	7-18	8-19	9-20	10-21	12-23	14-25
	NC	-	-	-	-	12	17	21	25	28	33	38
09x09 .563	CFM	57	85	113	141	169	198	226	254	282	338	395
	Throws	1-7	3-11	5-14	6-18	7-20	8-22	10-23	11-25	12-26	14-29	17-31
	NC	-	-	-	-	14	19	23	26	29	35	39
10x06 .417	CFM	42	63	84	105	126	146	167	188	209	251	292
	Throws	1-6	3-9	4-12	5-15	6-17	7-19	8-20	9-21	10-22	12-25	14-27
	NC	-	-	-	-	13	18	21	25	28	34	38
10x08 .556	CFM	56	84	112	139	167	195	223	251	278	334	390
	Throws	1-7	3-11	5-14	6-18	7-20	8-22	9-23	11-25	12-26	14-28	17-31
	NC	-	-	-	-	14	19	23	26	29	35	39
10x10 .694	CFM	70	105	139	174	209	243	278	313	347	417	486
	Throws	1-8	3-12	5-16	7-20	8-22	9-24	11-26	12-27	13-29	16-32	19-34
	NC	-	-	-	-	15	20	24	27	30	36	40
12x06 .500	CFM	50	75	100	125	150	175	200	225	250	300	350
	Throws	1-7	3-10	5-14	6-17	7-19	8-21	9-22	10-21	11-25	14-27	16-29
	NC	-	-	-	-	14	18	22	26	29	34	39
12x08 .667	CFM	67	101	134	167	201	234	267	301	334	401	467
	Throws	1-8	3-12	5-16	7-20	8-22	9-24	10-25	12-27	13-28	16-31	18-34
	NC	-	-	-	-	15	20	23	27	30	36	40
12x10 .833	CFM	84	125	167	209	250	292	334	375	417	500	584
	Throws	2-9	4-13	6-17	7-12	9-25	10-27	12-28	13-30	15-32	17-35	20-38
	NC	-	-	-	-	16	20	24	28	31	37	41
12x12 1.000	CFM	100	150	200	250	300	350	400	450	500	600	700
	Throws	2-10	4-14	6-19	8-24	10-27	11-29	13-31	14-33	16-35	19-38	22-41
	NC	-	-	-	11	17	21	25	29	32	37	42

CONTINUED

SERIES XG-SGRP-AL PERFORMANCE DATA
MODEL XG-SGRP-AL

Size (in)	NK Vel	100	150	200	250	300	350	400	450	500	600	700
Neck Area ft ²	Ps	.002	.004	.008	.012	.018	.024	.032	.040	.049	.071	.096
14x08 .778	CFM	78	117	156	195	234	273	312	351	389	467	545
	Throws	2-8	4-13	6-17	7-21	8-24	10-26	11-27	13-29	14-31	17-34	20-36
	NC	-	-	-	-	16	20	24	28	31	36	41
14x14 1.361	CFM	137	205	273	341	409	477	545	613	681	817	953
	Throws	2-11	5-17	7-22	9-28	11-31	13-34	15-36	17-39	19-41	22-44	27-49
	NC	-	-	-	12	18	23	27	30	33	39	44
15x15 1.563	CFM	157	235	313	391	469	548	626	704	782	938	1095
	Throws	2-12	5-18	8-24	10-30	12-34	14-36	16-39	18-41	20-44	24-48	28-51
	NC	-	-	-	13	19	23	27	31	34	39	44
16x10 1.111	CFM	112	167	223	278	334	389	445	500	556	667	778
	Throws	2-10	4-15	7-20	8-25	10-28	12-31	13-33	15-35	17-37	20-40	23-43
	NC	-	-	-	12	17	22	26	29	32	38	42
16x12 1.333	CFM	134	200	267	334	400	467	534	600	667	800	934
	Throws	2-11	5-17	7-22	9-28	11-31	13-34	15-36	17-38	18-40	22-44	26-48
	NC	-	-	-	12	18	22	26	30	33	39	43
16x16 1.778	CFM	178	267	356	445	534	623	712	801	889	1067	1245
	Throws	2-13	5-19	8-25	11-32	13-36	15-39	17-41	19-44	21-46	25-51	30-55
	NC	-	-	-	14	19	24	28	31	34	40	44

PERFORMANCE NOTES FOR SERIES XG-SGRP-AL

All data is tested in accordance with ANSI/ASHRAE 70-2006.

DEFINITION OF UNITS

CFM Cubic Feet per Minute (air)

Nk Vel Neck Velocity is the airstream velocity in the duct just before it reaches the supply outlet; measured in Feet per Minute

NC Noise criterion, sound pressure level NC ratings are based on sound power level (Lw) re: 10⁻¹² watts minus a 10dB room attenuation in all octave bands

Throw Throw distance in feet are for terminal velocities of 50 and 100fpm respectively

Ps Static pressure = Pt-Pv (inches of water column)

SERIES XG-SGRP-AL PERFORMANCE DATA
MODEL XG-SGRP-AL

Size (in)	NK Vel	100	150	200	250	300	350	400	450	500	600	700
Neck Area ft ²	Ps	.002	.005	.009	.014	.020	.026	.035	.044	.054	.078	.106
18x12 1.500	CFM	150	225	300	375	450	525	600	675	750	900	1050
	Throws	2-12	5-18	8-23	10-29	12-33	14-36	16-38	18-40	19-43	23-47	27-50
	NC	-	-	-	16	21	26	30	33	37	42	47
18x18 2.250	CFM	225	338	450	563	675	788	900	1013	1125	1350	1575
	Throws	3-14	6-21	10-29	12-36	14-40	17-44	19-47	21-50	24-52	29-57	33-62
	NC	-	-	11	18	23	28	32	35	38	44	48
20x20 2.778	CFM	278	417	556	695	834	973	1112	1251	1389	1667	1945
	Throws	3-16	7-24	11-32	13-40	16-25	19-49	21-52	24-55	27-58	32-64	37-69
	NC	-	-	12	19	24	29	33	36	39	45	49
21x21 3.063	CFM	307	460	613	766	919	1073	1226	1379	1532	1838	2145
	Throws	3-17	7-25	11-33	14-42	17-47	19-51	22-54	25-58	28-61	33-67	39-72
	NC	-	-	12	19	24	29	33	37	40	45	50
22x22 3.361	CFM	337	505	673	841	1009	1177	1345	1513	1681	2017	2353
	Throws	3-17	7-26	12-35	15-44	18-49	20-53	23-57	26-61	29-64	35-70	41-75
	NC	-	-	13	19	25	29	33	37	40	46	50
24x06 1.000	CFM	100	150	200	250	300	350	400	450	500	600	700
	Throws	2-10	4-14	6-19	8-24	10-27	11-29	13-31	14-33	16-35	19-38	22-41
	NC	-	-	-	14	20	24	28	32	35	40	45
24x08 1.333	CFM	134	200	267	334	400	467	534	600	667	800	934
	Throws	2-11	5-17	7-22	9-28	11-31	13-34	15-36	17-38	18-40	22-44	26-48
	NC	-	-	-	15	21	25	29	33	36	42	46
24x12 2.000	CFM	200	300	400	500	600	700	800	900	1000	1200	1400
	Throws	3-14	6-20	9-27	11-34	14-38	16-41	18-44	20-47	23-49	27-54	32-58
	NC	-	-	-	17	23	27	31	35	38	43	48
24x18 3.000	CFM	300	450	600	750	900	1050	1200	1350	1500	1800	2100
	Throws	3-17	7-25	11-33	14-41	17-47	19-50	22-54	25-57	28-61	33-66	39-71
	NC	-	-	12	19	24	29	33	36	40	45	50
24x24 4.000	CFM	400	600	800	1000	1200	1400	1600	1800	2000	2400	2800
	Throws	4-19	8-29	13-38	16-48	19-54	22-58	25-62	29-66	32-70	38-76	45-82
	NC	-	-	14	20	26	30	34	38	41	46	51

CONTINUED

SERIES XG-SGRP-AL PERFORMANCE DATA
MODEL XG-SGRP-AL

Size (in)	NK Vel	100	150	200	250	300	350	400	450	500	600	700
Neck Area ft ²	Ps	.002	.005	.009	.014	.020	.026	.035	.044	.054	.078	.106
26x26 4.694	CFM	470	705	939	1174	1409	1643	1878	2113	2347	2817	3286
	Throws	4-21	9-31	14-41	17-52	21-58	24-63	28-67	31-71	34-75	41-83	48-89
	NC	-	-	14	21	26	31	35	38	42	47	52
30x12 2.500	CFM	250	375	500	625	750	875	1000	1125	1250	1500	1750
	Throws	3-15	6-23	10-30	13-38	15-43	18-46	20-49	23-52	25-55	30-60	35-65
	NC	-	-	11	18	24	28	32	36	39	44	49
30x24 5.000	CFM	500	750	1000	1250	1500	1750	2000	2250	2500	3000	3500
	Throws	4-21	9-32	14-43	18-53	21-60	25-65	28-70	32-74	36-78	43-85	50-92
	NC	-	-	14	21	27	31	35	39	42	47	52
30x30 6.250	CFM	625	938	1250	1563	1875	2188	2500	2813	3125	3750	4375
	Throws	4-24	10-36	16-48	20-60	24-67	28-73	32-78	36-83	40-87	48-95	56-103
	NC	-	-	15	22	28	32	36	40	43	48	53

PERFORMANCE NOTES FOR SERIES XG-SGRP-AL

All data is tested in accordance with ANSI/ASHRAE 70-2006.

DEFINITION OF UNITS

CFM Cubic Feet per Minute (air)

Nk Vel Neck Velocity is the airstream velocity in the duct just before it reaches the supply outlet; measured in Feet per Minute

NC Noise criterion, sound pressure level NC ratings are based on sound power level (Lw) re: 10⁻¹² watts minus a 10dB room attenuation in all octave bands

Throw Throw distance in feet are for terminal velocities of 50 and 100fpm respectively

Ps Static pressure = Pt-Pv (inches of water column)

MODEL XG-SGRP-SR-AL

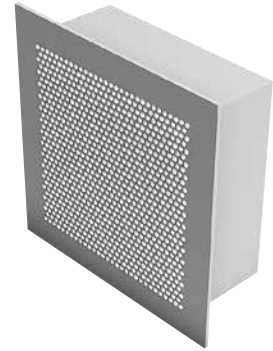

The XG-SGRP-SR-AL is a minimum security grille designed as a suicide deterrent. The small holes inhibit threading objects through the face. The XG-SGRP-SR-AL is constructed with an aluminum plate welded to an aluminum sleeve.

- 1/8" aluminum face plate
- 3/16" holes on 9/32" center
- Continuously welded seams

Minimum Security Aluminum Grille

Models: **XG-SGRP-SR-AL** Minimum Security Aluminum Grille Suicide Deterrent Perforated Face

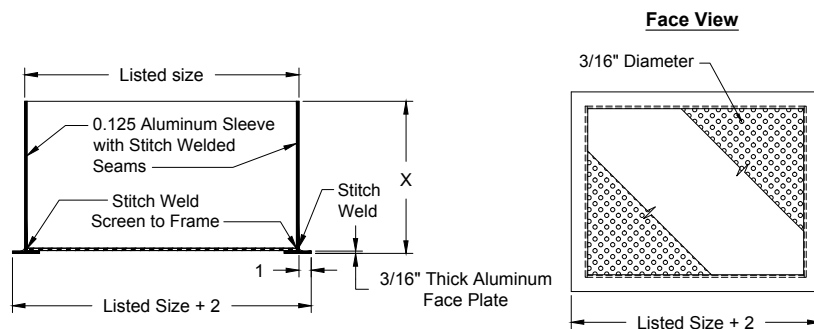

X = Sleeve Length (Has to be specified)

Options

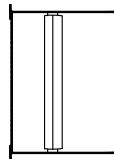
 XG-OBDD

Aluminum Opposed Blade Damper Rear Operated

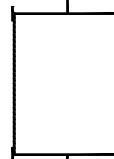
 XG-SAB

Aluminum Anchor Bars 1/2" Diameter 3" Long for Concrete Block or Brick Wall.

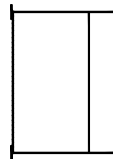
 XG-SBR

Aluminum Security Bars 1/2" Diameter Bar on Maximum 6" Centers Welded to Sleeve Vertical & Horizontal

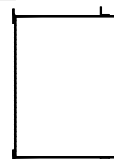
 XG-LSA (showed XG-LSA-4)

Loose Aluminum Angle
 XG-LSA-2S 2 Angles Short Dimension
 XG-SA-2L 2 Angles Long Dimension
 XG-LSA-4 4 Angles, 1" x 1" x 3/16"
 Shipped Loose for field welding

Mounting holes located 1" from edge
 Holes in sleeve drilled where needed
 Hardware provided by others
 (nuts/bolts)

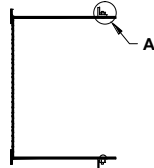
 XG-BSA

Bolted Aluminum Angles
 XG-BSA-2S 2 Angles Short Dimension
 XG-BSA-2L 2 Angles Long Dimension
 XG-BSA-4 4 Angles, 1" x 1" x 3/16"
 Shipped Bolted to Sleeve

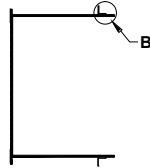
 XG-WSA

Welded Aluminum Angles
 XG-WSA-2S 2 Angles Short Dimension
 XG-WSA-2L 2 Angles Long Dimension
 XG-WSA-4 4 Angles, 1" x 1" x 3/16"
 Shipped Welded To Sleeve

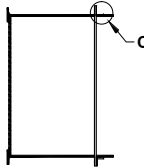
 XG-WAF

1" x 1" x 3/16"
 Welded Steel Angle Flange
 (Shipped Loose)



Detail A



Detail B



Detail C

**XG-SGRP-SR-AL MODEL NUMBER SPECIFICATION
 MINIMUM SECURITY — 3/16" PERFORATED FACE
 WITH 9/32" STAGGERED CENTERS**

Model	Neck																Sleeve
XG-SGRP-SR-AL	6	8	9	10	12	14	15	16	18	20	21	22	24	26	28	30	
6	X	X	X	X	X	X	X	X	X	X	X	X	X	X	X	X	4 - 16
8		X	X	X	X	X	X	X	X	X	X	X	X	X	X	X	
9			X	X	X	X	X	X	X	X	X	X	X	X	X	X	
10				X	X	X	X	X	X	X	X	X	X	X	X	X	
12					X	X	X	X	X	X	X	X	X	X	X	X	
14						X	X	X	X	X	X	X	X	X	X	X	
15							X	X	X	X	X	X	X	X	X	X	
16								X	X	X	X	X	X	X	X	X	
18									X	X	X	X	X	X	X	X	
20										X	X	X	X	X	X	X	
21											X	X	X	X	X	X	
22												X	X	X	X	X	
24													X	X	X	X	
26														X	X	X	
28															X	X	
30																X	

Available Finishes		Available Accessories - Aluminum	
Steel - Standard		XG-OBDA	Opposed Blade Damper
01	White	XG-AAB	Anchor Bars
Steel - Optional		XG-SBR-AL	Security Bars
02	Satin Silver	XG-LALA	Loose Angle
03	Black	XG-BALA	Bolted Angle
28	Custom Color	XG-WALA	Welded Angle
		XG-WAF-AL	Welded Angle Frame

SERIES XG-SGRP PERFORMANCE DATA
MODEL XG-SGRP-SR-AL

Size (in)	NK Vel	100	150	200	250	300	350	400	450	500	600	700
Neck Area ft ²	Ps	.002	.005	.009	.014	.020	.026	.035	.044	.054	.078	.106
06x06 .250	CFM	25	38	50	63	75	88	100	113	125	150	175
	Throws	1-5	2-7	3-10	4-12	5-13	6-15	6-16	7-17	8-17	10-19	11-21
	NC	-	-	-	-	14	18	22	26	29	34	39
08x06 .333	CFM	34	50	67	84	100	117	134	150	167	200	234
	Throws	1-5	2-8	4-11	5-14	6-16	6-17	7-18	8-19	9-20	11-22	13-24
	NC	-	-	-	-	15	19	23	27	30	36	40
08x08 .444	CFM	45	67	89	111	134	156	178	200	222	267	311
	Throws	1-6	3-9	4-13	5-16	6-18	7-19	8-21	10-22	11-23	13-25	15-27
	NC	-	-	-	11	16	21	25	28	31	37	41
09x06 .375	CFM	38	57	75	94	113	132	150	169	188	225	263
	Throws	1-6	3-9	4-12	5-15	6-17	7-18	8-19	9-20	10-21	12-23	14-25
	NC	-	-	-	-	15	20	24	28	31	36	41
09x09 .563	CFM	57	85	113	141	169	198	226	254	282	338	395
	Throws	1-7	3-11	5-14	6-18	7-20	8-22	10-23	11-25	12-26	14-29	17-31
	NC	-	-	-	12	17	22	26	29	32	38	42
10x06 .417	CFM	42	63	84	105	126	146	167	188	209	251	292
	Throws	1-6	3-9	4-12	5-15	6-17	7-19	8-20	9-21	10-22	12-25	14-27
	NC	-	-	-	-	16	21	24	28	31	37	41
10x08 .556	CFM	56	84	112	139	167	195	223	251	278	334	390
	Throws	1-7	3-11	5-14	6-18	7-20	8-22	9-23	11-25	12-26	14-28	17-31
	NC	-	-	-	12	17	22	26	29	32	38	42
10x10 .694	CFM	70	105	139	174	209	243	278	313	347	417	486
	Throws	1-8	3-12	5-16	7-20	8-22	9-24	11-26	12-27	13-29	16-32	19-34
	NC	-	-	-	13	18	23	27	30	33	39	43
12x06 .500	CFM	50	75	100	125	150	175	200	225	250	300	350
	Throws	1-7	3-10	5-14	6-17	7-19	8-21	9-22	10-21	11-25	14-27	16-29
	NC	-	-	-	11	17	21	25	29	32	37	42
12x08 .667	CFM	67	101	134	167	201	234	267	301	334	401	467
	Throws	1-8	3-12	5-16	7-20	8-22	9-24	10-25	12-27	13-28	16-31	18-34
	NC	-	-	-	12	18	23	26	30	33	39	43
12x10 .833	CFM	84	125	167	209	250	292	334	375	417	500	584
	Throws	2-9	4-13	6-17	7-12	9-25	10-27	12-28	13-30	15-32	17-35	20-38
	NC	-	-	-	13	19	23	27	31	34	40	44

CONTINUED

SERIES XG-SGRP PERFORMANCE DATA
MODEL XG-SGRP-SR-AL

Size (in)	Nk Vel	100	150	200	250	300	350	400	450	500	600	700
Neck Area ft ²	Ps	.002	.005	.009	.014	.020	.026	.035	.044	.054	.078	.106
12x12 1.000	CFM	100	150	200	250	300	350	400	450	500	600	700
	Throws	2-10	4-14	6-19	8-24	10-27	11-29	13-31	14-33	16-35	19-38	22-41
	NC	-	-	-	14	20	24	28	32	35	40	45
14x08 .778	CFM	78	117	156	195	234	273	312	351	389	467	545
	Throws	2-8	4-13	6-17	7-21	8-24	10-26	11-27	13-29	14-31	17-34	20-36
	NC	-	-	-	13	19	23	27	31	34	39	44
14x14 1.361	CFM	137	205	273	341	409	477	545	613	681	817	953
	Throws	2-11	5-17	7-22	9-28	11-31	13-34	15-36	17-39	19-41	22-44	27-49
	NC	-	-	-	15	21	26	30	33	36	42	46
15x15 1.563	CFM	157	235	313	391	469	548	626	704	782	938	1095
	Throws	2-12	5-18	8-24	10-30	12-34	14-36	16-39	18-41	20-44	24-48	28-51
	NC	-	-	-	16	22	26	30	34	37	42	47
16x10 1.111	CFM	112	167	223	278	334	389	445	500	556	667	778
	Throws	2-10	4-15	7-20	8-25	10-28	12-31	13-33	15-35	17-37	20-40	23-43
	NC	-	-	-	15	20	25	29	32	35	41	45
16x12 1.333	CFM	134	200	267	334	400	467	534	600	667	800	934
	Throws	2-11	5-17	7-22	9-28	11-31	13-34	15-36	17-38	18-40	22-44	26-48
	NC	-	-	-	15	21	25	29	33	36	42	46
16x16 1.778	CFM	178	267	356	445	534	623	712	801	889	1067	1245
	Throws	2-13	5-19	8-25	11-32	13-36	15-39	17-41	19-44	21-46	25-51	30-55
	NC	-	-	-	17	22	27	31	34	37	43	47

PERFORMANCE NOTES FOR SERIES XG-SGRP-SR-AL

All data is tested in accordance with ANSI/ASHRAE 70-2006.

DEFINITION OF UNITS

CFM Cubic Feet per Minute (air)

Nk Vel Neck Velocity is the airstream velocity in the duct just before it reaches the supply outlet; measured in Feet per Minute

NC Noise criterion, sound pressure level NC ratings are based on sound power level (Lw) re: 10⁻¹² watts minus a 10dB room attenuation in all octave bands

Throw Throw distance in feet are for terminal velocities of 50 and 100fpm respectively

Ps Static pressure = Pt-Pv (inches of water column)

SERIES XG-SGRP PERFORMANCE DATA
MODEL XG-SGRP-SR-AL

Size (in)	NK Vel	100	150	200	250	300	350	400	450	500	600	700
Neck Area ft ²	Ps	.002	.005	.009	.014	.020	.026	.035	.044	.054	.078	.106
18x12 1.500	CFM	150	225	300	375	450	525	600	675	750	900	1050
	Throws	2-12	5-18	8-23	10-29	12-33	14-36	16-38	18-40	19-43	23-47	27-50
	NC	-	-	-	16	21	26	30	33	37	42	47
18x18 2.250	CFM	225	338	450	563	675	788	900	1013	1125	1350	1575
	Throws	3-14	6-21	10-29	12-36	14-40	17-44	19-47	21-50	24-52	29-57	33-62
	NC	-	-	11	18	23	28	32	35	38	44	48
20x20 2.778	CFM	278	417	556	695	834	973	1112	1251	1389	1667	1945
	Throws	3-16	7-24	11-32	13-40	16-25	19-49	21-52	24-55	27-58	32-64	37-69
	NC	-	-	12	19	24	29	33	36	39	45	49
21x21 3.063	CFM	307	460	613	766	919	1073	1226	1379	1532	1838	2145
	Throws	3-17	7-25	11-33	14-42	17-47	19-51	22-54	25-58	28-61	33-67	39-72
	NC	-	-	12	19	24	29	33	37	40	45	50
22x22 3.361	CFM	337	505	673	841	1009	1177	1345	1513	1681	2017	2353
	Throws	3-17	7-26	12-35	15-44	18-49	20-53	23-57	26-61	29-64	35-70	41-75
	NC	-	-	13	19	25	29	33	37	40	46	50
24x06 1.000	CFM	100	150	200	250	300	350	400	450	500	600	700
	Throws	2-10	4-14	6-19	8-24	10-27	11-29	13-31	14-33	16-35	19-38	22-41
	NC	-	-	-	14	20	24	28	32	35	40	45
24x08 1.333	CFM	134	200	267	334	400	467	534	600	667	800	934
	Throws	2-11	5-17	7-22	9-28	11-31	13-34	15-36	17-38	18-40	22-44	26-48
	NC	-	-	-	15	21	25	29	33	36	42	46
24x12 2.000	CFM	200	300	400	500	600	700	800	900	1000	1200	1400
	Throws	3-14	6-20	9-27	11-34	14-38	16-41	18-44	20-47	23-49	27-54	32-58
	NC	-	-	-	17	23	27	31	35	38	43	48
24x18 3.000	CFM	300	450	600	750	900	1050	1200	1350	1500	1800	2100
	Throws	3-17	7-25	11-33	14-41	17-47	19-50	22-54	25-57	28-61	33-66	39-71
	NC	-	-	12	19	24	29	33	36	40	45	50
24x24 4.000	CFM	400	600	800	1000	1200	1400	1600	1800	2000	2400	2800
	Throws	4-19	8-29	13-38	16-48	19-54	22-58	25-62	29-66	32-70	38-76	45-82
	NC	-	-	14	20	26	30	34	38	41	46	51
26x26 4.694	CFM	470	705	939	1174	1409	1643	1878	2113	2347	2817	3286
	Throws	4-21	9-31	14-41	17-52	21-58	24-63	28-67	31-71	34-75	41-83	48-89
	NC	-	-	14	21	26	31	35	38	42	47	52

CONTINUED

SERIES XG-SGRP PERFORMANCE DATA
MODEL XG-SGRP-SR-AL

Size (in)	NK Vel	100	150	200	250	300	350	400	450	500	600	700
Neck Area ft ²	Ps	.002	.005	.009	.014	.020	.026	.035	.044	.054	.078	.106
30x12 2.500	CFM	250	375	500	625	750	875	1000	1125	1250	1500	1750
	Throws	3-15	6-23	10-30	13-38	15-43	18-46	20-49	23-52	25-55	30-60	35-65
	NC	-	-	11	18	24	28	32	36	39	44	49
30x24 5.000	CFM	500	750	1000	1250	1500	1750	2000	2250	2500	3000	3500
	Throws	4-21	9-32	14-43	18-53	21-60	25-65	28-70	32-74	36-78	43-85	50-92
	NC	-	-	14	21	27	31	35	39	42	47	52
30x30 6.250	CFM	625	938	1250	1563	1875	2188	2500	2813	3125	3750	4375
	Throws	4-24	10-36	16-48	20-60	24-67	28-73	32-78	36-83	40-87	48-95	56-103
	NC	-	-	15	22	28	32	36	40	43	48	53

PERFORMANCE NOTES FOR SERIES XG-SGRP-SR-AL

All data is tested in accordance with ANSI/ASHRAE 70-2006.

DEFINITION OF UNITS

CFM Cubic Feet per Minute (air)

Nk Vel Neck Velocity is the airstream velocity in the duct just before it reaches the supply outlet; measured in Feet per Minute

NC Noise criterion, sound pressure level NC ratings are based on sound power level (Lw) re: 10⁻¹² watts minus a 10dB room attenuation in all octave bands

Throw Throw distance in feet are for terminal velocities of 50 and 100fpm respectively

Ps Static pressure = Pt-Pv (inches of water column)

MODEL XG-SG2000

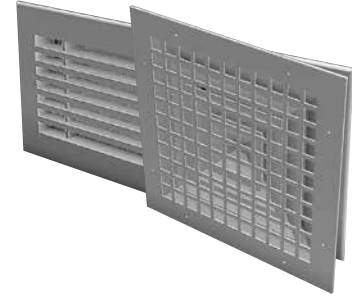

Minimum Security Grilles – Supply/Return/Exhaust Linear Bar Grille - Single Face/Series

XG-SG-2000 SG 2000 - 0° deflection

XG-SG 2015 - 15° deflection

XG-SG 2030 - 30° deflection

Air outlets (or inlets) shall be model XG-SG-2000-1 manufactured by GREENHECK. Units shall be minimum security supply grilles of aluminum construction.

Units shall have linear bars 3/4" deep by 7/32" wide spaced on 1/2" centers. Heavy extruded aluminum face and cross bars shall be arc welded aluminum frame. Border shall be 1" wide.

Optional: Unit shall include an 18 gauge, .galvanized steel wall sleeve fitted with an aluminum companion flange.

Accessories

Optional opposed blade damper shall be constructed of aluminum shall be provide on units 4" and wider. Units under 4" wide shall be provide with an aluminum "flap" type damper. Damper must be operable from the rear of the grille.

Performance Specification

The manufacturer shall provide published performance data. Data shall be tested in accordance to ANSI/ASHRAE Standard 70- 2006.

MODEL XG-SG2000

Minimum Security Grilles / Registers Extruded Aluminum - 1" Border - 7/32" Bars - 1/2" Center

Models: **XG-SG2000-1** **XG-SG2015-1** **XG-SG2030-1** Security Grille - 0°, 15° or 30° Deflection - No Sleeve
XG-SG2000-2 **XG-SG2015-2** **XG-SG2030-2** Security Grille - 0°, 15° or 30° Deflection - Steel Sleeve

Model: XG-2000-1 (Security Grille - 0°, 15° or 30° Deflection - With Steel Sleeve)

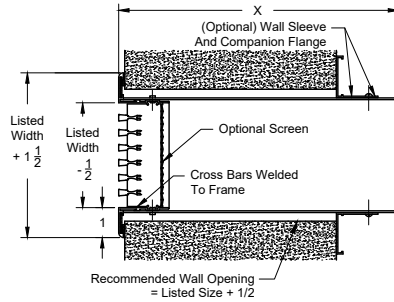

Face View (Both Models)
Mounting Screw Holes
Optional

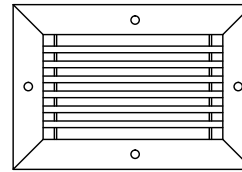

Model: XG-2000-2 (Security Grille - 0°, 15° or 30° Deflection - With Steel Sleeve)

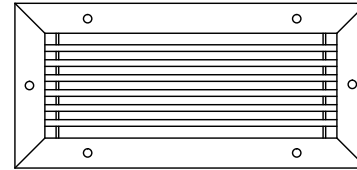
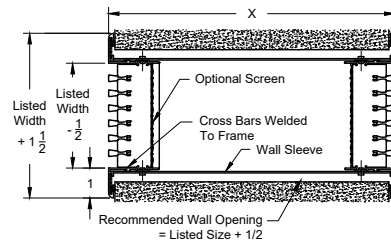

X - Has to be specify (when ordering).

Installation Option Only

XG-SG2000-1 / XG-SG2015-1 / XG-SG2030-1

XG-AAB	Aluminum Anchor Bars
XG-SBR-AL	Aluminum Security Bars
XG-LALA-2S	Loose Aluminum Angle (2 Angles A Short Dimension)
XG-LALA-2L	Loose Aluminum Angle (2 Angles Long Dimension)
XG-LALA-4	4 Loose Aluminum Angles
XG-WAF-AL	Welded Aluminum Angle Frame
XG-BALA-2S	Bolted Aluminum Angles (2 Angles Short Dimension)
XG-BALA-2L	Bolted Aluminum Angles (2 Angles Long Dimension)
XG-BALA-4	4 Bolted Aluminum Angles
XG-WALA-2S	Welded Aluminum Angles (2 Angles Short Dimension)
XG-WALA-2L	Welded Aluminum Angles (2 Angles Long Dimension)
XG-WALA-4	4 Welded Aluminum Angles

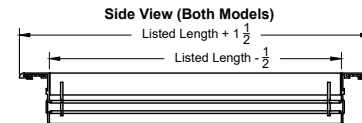

Air Pattern Deflectors

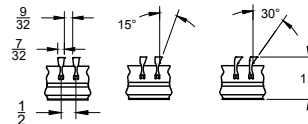

0° Deflection 15° Deflection 30° Deflection

XG-SG2000 MODEL NUMBER SPECIFICATION
MINIMUM SECURITY BAR GRILLES

Model	Neck																Sleeve
	6	8	10	12	14	16	18	20	22	24	26	28	30	32	34	36	
XG-SG2000-1																	
XG-SG2015-1	4	X	X	X	X	X	X	X	X	X	X	X	X	X	X	X	X
XG-SG2030-1	5	X	X	X	X	X	X	X	X	X	X	X	X	X	X	X	X
XG-SG2000-2	6	X	X	X	X	X	X	X	X	X	X	X	X	X	X	X	X
XG-SG2015-2	7		X	X	X	X	X	X	X	X	X	X	X	X	X	X	X
XG-SG2030-2	8		X	X	X	X	X	X	X	X	X	X	X	X	X	X	X
	10			X	X	X	X	X	X	X	X	X	X	X	X	X	X
	12				X	X	X	X	X	X	X	X	X	X	X	X	X

Available Finishes		Available Accessories - Aluminum	
Standard		XG-OBDA	Opposed Blade Damper
01	White	XG-AAB	Anchor Bars
Optional		XG-SBR-AL	Security Bars
02	Satin Silver	XG-LALA	Loose Angle
03	Black	XG-BALA	Bolted Angle
28	Custom Color	XG-WALA	Welded Angle
		XG-WAF-AL	Welded Angle Frame

XG-SG2000 PERFORMANCE DATA
MODEL XG-SG2000
XG-SG2000 (0° and 15° Deflection)

Listed Width (In Inches)	Free Area Per Foot (ft ²)	Outlet Velocity (Vk)	500	700	900	1000	1100	1200	1300
		Total Pressure (Pt)	.016	.031	.051	.062	.076	.090	.105
		Static Pressure (Ps)	.012	.024	.040	.050	.060	.072	.084
		NC	-	15	20	23	26	29	31
1 1/2"	.062	Flow CFM /FT	31	43	56	62	68	74	81
		Throw, Sill or Floor	6-9	9-13	10-14	11-16	13-18	13-19	14-20
		Throw, Side Wall	8-11	11-16	13-18	14-20	15-22	17-24	17-25
2"	.086	Flow CFM /FT	43	60	77	86	95	103	112
		Throw, Sill or Floor	5-8	8-12	10-14	11-16	13-18	13-19	14-20
		Throw, Side Wall	7-10	10-15	13-18	14-20	15-22	17-24	17-25
2 1/2"	.110	Flow CFM /FT	55	77	99	110	121	132	143
		Throw, Sill or Floor	6-9	9-13	11-16	13-18	13-19	15-21	15-22
		Throw, Side Wall	8-11	11-16	14-20	16-23	17-24	18-26	20-28
3"	.130	Flow CFM /FT	65	91	117	130	143	156	169
		Throw, Sill or Floor	7-10	10-15	13-18	15-21	15-22	17-24	18-26
		Throw, Side Wall	8-12	13-18	15-22	17-25	18-26	20-28	21-30
3 1/2"	.152	Flow CFM /FT	76	106	137	152	167	182	198
		Throw, Sill or Floor	7-10	10-15	13-18	15-21	15-22	17-24	18-26
		Throw, Side Wall	9-13	13-19	16-23	18-26	20-28	21-30	22-33
4"	.176	Flow CFM /FT	88	123	158	176	194	211	229
		Throw, Sill or Floor	8-11	12-16	14-20	16-23	18-26	19-27	20-29
		Throw, Side Wall	10-14	15-22	17-25	20-29	22-32	24-34	25-36
5"	.220	Flow CFM /FT	110	154	198	220	242	264	286
		Throw, Sill or Floor	8-12	13-18	15-21	17-24	18-26	19-27	21-30
		Throw, Side Wall	10-15	15-22	19-27	22-31	23-33	24-35	27-38
6"	.265	Flow CFM /FT	133	186	239	265	292	318	345
		Throw, Sill or Floor	8-12	13-18	15-22	17-25	18-26	20-28	21-30
		Throw, Side Wall	10-15	15-22	19-27	22-31	23-33	24-35	27-38
8"	.356	Flow CFM /FT	178	249	320	356	392		
		Throw, Sill or Floor	10-14	13-19	15-22	18-26	19-27		
		Throw, Side Wall	12-17	17-24	20-28	23-33	24-34		
10"	.446	Flow CFM /FT	223	312	401	446			
		Throw, Sill or Floor	10-15	15-22	18-26	21-30			
		Throw, Side Wall	13-19	20-28	23-33	26-37			

XG-SG2000 PERFORMANCE DATA
MODEL XG-SG2000

Listed Width (In Inches)	Outlet Velocity (Vk)	500	700	900	1000	1100	1200	1300
	Free Area Per Foot (ft ²)	Total Pressure (Pt)	.016	.031	.051	.062	.076	.090
Static Pressure (Ps)		.012	.024	.040	.050	.060	.072	.084
	NC	-	15	20	23	26	29	31
12"	Flow CFM /FT	268	375	482				
.536	Throw, Sill or Floor	12-17	22-31	21-33				
	Throw, Side Wall	15-21	24-35	27-38				

PERFORMANCE NOTES FOR SERIES XG-SG2000

All data is tested in accordance with ANSI/ASHRAE 70-2006.

DEFINITION OF UNITS

CFM Cubic Feet per Minute (air)

Nk Vel Neck Velocity is the airstream velocity in the duct just before it reaches the supply outlet; measured in Feet per Minute

NC Noise criterion, sound pressure level NC ratings are based on sound power level (Lw) re: 10⁻¹² watts minus a 10dB room attenuation in all octave bands

Throw Throw distance in feet are for terminal velocities of 150 and 50 fpm respectively / Supply Air temperature 20° F below room air temperature.

Pt Total pressures in inches of water column

Ps Static pressure = Pt-Pv (inches of water column)

**SG2000 PERFORMANCE DATA
MODEL XG-SG2000**
XG-SG2000 (30° Deflection)

Listed Width	Outlet Velocity (V _k)	500	700	900	1000	1100	1200	1300
(In Inches)	Total Pressure (Pt)	.020	.040	.067	.081	.100	.119	.139
Free Area Per Foot (ft ²)	Static Pressure (Ps)	.017	.034	.056	.070	.084	.100	.118
	NC	15	20	25	28	31	34	36
1 1/2"	Flow CFM /FT	35	49	64	71	78	84	92
	Throw, Sill or Floor	5-8	8-12	10-14	11-16	13-18	13-19	14-20
	Throw, Side Wall	7-9	10-14	12-16	14-20	15-22	17-24	17-25
2"	Flow CFM /FT	49	68	88	98	108	118	128
	Throw, Sill or Floor	6-9	9-13	10-14	11-16	13-18	13-19	14-20
	Throw, Side Wall	8-10	10-15	13-18	15-21	16-23	17-27	18-26
2 1/2"	Flow CFM /FT	63	88	113	126	138	151	163
	Throw, Sill or Floor	6-9	9-13	11-16	13-18	13-19	15-21	15-22
	Throw, Side Wall	8-11	11-16	14-20	16-23	17-24	18-26	20-28
3"	Flow CFM /FT	74	104	133	148	163	178	193
	Throw, Sill or Floor	7-10	10-14	13-18	15-21	15-22	17-24	18-26
	Throw, Side Wall	8-12	13-18	15-22	17-25	18-26	20-28	21-30
3 1/2"	Flow CFM /FT	87	121	156	173	191	208	226
	Throw, Sill or Floor	7-10	10-15	13-18	14-20	15-21	15-22	17-24
	Throw, Side Wall	9-13	13-19	16-23	18-26	20-28	21-30	22-32
4"	Flow CFM /FT	100	140	180	201	221	241	261
	Throw, Sill or Floor	8-11	13-18	15-21	17-24	18-26	19-27	21-30
	Throw, Side Wall	10-14	15-22	17-25	20-29	22-32	24-34	25-36
5"	Flow CFM /FT	126	176	226	251	276	301	326
	Throw, Sill or Floor	8-12	13-18	15-22	17-25	18-26	20-28	21-30
	Throw, Side Wall	10-15	15-22	19-27	22-31	23-33	24-35	27-38
6"	Flow CFM /FT	151	212	272	302	333	363	393
	Throw, Sill or Floor	9-13	13-18	15-22	17-25	18-26	20-28	21-30
	Throw, Side Wall	10-15	15-22	19-27	22-31	23-33	24-35	27-38
8"	Flow CFM /FT	203	284	366	406	447		
	Throw, Sill or Floor	10-14	13-19	15-22	18-26	19-27		
	Throw, Side Wall	12-17	17-24	20-28	23-33	24-34		

CONTINUED

XG-SG2000 PERFORMANCE DATA
MODEL XG-SG2000

Listed Width	Outlet Velocity (Vk)	500	700	900	1000	1100	1200	1300
(In Inches)	Total Pressure (Pt)	.020	.040	.067	.081	.100	.119	.139
Free Area Per Foot (ft ²)	Static Pressure (Ps)	.017	.034	.056	.070	.084	.100	.118
	NC	15	20	25	28	31	34	36
10" .446	Flow CFM /FT	254	356	458	509			
	Throw, Sill or Floor	10-15	15-22	18-26	21-30			
	Throw, Side Wall	13-19	20-28	23-33	26-37			
12" .536	Flow CFM /FT	306	428	550				
	Throw, Sill or Floor	12-17	22-31	21-30				
	Throw, Side Wall	15-21	24-35	27-38				

PERFORMANCE NOTES FOR SERIES XG-SG2000

All data is tested in accordance with ANSI/ASHRAE 70-2006.

DEFINITION OF UNITS

CFM Cubic Feet per Minute (air)

Nk Vel Neck Velocity is the airstream velocity in the duct just before it reaches the supply outlet; measured in Feet per Minute

NC Noise criterion, sound pressure level NC ratings are based on sound power level (Lw) re: 10⁻¹² watts minus a 10dB room attenuation in all octave bands

Throw Throw distance in feet are for terminal velocities of 150 and 50 fpm respectively / Supply Air temperature 20° F below room air temperature.

Pt Total pressures in inches of water column

Ps Static pressure = Pt-Pv (inches of water column)

MODEL XG-SGLF

Medium Security Grilles Lattice Face Steel

XG-SGLF-10 - 1" x 1" Lattice

XG-SGLF-13 - 13/16" x 13/16" Lattice

XG-SGLF-50 - 1/2" x 1/2" Lattice

XG-SGLF-75 - 3/4" x 3/4" Lattice

Air diffuser shall be model XG-SGLF/XG-SGLF-AL/XG-AGLF-SS manufactured by GREENHECK. Units shall be minimum security supply ceiling diffusers constructed of steel (SGLF), aluminum (SGLF-AL) or stainless steel (XG-SGLF-SS) Units shall consist of a 12-gauge steel lattice face panel with 13/16" square holes and 3/16" fret bars.

Units shall be attached to a 3/16" stitch welded sleeve.

Performance Specification

The manufacturer shall provide published performance data. Data shall be tested in accordance to ANSI/ ASHRAE Standard 70-2006.

Paint Specification

Process shall be anodic electro-deposition using an anodic acrylic paint. Units shall undergo pre-treatment including a pressurized spray stage using an alkaline cleaner and a de-ionized water rinse.

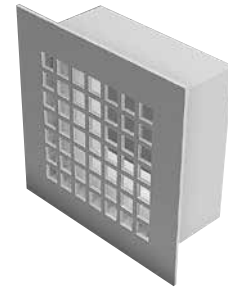

MODEL XG-SGLF

Security Grilles / Registers Steel

- Models: **XG-SGLF-10** Medium Security Grille - Lattice Face 1"x1"
 XG-SGLF-13 Medium Security Grille - Lattice Face 13/16"x13/16"
 XG-SGLF-50 Medium Security Grille - Lattice Face 1/2"x1/2"
 XG-SGLF-75 Medium Security Grille - Lattice Face 3/4"x3/4"

Model: XG-SGLF (Medium Security Grille - Lattice Face)

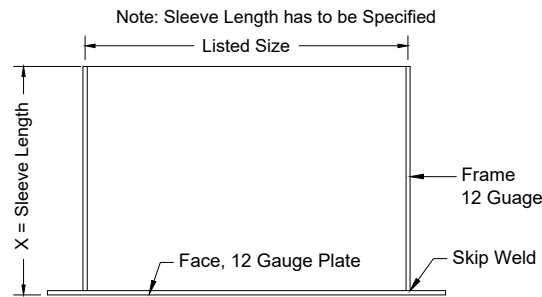

Face View (XG-SGLF Model)

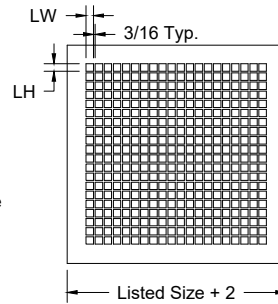

SGLF MODELS	
UNIT	SLOT SIZE LW x LH
SGLF-10	1"x1"
SGLF-13	13/16"x13/16"
SGLF-50	1/2"x1/2"
SGLF-75	3/4"x3/4"

XG-SAB



1/2 Diameter 3" Long For Concrete Block Or Brick Wall.

XG-SBR

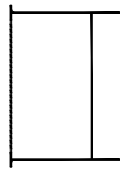

1/2 Diameter Bar On Maximum 6" Centers Welded To Sleeve

XG-LSA (showed XG-LSA-4)



4pcs. L1" x 1" x 3/16 2 Long; 2 Short Dimension Shipped loose for field welding

XG-BSA

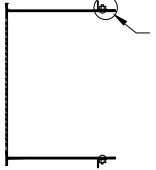

L1" x 1" x 3/16 Angles Bolted to Sleeve

XG-WSA

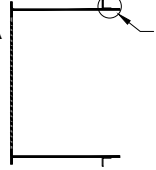

L1" x 1" x 3/16 Angles Welded to Sleeve

XG-WAF

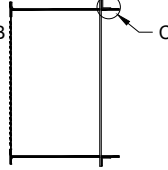

L1" x 1" x 3/16 Welded Angle Flange (Shipped Loose)

Mounting holes 1" from edge
Holes drilled where needed
Hardware provided by others
(nuts/bolts)



Detail A



Detail B



Detail C

XG-OB or XG-OBDA

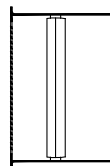

Rear Operated Opposed Blades

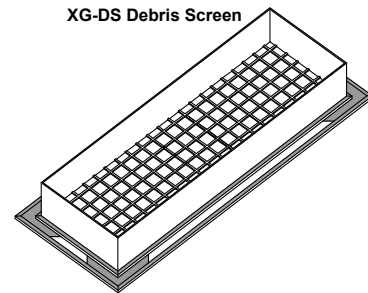

XG-DS Debris Screen

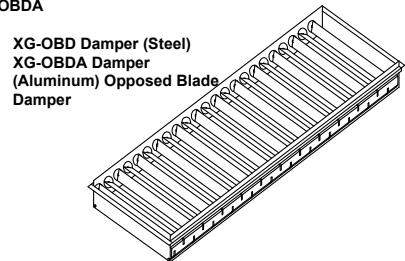

XG-OB Damper (Steel)
XG-OBDA Damper (Aluminum) Opposed Blade Damper

XG-SGLF MODEL NUMBER SPECIFICATION
MODELS XG-SGLF, XG-SGLF-AL, XG-SGLF-SS

Model	Neck												Sleeve
		28	30	32	34	36	38	40	42	44	46	48	
XG-SGLF													
XG-SGLF-AL	6	X	X	X	X	X	X	X	X	X	X	X	X
XG-SGLF-SS	8	X	X	X	X	X	X	X	X	X	X	X	X
	9	X	X	X	X	X	X	X	X	X	X	X	X
	10	X	X	X	X	X	X	X	X	X	X	X	X
	12	X	X	X	X	X	X	X	X	X	X	X	X
	14	X	X	X	X	X	X	X	X	X	X	X	X
	15	X	X	X	X	X	X	X	X	X	X	X	X
	16	X	X	X	X	X	X	X	X	X	X	X	X
	18	X	X	X	X	X	X	X	X	X	X	X	X
	20	X	X	X	X	X	X	X	X	X	X	X	X
	21	X	X	X	X	X	X	X	X	X	X	X	X
	22	X	X	X	X	X	X	X	X	X	X	X	X
	24	X	X	X	X	X	X	X	X	X	X	X	X
	26	X	X	X	X	X	X	X	X	X	X	X	X
	28	X	X	X	X	X	X	X	X	X	X	X	X
	30		X	X	X	X	X	X	X	X	X	X	X
	32			X	X	X	X	X	X	X	X	X	X
	34				X	X	X	X	X	X	X	X	X
	36					X	X	X	X	X	X	X	X
	38						X	X	X	X	X	X	X
	40							X	X	X	X	X	X
	42								X	X	X	X	X
	44									X	X	X	X
	46										X	X	X
	48											X	X

Available Finishes		Available Accessories - Steel		Available Accessories - Stainless Steel	
Steel - Standard		XG-OBD	Steel Opposed Blade Damper	XG-OBD-SS	Stainless Steel Opposed Blade Damper
01	White	XG-SAB	Steel Anchor Bars	XG-SAB-SS	Stainless Steel Anchor Bars
Steel - Optional		XG-SBR	Steel Security Bars	XG-SBR-SS	Stainless Steel Security Bars
02	Satin Silver	XG-LSA	Loose Steel Angle	XG-LSA-SS	Loose Stainless Steel Angle
03	Black	XG-BSA	Bolted Steel Angle	XG-BSA-SS	Bolted Stainless Steel Angle
28	Custom Color	XG-WSA	Welded Steel Angle	XG-WSA-SS	Welded Stainless Steel Angle
Stainless Steel - Standard		XG-WAF	Welded Steel Angle Frame	XG-WAF-SS	Welded Stainless Steel Angle Frame
23	Satin Polish	XG-SH	Optional Screw Holes In Face	XG-316-SS	316 Stainless Steel
Stainless Steel - Optional					
01	White Painted				
02	Satin Silver Painted				
03	Black Painted				
28	Custom Color				

SERIES XG-SGLF PERFORMANCE DATA
MODEL XG-SGLF

Size (in)	NK Vel	100	150	200	250	300	350	400	450	500	600	700
Neck Area ft ²	Ps	.002	.004	.008	.012	.018	.024	.032	.040	.049	.071	.096
06x06 .250	CFM	25	38	50	63	75	88	100	113	125	150	175
	Throws	1-5	2-7	3-10	4-12	5-13	6-15	6-16	7-17	8-17	10-19	11-21
	NC	-	-	-	-	11	15	19	23	26	31	36
08x06 .333	CFM	34	50	67	84	100	117	134	150	167	200	234
	Throws	1-5	2-8	4-11	5-14	6-16	6-17	7-18	8-19	9-20	11-22	13-24
	NC	-	-	-	-	12	16	20	24	27	33	37
08x08 .444	CFM	45	67	89	111	134	156	178	200	222	267	311
	Throws	1-6	3-9	4-13	5-16	6-18	7-19	8-21	10-22	11-23	13-25	15-27
	NC	-	-	-	-	13	18	22	25	26	34	38
09x06 .375	CFM	38	57	75	94	113	132	150	169	188	225	263
	Throws	1-6	3-9	4-12	5-15	6-17	7-18	8-19	9-20	10-21	12-23	14-25
	NC	-	-	-	-	12	17	21	25	28	33	38
09x09 .563	CFM	57	85	113	141	169	198	226	254	282	338	395
	Throws	1-7	3-11	5-14	6-18	7-20	8-22	10-23	11-25	12-26	14-29	17-31
	NC	-	-	-	-	14	19	23	26	29	35	39
10x06 .417	CFM	42	63	84	105	126	146	167	188	209	251	292
	Throws	1-6	3-9	4-12	5-15	6-17	7-19	8-20	9-21	10-22	12-25	14-27
	NC	-	-	-	-	13	18	21	25	28	34	38
10x08 .556	CFM	56	84	112	139	167	195	223	251	278	334	390
	Throws	1-7	3-11	5-14	6-18	7-20	8-22	9-23	11-25	12-26	14-28	17-31
	NC	-	-	-	-	14	19	23	26	29	35	39
10x10 .694	CFM	70	105	139	174	209	243	278	313	347	417	486
	Throws	1-8	3-12	5-16	7-20	8-22	9-24	11-26	12-27	13-29	16-32	19-34
	NC	-	-	-	-	15	20	24	27	30	36	40
12x06 .500	CFM	50	75	100	125	150	175	200	225	250	300	350
	Throws	1-7	3-10	5-14	6-17	7-19	8-21	9-22	10-21	11-25	14-27	16-29
	NC	-	-	-	-	14	18	22	26	29	34	39
12x08 .667	CFM	67	101	134	167	201	234	267	301	334	401	467
	Throws	1-8	3-12	5-16	7-20	8-22	9-24	10-25	12-27	13-28	16-31	18-34
	NC	-	-	-	-	15	20	23	27	30	36	40
12x10 .833	CFM	84	125	167	209	250	292	334	375	417	500	584
	Throws	2-9	4-13	6-17	7-12	9-25	10-27	12-28	13-30	15-32	17-35	20-38
	NC	-	-	-	-	16	20	24	28	31	37	41

CONTINUED

SERIES XG-SGLF PERFORMANCE DATA
MODEL XG-SGLF

Size (in)	NK Vel	100	150	200	250	300	350	400	450	500	600	700
Neck Area ft ²	Ps	.002	.004	.008	.012	.018	.024	.032	.040	.049	.071	.096
12x12 1.000	CFM	100	150	200	250	300	350	400	450	500	600	700
	Throws	2-10	4-14	6-19	8-24	10-27	11-29	13-31	14-33	16-35	19-38	22-41
	NC	-	-	-	11	17	21	25	29	32	37	42
14x08 .778	CFM	78	117	156	195	234	273	312	351	389	467	545
	Throws	2-8	4-13	6-17	7-21	8-24	10-26	11-27	13-29	14-31	17-34	20-36
	NC	-	-	-	-	16	20	24	28	31	36	41
14x14 1.361	CFM	137	205	273	341	409	477	545	613	681	817	953
	Throws	2-11	5-17	7-22	9-28	11-31	13-34	15-36	17-39	19-41	22-44	27-49
	NC	-	-	-	12	18	23	27	30	33	39	44
15x15 1.563	CFM	157	235	313	391	469	548	626	704	782	938	1095
	Throws	2-12	5-18	8-24	10-30	12-34	14-36	16-39	18-41	20-44	24-48	28-51
	NC	-	-	-	13	19	23	27	31	34	39	44
16x10 1.111	CFM	112	167	223	278	334	389	445	500	556	667	778
	Throws	2-10	4-15	7-20	8-25	10-28	12-31	13-33	15-35	17-37	20-40	23-43
	NC	-	-	-	12	17	22	26	29	32	38	42
16x12 1.333	CFM	134	200	267	334	400	467	534	600	667	800	934
	Throws	2-11	5-17	7-22	9-28	11-31	13-34	15-36	17-38	18-40	22-44	26-48
	NC	-	-	-	12	18	22	26	30	33	39	43
16x16 1.778	CFM	178	267	356	445	534	623	712	801	889	1067	1245
	Throws	2-13	5-19	8-25	11-32	13-36	15-39	17-41	19-44	21-46	25-51	30-55
	NC	-	-	-	14	19	24	28	31	34	40	44

PERFORMANCE NOTES FOR SERIES XG-SGLF

All data is tested in accordance with ANSI/ASHRAE 70-2006.

DEFINITION OF UNITS

CFM Cubic Feet per Minute (air)

Nk Vel Neck Velocity is the airstream velocity in the duct just before it reaches the supply outlet; measured in Feet per Minute

NC Noise criterion, sound pressure level NC ratings are based on sound power level (Lw) re: 10⁻¹² watts minus a 10dB room attenuation in all octave bands

Throw Throw distance in feet are for terminal velocities of 50 and 100fpm respectively

Ps Static pressure = Pt-Pv (inches of water column)

SERIES XG-SGLF PERFORMANCE DATA
MODEL XG-SGLF

Size (in)	NK Vel	100	150	200	250	300	350	400	450	500	600	700
Neck Area ft ²	Ps	.002	.004	.008	.012	.018	.024	.032	.040	.049	.071	.096
18x12 1.500	CFM	150	225	300	375	450	525	600	675	750	900	1050
	Throws	2-12	5-18	8-23	10-29	12-33	14-36	16-38	18-40	19-43	23-47	27-50
	NC	-	-	-	13	18	23	27	30	34	39	44
18x18 2.250	CFM	225	338	450	563	675	788	900	1013	1125	1350	1575
	Throws	3-14	6-21	10-29	12-36	14-40	17-44	19-47	21-50	24-52	29-57	33-62
	NC	-	-	-	15	20	25	29	32	35	41	45
20x20 2.778	CFM	278	417	556	695	834	973	1112	1251	1389	1667	1945
	Throws	3-16	7-24	11-32	13-40	16-25	19-49	21-52	24-55	27-58	32-64	37-69
	NC	-	-	-	16	21	26	30	33	36	42	46
21x21 3.063	CFM	307	460	613	766	919	1073	1226	1379	1532	1838	2145
	Throws	3-17	7-25	11-33	14-42	17-47	19-51	22-54	25-58	28-61	33-67	39-72
	NC	-	-	-	16	21	26	30	34	37	42	47
22x22 3.361	CFM	337	505	673	841	1009	1177	1345	1513	1681	2017	2353
	Throws	3-17	7-26	12-35	15-44	18-49	20-53	23-57	26-61	29-64	35-70	41-75
	NC	-	-	-	16	22	26	30	34	37	43	47
24x06 1.000	CFM	100	150	200	250	300	350	400	450	500	600	700
	Throws	2-10	4-14	6-19	8-24	10-27	11-29	13-31	14-33	16-35	19-38	22-41
	NC	-	-	-	11	17	21	25	29	32	37	42
24x08 1.333	CFM	134	200	267	334	400	467	534	600	667	800	934
	Throws	2-11	5-17	7-22	9-28	11-31	13-34	15-36	17-38	18-40	22-44	26-48
	NC	-	-	-	12	18	22	26	30	33	39	43
24x12 2.000	CFM	200	300	400	500	600	700	800	900	1000	1200	1400
	Throws	3-14	6-20	9-27	11-34	14-38	16-41	18-44	20-47	23-49	27-54	32-58
	NC	-	-	-	14	20	24	28	32	35	40	45
24x18 3.000	CFM	300	450	600	750	900	1050	1200	1350	1500	1800	2100
	Throws	3-17	7-25	11-33	14-41	17-47	19-50	22-54	25-57	28-61	33-66	39-71
	NC	-	-	-	16	21	26	30	33	37	42	47
24x24 4.000	CFM	400	600	800	1000	1200	1400	1600	1800	2000	2400	2800
	Throws	4-19	8-29	13-38	16-48	19-54	22-58	25-62	29-66	32-70	38-76	45-82
	NC	-	-	11	17	23	27	31	35	39	43	48

CONTINUED

SERIES XG-SGLF PERFORMANCE DATA
MODEL XG-SGLF

Size (in)	NK Vel	100	150	200	250	300	350	400	450	500	600	700
Neck Area ft ²	Ps	.002	.004	.008	.012	.018	.024	.032	.040	.049	.071	.096
26x26 4.694	CFM	470	705	939	1174	1409	1643	1878	2113	2347	2817	3286
	Throws	4-21	9-31	14-41	17-52	21-58	24-63	28-67	31-71	34-75	41-83	48-89
	NC	-	-	11	18	23	28	32	35	39	44	49
30x12 2.500	CFM	250	375	500	625	750	875	1000	1125	1250	1500	1750
	Throws	3-15	6-23	10-30	13-38	15-43	18-46	20-49	23-52	25-55	30-60	35-65
	NC	-	-	-	15	21	25	29	33	36	41	46
30x24 5.000	CFM	500	750	1000	1250	1500	1750	2000	2250	2500	3000	3500
	Throws	4-21	9-32	14-43	18-53	21-60	25-65	28-70	32-74	36-78	43-85	50-92
	NC	-	-	11	18	24	28	32	36	39	44	49
30x30 6.250	CFM	625	938	1250	1563	1875	2188	2500	2813	3125	3750	4375
	Throws	4-24	10-36	16-48	20-60	24-67	28-73	32-78	36-83	40-87	48-95	56-103
	NC	-	-	12	19	25	29	33	37	40	45	50

PERFORMANCE NOTES FOR SERIES XG-SGLF

All data is tested in accordance with ANSI/ASHRAE 70-2006.

DEFINITION OF UNITS

CFM Cubic Feet per Minute (air)

Nk Vel Neck Velocity is the airstream velocity in the duct just before it reaches the supply outlet; measured in Feet per Minute

NC Noise criterion, sound pressure level NC ratings are based on sound power level (Lw) re: 10⁻¹² watts minus a 10dB room attenuation in all octave bands

Throw Throw distance in feet are for terminal velocities of 50 and 100fpm respectively

Ps Static pressure = Pt-Pv (inches of water column)

MODEL XG-SGDB

Maximum Security Barrier Grilles Steel – XG-SGDB Duct Barrier Bars

XG-SGDB - Steel duct bars, in sleeve

sXG-SGDB-SS - Stainless steel duct bars, in sleeve

XG-SGDF - Steel duct bars in 2" frame

XG-SGDF-SS - Stainless steel duct bars in 2" frame

XG-SGDFF - Steel duct bars in flanged frame

XG-SGDFF-SS - Stainless steel duct bars in flanged frame



Barrier grille shall be model XG-SGDB manufactured by GREENHECK. Units shall be barrier grilles constructed with 1/2" diameter bars on 6" center mounted in a 3/16" steel sleeve. Units to include two angle frames 1"x 1" x 3/16", one welded and one shipped loose.

The units shall be the size and quantity as outlined in the plans and specifications.

Performance Specification

The manufacturer shall provide published performance data. Data shall be tested in accordance to ANSI/ ASHRAE Standard 70-2006.

Paint Specification

Process shall be anodic electro-deposition using an anodic acrylic paint. Units shall undergo pre-treatment including a pressurized spray stage using an alkaline cleaner and a de-ionized water rinse.

MODEL XG-SGDB

Maximum Security Barrier Grilles Steel

Models: **XG-SGDB** Duct Bars Welded in Sleeve - 4-12" or 13-16" Sleeve Size

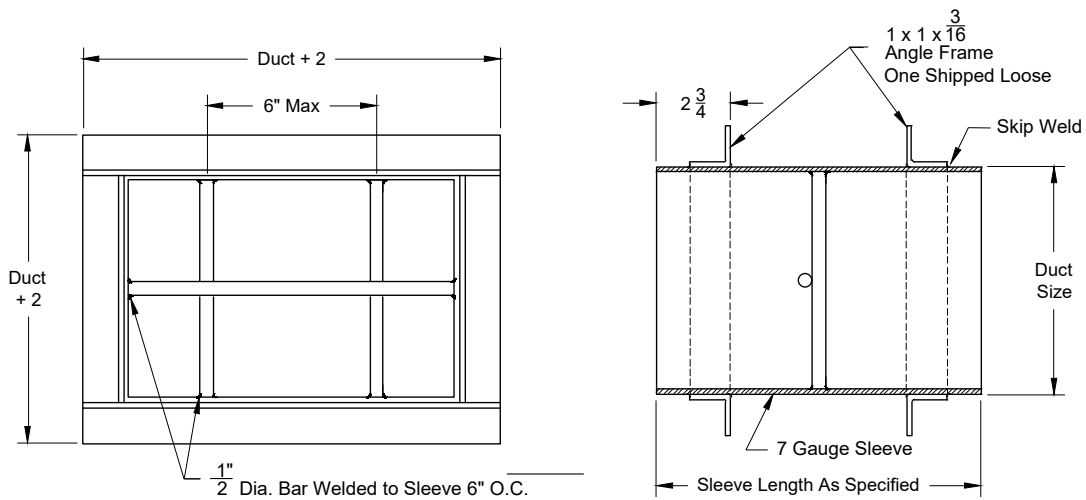

XG-SAB

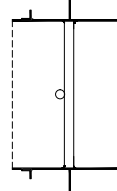

Steel Anchor Bars
1/2" Diameter 3" Long
for Concrete Block
or Brick Wall.

XG-BSA

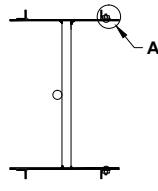

Bolted Steel Angles
BSA-2S - 2 Angles Short Dimension
BSA-2L - 2 Angles Long Dimension
BSA-4 - 4 Angles, L1" x 1" x 3/16"
Angle mounting holes punched
1" from each end of the angle
for field installation
Customer to use the angle mounting
holes to mark up and drill sleeves as
necessary
Hardware supplied by others. (nuts &
bolts)

Options

XG-WSA

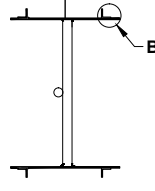

Welded Steel Angles
WSA-2S - 2 Angles Short Dimension
WSA-2L - 2 Angles Long Dimension
WSA-4 - 4 Angles, L1" x 1" x 3/16"
Shipped Welded To Sleeve

XG-WAF

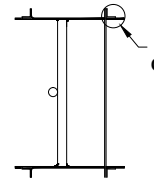

4 Angles, L1" x 1" x 3/16"
Welded Steel Angle Flange
(Shipped Loose)



Detail A



Detail B



Detail C

XG-SGDB MODEL NUMBER SPECIFICATION

MODELS XG-SGDB, XG-SDDB-SS, XG-SGDF, XG-SGDF-SS, XG-SGDF, XG-SGDF-SS, XG-SGDF, XG-SGDF-SS

Model		Neck												Sleeve	
		6	8	9	10	12	14	15	16	18	20	21	22		24
XG-SGDB	6	X	X	X	X	X	X	X	X	X	X	X	X	X	4 - 16
XG-SDDB-SS	8		X	X	X	X	X	X	X	X	X	X	X	X	
XG-SGDF	9			X	X	X	X	X	X	X	X	X	X	X	
XG-SGDF-SS	10				X	X	X	X	X	X	X	X	X	X	
SXG-GDF	12					X	X	X	X	X	X	X	X	X	
XG-SGDF-SS	14						X	X	X	X	X	X	X	X	
	15							X	X	X	X	X	X	X	
	16								X	X	X	X	X	X	
	18									X	X	X	X	X	
	20										X	X	X	X	
	21											X	X	X	
	22												X	X	
	24													X	

Available Finishes	
Standard	
01	White
Optional	
02	Satin Silver
03	Black
28	Custom Color

XG-SGDB MODEL NUMBER SPECIFICATION
MODELS XG-SGDB, XG-SDDB-SS, XG-SGDF, XG-SGDF-SS, XG-SGDF, XG-SGDF-SS

Model	Neck													Sleeve
	26	28	30	32	34	36	38	40	42	44	46	48		
XG-SGDB	6	X	X	X	X	X	X	X	X	X	X	X	X	4 - 16
XG-SDDB-SS	8	X	X	X	X	X	X	X	X	X	X	X	X	
XG-SGDF	9	X	X	X	X	X	X	X	X	X	X	X	X	
XG-SGDF-SS	10	X	X	X	X	X	X	X	X	X	X	X	X	
XG-SGDF	12	X	X	X	X	X	X	X	X	X	X	X	X	
XG-SGDF-SS	14	X	X	X	X	X	X	X	X	X	X	X	X	
	15	X	X	X	X	X	X	X	X	X	X	X	X	
	16	X	X	X	X	X	X	X	X	X	X	X	X	
	18	X	X	X	X	X	X	X	X	X	X	X	X	
	20	X	X	X	X	X	X	X	X	X	X	X	X	
	21	X	X	X	X	X	X	X	X	X	X	X	X	
	22	X	X	X	X	X	X	X	X	X	X	X	X	
	24	X	X	X	X	X	X	X	X	X	X	X	X	
	26	X	X	X	X	X	X	X	X	X	X	X	X	
	28		X	X	X	X	X	X	X	X	X	X	X	
	30			X	X	X	X	X	X	X	X	X	X	
	32				X	X	X	X	X	X	X	X	X	
	34					X	X	X	X	X	X	X	X	
	36						X	X	X	X	X	X	X	
	38							X	X	X	X	X	X	
	40								X	X	X	X	X	
	42									X	X	X	X	
	44										X	X	X	
	46											X	X	
	48												X	

Available Finishes	
Standard	
01	White
Optional	
02	Satin Silver
03	Black
28	Custom Color

MODEL XG-SGDF

The XG-SGDF barrier grille is designed for openings between secure and non-secured areas that are restricted. The XG-SGDF is mounted in a flat frame and is available in steel (XG-SGDF) or stainless steel (XG-SGDF-SS) construction.

- Bars are 1/2" round on maximum 6" centers
- Mounting frame is 10-gauge steel and 2" wide

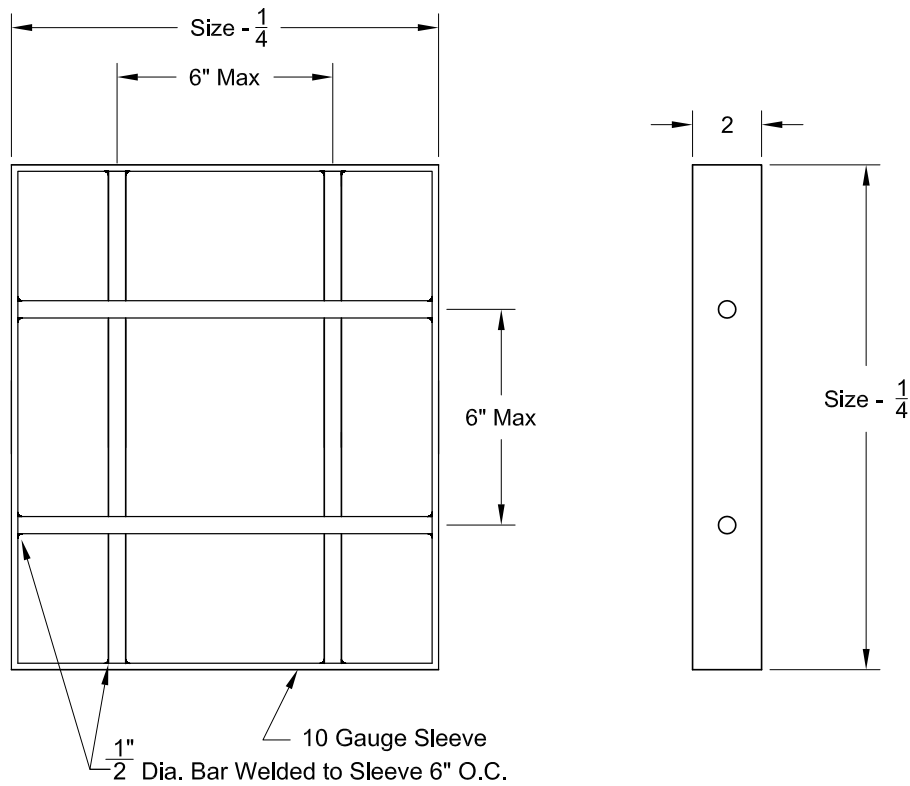
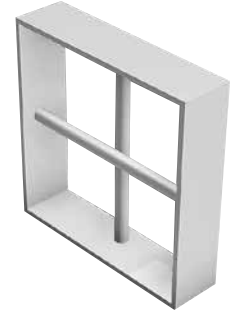

XG-SGDF MODEL NUMBER SPECIFICATION
MODELS XG-SGDB, XG-SDDB-SS, XG-SGDF, XG-SGDF-SS, XG-SGDFF, XG-SGDFF-SS

Model	Neck														Sleeve
	6	8	9	10	12	14	15	16	18	20	21	22	24		
XG-SGDB	X	X	X	X	X	X	X	X	X	X	X	X	X	X	4 - 16
XG-SDDB-SS		X	X	X	X	X	X	X	X	X	X	X	X	X	
XG-SGDF			X	X	X	X	X	X	X	X	X	X	X	X	
XG-SGDF-SS				X	X	X	X	X	X	X	X	X	X	X	
XG-SGDFF					X	X	X	X	X	X	X	X	X	X	
XG-SGDFF-SS						X	X	X	X	X	X	X	X	X	
							X	X	X	X	X	X	X	X	
								X	X	X	X	X	X	X	
									X	X	X	X	X	X	
										X	X	X	X	X	
											X	X	X	X	
												X	X	X	
													X	X	
														X	

Available Finishes	
Standard	
01	White
Optional	
02	Satin Silver
03	Black
28	Custom Color

XG-SGDF MODEL NUMBER SPECIFICATION

MODELS XG-SGDB, XG-Sddb-SS, XG-SGDF, XG-SGDF-SS, XG-SGDF, XG-SGDF-SS

Model	Neck													Sleeve
	26	28	30	32	34	36	38	40	42	44	46	48		
XG-SGDB	6	X	X	X	X	X	X	X	X	X	X	X	X	4 - 16
XG-Sddb-SS	8	X	X	X	X	X	X	X	X	X	X	X	X	
XG-SGDF	9	X	X	X	X	X	X	X	X	X	X	X	X	
XG-SGDF-SS	10	X	X	X	X	X	X	X	X	X	X	X	X	
XG-SGDF	12	X	X	X	X	X	X	X	X	X	X	X	X	
XG-SGDF-SS	14	X	X	X	X	X	X	X	X	X	X	X	X	
	15	X	X	X	X	X	X	X	X	X	X	X	X	
	16	X	X	X	X	X	X	X	X	X	X	X	X	
	18	X	X	X	X	X	X	X	X	X	X	X	X	
	20	X	X	X	X	X	X	X	X	X	X	X	X	
	21	X	X	X	X	X	X	X	X	X	X	X	X	
	22	X	X	X	X	X	X	X	X	X	X	X	X	
	24	X	X	X	X	X	X	X	X	X	X	X	X	
	26	X	X	X	X	X	X	X	X	X	X	X	X	
	28		X	X	X	X	X	X	X	X	X	X	X	
	30			X	X	X	X	X	X	X	X	X	X	
	32				X	X	X	X	X	X	X	X	X	
	34					X	X	X	X	X	X	X	X	
	36						X	X	X	X	X	X	X	
	38							X	X	X	X	X	X	
	40								X	X	X	X	X	
	42									X	X	X	X	
	44										X	X	X	
	46											X	X	
	48												X	

Available Finishes	
Standard	
01	White
Optional	
02	Satin Silver
03	Black
28	Custom Color

MODEL XG-SGDFF



The XG-SGDFF barrier grille is designed for openings between secure and non-secured areas. The XG-SGDFF is mounted in a flanged frame and is available in steel (XG-SGDFF) or stainless steel (XG-SGDFF-SS) construction.

- Bars are 1/2" round on maximum 6" centers
- Flange frame is 10-gauge steel and 2" wide

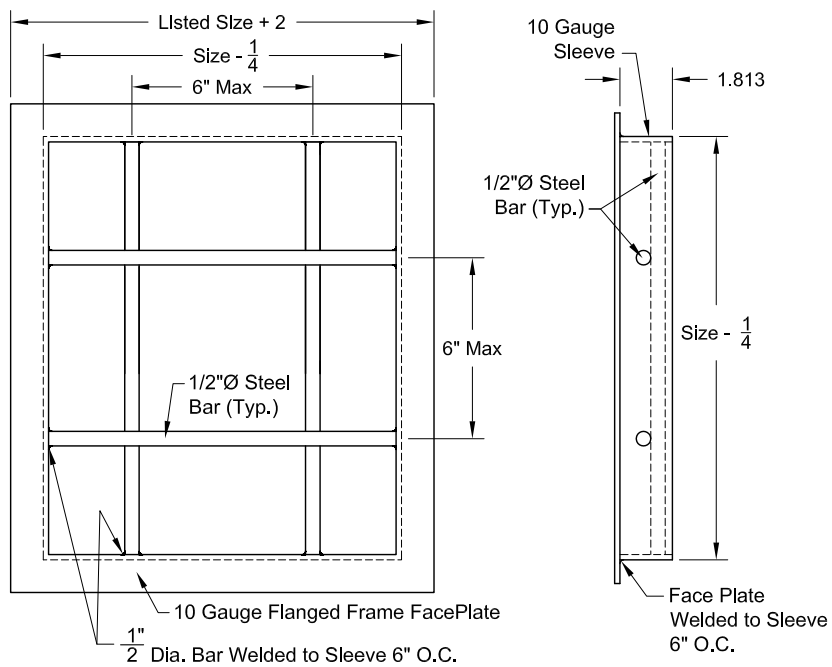

XG-SDGFF MODEL NUMBER SPECIFICATION

MODELS XG-SGDB, XG-SDDB-SS, XG-SGDF, XG-SGDF-SS, XG-SGDFF, XG-SGDFF-SS

Model		Neck												Sleeve	
		6	8	9	10	12	14	15	16	18	20	21	22		24
XG-SGDB	6	X	X	X	X	X	X	X	X	X	X	X	X	X	4 - 16
XG-SDDB-SS	8		X	X	X	X	X	X	X	X	X	X	X	X	
XG-SGDF	9			X	X	X	X	X	X	X	X	X	X	X	
XG-SGDF-SS	10				X	X	X	X	X	X	X	X	X	X	
XG-SGDFF	12					X	X	X	X	X	X	X	X	X	
XG-SGDFF-SS	14						X	X	X	X	X	X	X	X	
	15							X	X	X	X	X	X	X	
	16								X	X	X	X	X	X	
	18									X	X	X	X	X	
	20										X	X	X	X	
	21											X	X	X	
	22												X	X	
	24													X	

Available Finishes	
Standard	
01	White
Optional	
02	Satin Silver
03	Black
28	Custom Color

XG-SGDF MODEL NUMBER SPECIFICATION
MODELS XG-SGDB, XG-SDDB-SS, XG-SGDF, XG-SGDF-SS, XG-SGDF, XG-SGDF-SS, XG-SGDF, XG-SGDF-SS

Model		Neck												Sleeve
		26	28	30	32	34	36	38	40	42	44	46	48	
XG-SGDB	6	X	X	X	X	X	X	X	X	X	X	X	X	4 - 16
XG-SDDB-SS	8	X	X	X	X	X	X	X	X	X	X	X	X	
XG-SGDF	9	X	X	X	X	X	X	X	X	X	X	X	X	
XG-SGDF-SS	10	X	X	X	X	X	X	X	X	X	X	X	X	
XG-SGDF	12	X	X	X	X	X	X	X	X	X	X	X	X	
XG-SGDF-SS	14	X	X	X	X	X	X	X	X	X	X	X	X	
	15	X	X	X	X	X	X	X	X	X	X	X	X	
	16	X	X	X	X	X	X	X	X	X	X	X	X	
	18	X	X	X	X	X	X	X	X	X	X	X	X	
	20	X	X	X	X	X	X	X	X	X	X	X	X	
	21	X	X	X	X	X	X	X	X	X	X	X	X	
	22	X	X	X	X	X	X	X	X	X	X	X	X	
	24	X	X	X	X	X	X	X	X	X	X	X	X	
	26	X	X	X	X	X	X	X	X	X	X	X	X	
	28		X	X	X	X	X	X	X	X	X	X	X	
	30			X	X	X	X	X	X	X	X	X	X	
	32				X	X	X	X	X	X	X	X	X	
	34					X	X	X	X	X	X	X	X	
	36						X	X	X	X	X	X	X	
	38							X	X	X	X	X	X	
	40								X	X	X	X	X	
	42									X	X	X	X	
	44										X	X	X	
	46											X	X	
	48												X	

Available Finishes	
Standard	
01	White
Optional	
02	Satin Silver
03	Black
28	Custom Color

SECURITY GRILLE FACE PLATES ONLY AND ACCESSORIES

MODEL XG-SGLFO

Steel Lattice / Perforated Grille Face Only

- Models: **XG-SGLFO-13** Steel Lattice Grille Face Only
 XG-SGLFO-50 Steel Lattice Grille Face Only
 XG-SGLFO-75 Steel Lattice Grille Face Only
 XG-SGLFO-10 Steel Lattice Grille Face Only

XG-SGLFO Face View

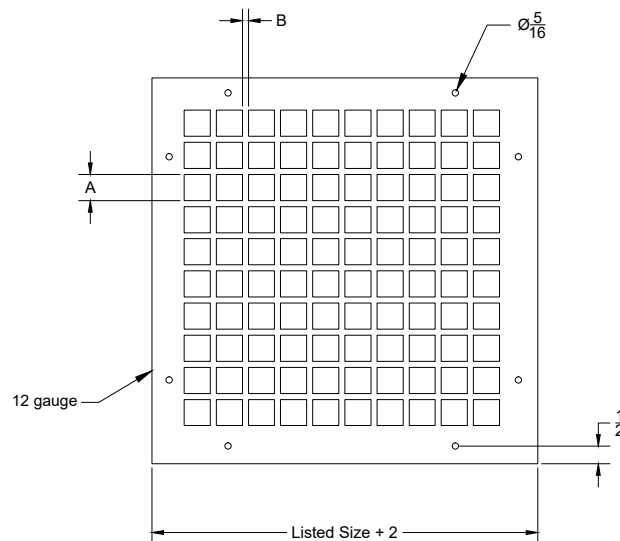

PERFORATION SIZES		
UNIT	A (SQ)	B
XG-SGLFO-13	13/16	3/16
XG-SGLFO-50	1/2	3/16
XG-SGLFO-75	3/4	3/16
XG-SGLFO-10	1	3/16

MODEL XG-SGLFO-AL

Aluminum Lattice / Perforated Grille Face Only

Models: XG-SGLFO-AL-13 Aluminum Lattice Grille Face Only
 XG-SGLFO-AL-50 Aluminum Lattice Grille Face Only
 XG-SGLFO-AL-75 Aluminum Lattice Grille Face Only
 XG-SGLFO-AL-10 Aluminum Lattice Grille Face Only

XG-SGLFO-AL Face View

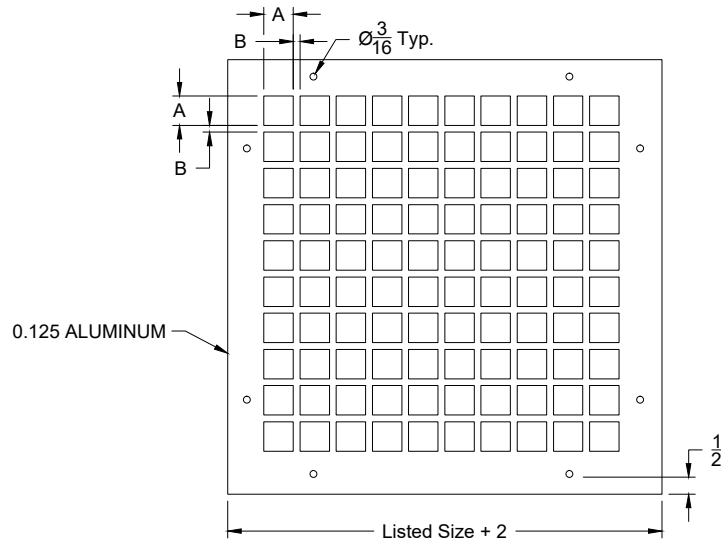

PERFORATION SIZES		
UNIT	A (SQ)	B
XG-SGLFO-AL-13	13/16	3/16
XG-SGLFO-AL-50	1/2	3/16
XG-SGLFO-AL-75	3/4	3/16
XG-SGLFO-AL-10	1	3/16

MODEL XG-SGLFO-SS

Stainless Steel Lattice / Perforated Grille Face Only

- Models: XG-SGLFO-SS-13 Stainless Steel Lattice Grille Face Only
 XG-SGLFO-SS-50 Stainless Steel Lattice Grille Face Only
 XG-SGLFO-SS-75 Stainless Steel Lattice Grille Face Only
 XG-SGLFO-SS-10 Stainless Steel Lattice Grille Face Only

XG-SGLFO-SS Face View

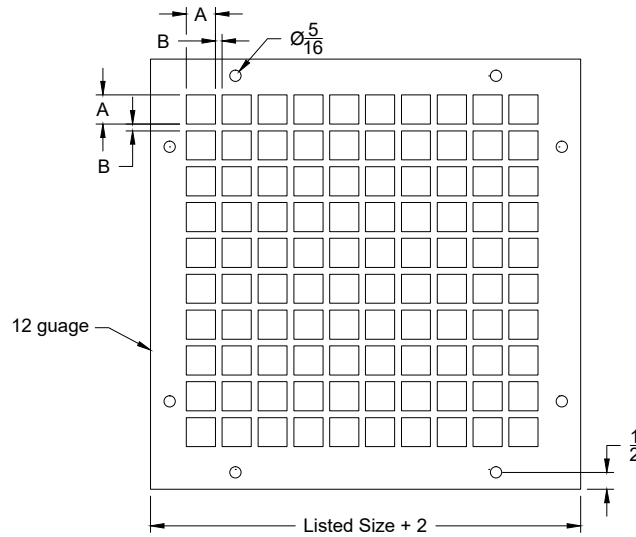

PERFORATION SIZES		
UNIT	A (SQ)	B
XG-SGLFO-SS-13	13/16	3/16
XG-SGLFO-SS-50	1/2	3/16
XG-SGLFO-SS-75	3/4	3/16
XG-SGLFO-SS-10	1	3/16

GRILLES AND REGISTERS ACCESSORIES



XG-L9
Square / Rectangular Equalizing Grid

PAGE 286



XG-OBDA
Aluminum Opposed Blade Damper

PAGE 286



XG-OBD
Steel Opposed Blade Damper

PAGE 286

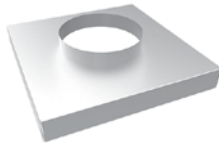

XG-TR
Square to Round Transition

PAGE 286

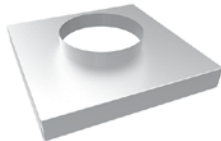

XG-TR Deep
Deep Square to Round Transitions

PAGE 286



XG-PF
Plaster Frame

PAGE 287

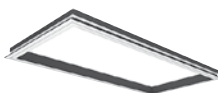

XG-TBPF
T-bar Plaster Frames permit installation

PAGE 287

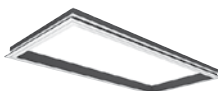

XG-LIPF
Lay-in Plaster Frame

PAGE 287

MODEL XG-L9

Model XG-L9 – Square/Rectangular Equalizing Grid

- Designed to provide uniform airflow in branch ducts
- Pre-tensioned blades adjust individually
- Aluminum construction

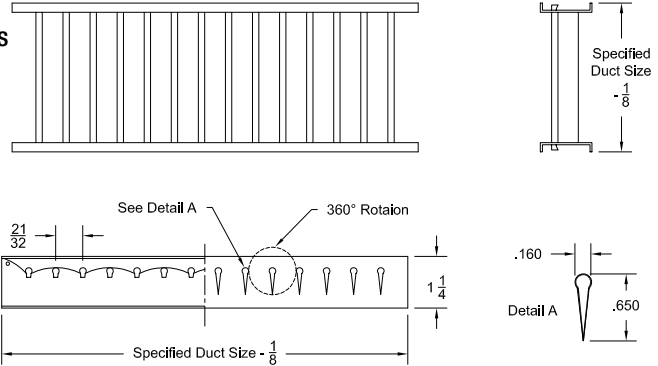

MODEL XG-OBDA/XG-OBD

Model XG-OBDA/XG-OBD square/rectangular opposed blade damper

- Tapered blades set in a U-channel frame
- Opposed blades on 1" centers
- Screwdriver slot operator
- Aluminum construction, XG-OBDA
- Steel construction, XG-OBD

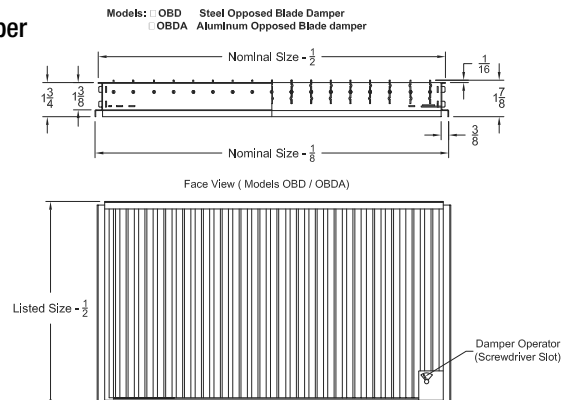

MODEL XG-TR/XG-TR DEEP

Model XG-TR/XG-TR Deep Square to Round Transitions

- Available for all ducted supply and return diffusers
- Provide economical means of adapting square neck diffusers to round neck connections
- XG-TR Deep transitions provide additional depth to accommodate some dampers

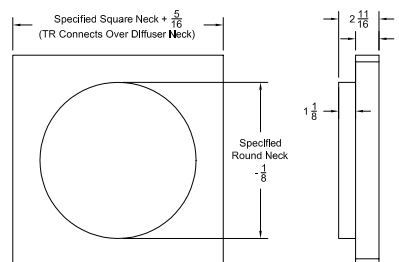

Available Size	
Square Neck Size	Round Neck Size
6 x 6	4, 5 & 6
8 x 8	5, 6, 7 & 8
9 x 9	5, 6, 7, 8 & 9
10 x 10	5, 6, 7, 8, 9 & 10
12 x 12	5, 6, 7, 8, 9, 10, 11 & 12
14 x 14	5, 6, 7, 8, 9, 10, 11, 12 & 14
15 x 15	5, 6, 7, 8, 9, 10, 11, 12, 14 & 15
16 x 16	5, 6, 7, 8, 9, 10, 11, 12, 14, 15 & 16
18 x 18	5, 6, 7, 8, 9, 10, 11, 12, 14, 15, 16 & 18
22 x 22	5, 6, 7, 8, 9, 10, 11, 12, 14, 15, 16, 18, 20 & 22

MODEL XG-PF

Model: XG-PF (Extruded Aluminum - Side wall Mounted Plaster Frame)

Model XG-PF sidewall mounted plaster frame provides a uniform opening in sidewall to accommodate grilles and registers

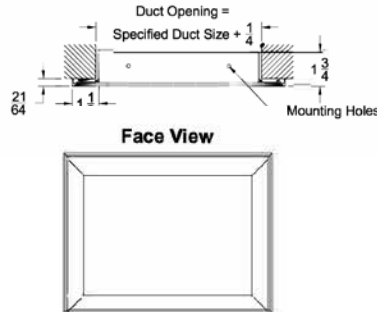

MODEL XG-TBPF

Model XG-TBPF T-bar Plaster Frames permit installation of T-bar frame style ceiling diffusers into plaster frame or gypsum ceilings, and are available in standard T-bar sizes.

- Converts T-bar frame to Surface Mount
- Available in aluminum, XG-TBPF, or steel, XG-STBPF, construction

Available Sizes (XG-TBPF & XG-STBPF Models)	
Nominal	Overall
12 x 12	13 3/16 x 13 3/16
24 x 12	25 3/16 x 13 3/16
24 x 24	25 3/16 x 25 3/16
36 x 24	37 3/16 x 25 3/16
36 x 36	37 3/16 x 37 3/16
48 x 24	49 3/16 x 25 3/16
48 x 48	49 3/16 x 49 3/16
13 x 13	14 3/16 x 14 3/16

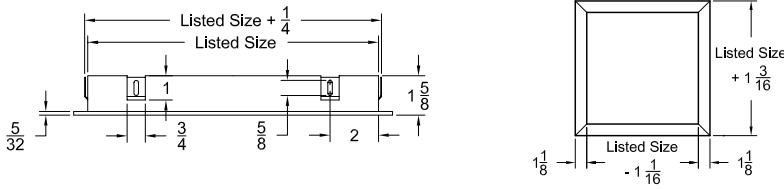

MODEL XG-LIPF

Model XG-LIPF permits installation of a grille or register into a plaster or gypsum ceiling type.

LIPF Lay-In Aluminum Plaster Frame (Used with -1 Units)
 SLIPF Lay-In Steel Plaster Frame (Used with -1 Units)

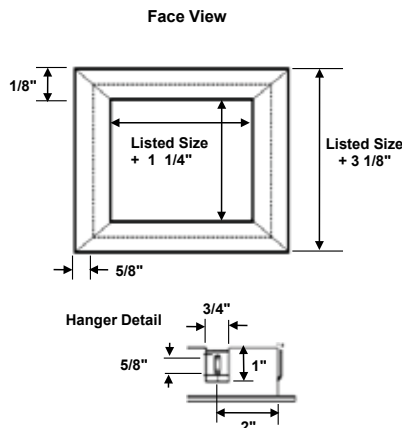
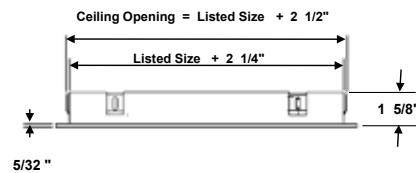

XG-LIPF / XG-SLIPF Model List			
XG-4002-1	XG-42F-1	XG-CC5XG-S1	XG-RPF-1
XG-4002R-1	XG-4500-1	XG-L Series	XG-SRH-1
XG-4002RXG-S1	XG-4538-1	XG-RH-1	XG-SRHF-1
XG-4002XG-S1	XG-CC1-1	XG-RHE-1	XG-SRP-1
XG-4004-1	XG-CC15-1	XG-RHEF-1	XG-SRPF-1
XG-4004XG-S1	XG-CC5-1	XG-RHF-1	XG-V Series
XG-41F-1	XG-CC5F-1	XG-RP-1	

Design and Selection Support

Enjoy Greenheck's extraordinary service, before, during and after the sale.

Greenheck offers added value to our wide selection of top performing, energy-efficient products by providing several unique service programs.



Our Quick Delivery program ensures shipment of in-stock products within 24 hours of placing your order. Our Quick Build made-to-order products are manufactured in 1-3-5-10-15 or 25-day production cycles, depending upon its complexity.



Greenheck's free computer aided product selection program CAPS®, rated by many as the best in the industry, helps you conveniently and efficiently select the right products for the challenge at hand.



Our 3D service allows you to download, at no charge, easy-to-use AutoDesk® Revit® 3D drawings for many of our ventilation products.

Find out more about these special services at greenheck.com

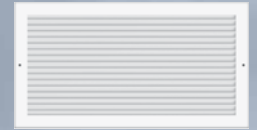

Building Value in Air

Greenheck delivers value to mechanical engineers by helping them solve virtually any air quality challenges their clients face with a comprehensive selection of

top quality, innovative air-related equipment. We offer extra value to contractors by providing easy-to-install, competitively priced, reliable products that arrive on time.

And building owners and occupants value the energy efficiency, low maintenance and quiet dependable operation they experience long after the construction project ends.

Our Commitment

As a result of our commitment to continuous improvement, Greenheck reserves the right to change specifications without notice.

Specific Greenheck product warranties are located on greenheck.com within the product area tabs and in the Library under Warranties.

