

Model: XG-CC15-1      Cubed Core 1/2"x1/2"x1" - Flush Surface Mount  
 XG-CC15-6      Cubed Core 1/2"x1/2"x1" - T-Bar Lay-In

### XG-CC15-1 - Flush Surface Mount

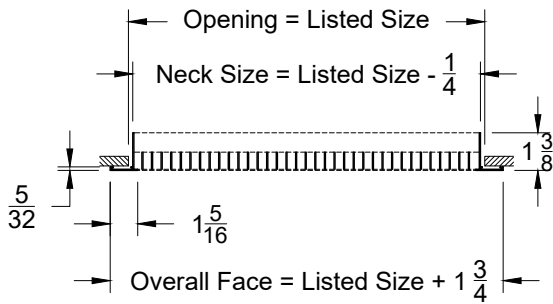

### Face View

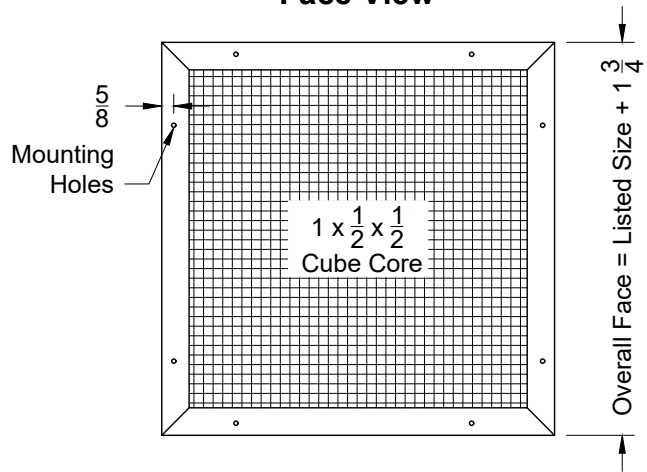

### XG-CC15-6 - T-Bar Lay-In

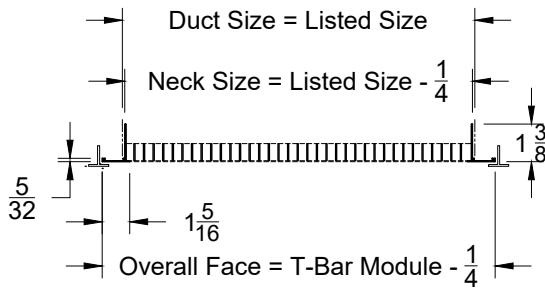

### Face View

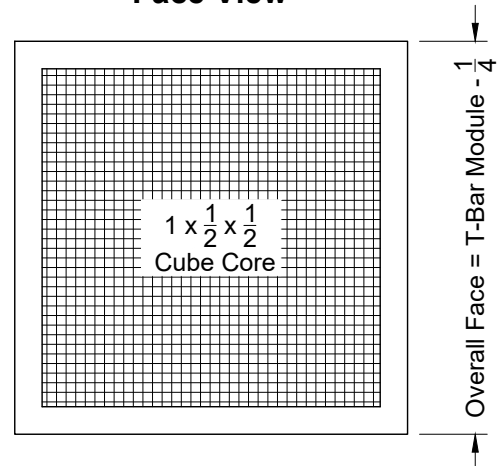

Note: This product complies with NFPA 90A-18 standard 4.3.7.3.2 and 4.3.8.3.2 and is constructed with openings through which a 1/2" sphere can not pass.

1. Available Finishes	2. Available Accessories	3. Available Options	4. Construction Details
Standard Finish: 01 White Finish 24 Mill Finish Optional Finish 02 Satin Silver 03 Black 28 Custom Color	XG-OBD - Steel Opposed Blade Damper XG-OBDA - Aluminum OBD XG-L9 - Equalizing Grid XG-PF - Plaster Frame XG-TBPF - T-Bar Plaster Frame XG-TR - Square to Round Transition XG-TR-Deep - Deep Transition XG-LIPF - Lay-In Plaster Frame	IS - Insect Screen FGBP - Fiberglass Backpan NSH - No Screw Holes CM - Concealed Mount	<ul style="list-style-type: none"> <li>● Odd/Fractional Sizes Available for additional charge</li> <li>● Oversized Units made in multiple sections</li> <li>● Largest single section is 48x48</li> <li>● Mullion strips provided for joining units in field</li> <li>● Available in MRI-compatible aluminum construction</li> </ul>

All Dimensions  $\pm 1/16"$

Model: XG-CC15-8      Cubed Core 1/2"x1/2"x1" - Tegular Module  
 XG-CC15-9      Cubed Core 1/2"x1/2"x1" - Bolt Slot / Donn Finline Module

### XG-CC15-8 - Tegular Module

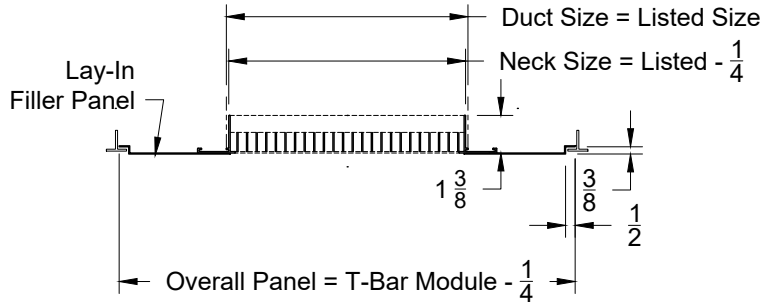

### Face View

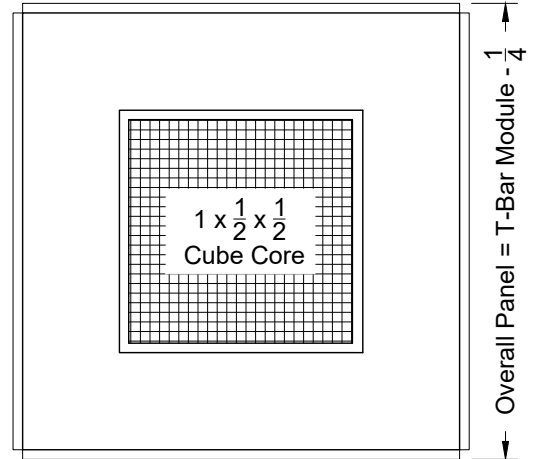

### XG-CC15-9 - Bolt Slot / Donn Finline Module

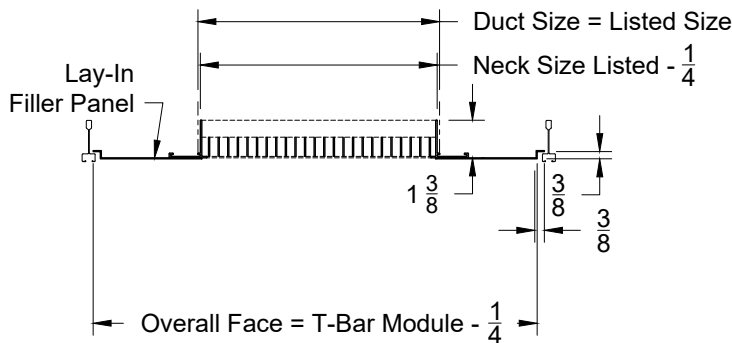

### Face View

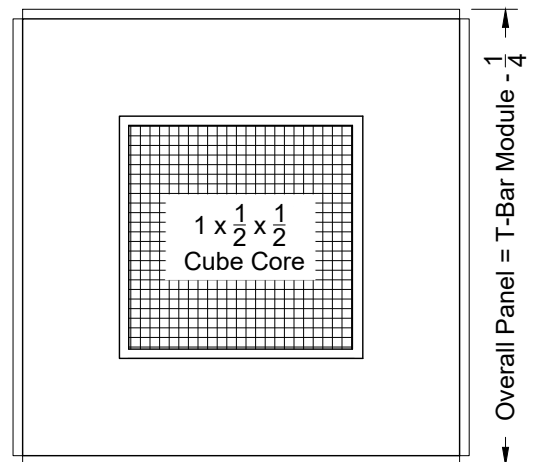

Note: This product complies with NFPA 90A-18 standard 4.3.7.3.2 and 4.3.8.3.2 and is constructed with openings through which a 1/2" sphere can not pass.

1. Available Finishes	2. Available Accessories	3. Available Options	4. Construction Details
Standard Finish: 01 White Finish 24 Mill Finish Optional Finish 02 Satin Silver 03 Black 28 Custom Color	XG-OBDA - Steel Opposed Blade Damper XG-OBDA - Aluminum OBD XG-L9 - Equalizing Grid XG-PF - Plaster Frame XG-TBPF - T-Bar Plaster Frame XG-TR - Square to Round Transition XG-TR-Deep - Deep Transition XG-LIPF - Lay-In Plaster Frame	IS - Insect Screen FGBP - Fiberglass Backpan NSH - No Screw Holes CM - Concealed Mount	<ul style="list-style-type: none"> <li>• Odd/Fractional Sizes Available for additional charge</li> <li>• Oversized Units made in multiple sections</li> <li>• Largest single section is 48x48</li> <li>• Mullion strips provided for joining units in field</li> <li>• Available in MRI-compatible aluminum construction</li> </ul>

All Dimensions  $\pm 1/16"$