

XG-FCQ-700 ULTRA QUIET FAN TERMINAL UNIT

SPECIFIABLE FEATURES

- Rigid construction to mitigate vibration
- Minimal clearance NEMA TYPE 1 rated control enclosure
- Units can be rotated in the field for left / right hand installation
- Single speed high efficiency PSC motor with SCR motor speed control
- Energy saving case design allows for less seams for very low leakage
- Tuned inlet and outlet attenuators
- The quietest box available

INDEX OF SECTIONS

	PAGE
Dimensional Data	4
Shipping Weights / Filter Sizes / Certifications & Standards	8
AHRI Certified Rating Points	9
Sound Performance Data	10
Motor Data / Damper Leakage	12
Optional Electronic Anti-Reverse Rotation Device	13
Hot Water Coils	14
Electric Heat	16
Control Sequence Offerings	18
Fan Performance Curves	19

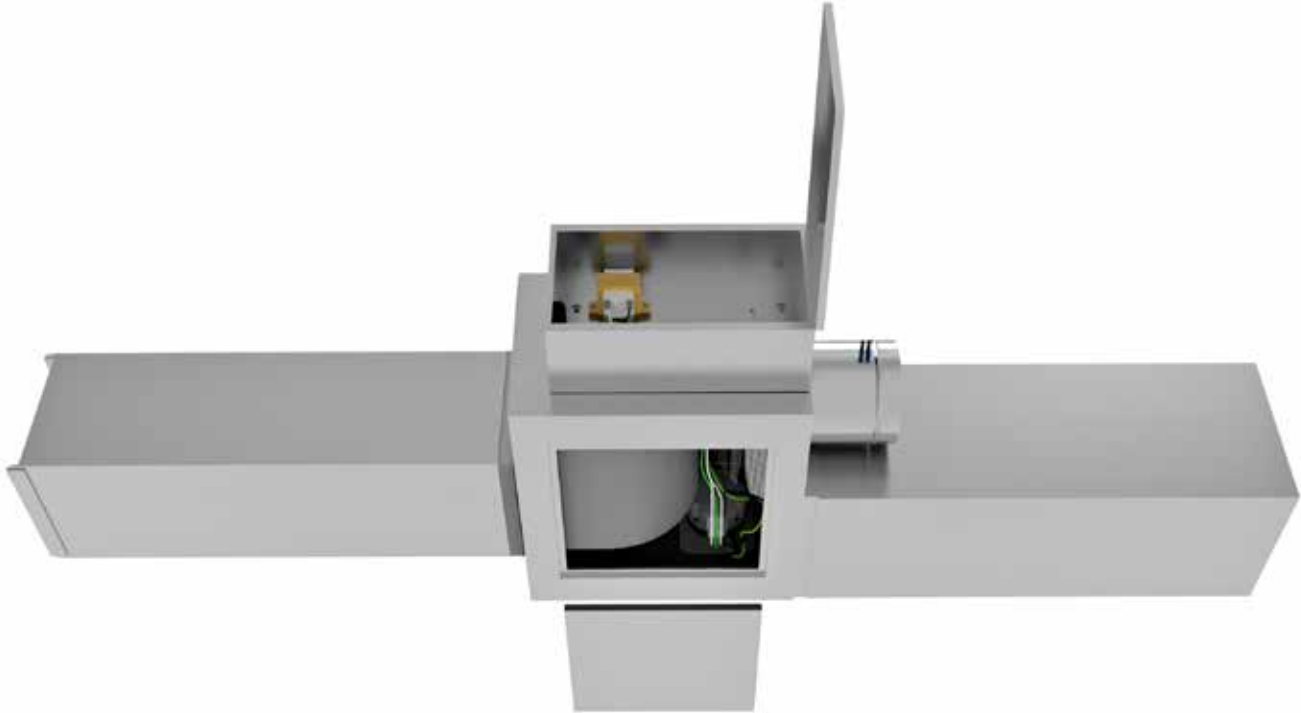

XG-FCQ-700 ULTRA QUIET SERIES FAN TERMINAL UNIT

The new XG-FCQ quiet series fan-powered ATU has been engineered to provide noise levels that are the best in the business. All six models of the XG-FCQ product line include exclusively tuned inlet and outlet attenuators. The XG-FCQ includes an internal flow-dispersion screen designed specifically to provide low-frequency acoustic conversion. The XG-FCQ attenuators add to the overall length, not width, providing easier installation and access.

The XG-FCQ is constructed from rigid galvanized steel designed to mitigate vibration and increase rigidity. The unique Energy Saving 4-piece case construction allows fewer seams for low leakage. Every XG-FCQ includes top and bottom rigid access panels. This feature allows units to be rotated, eliminating left-hand/right-hand (LH/RH) issues in the field. These simple-to-remove panels use quarter-turn latches to allow trouble-free maintenance and access to the critical internal components.

XG-FCQ units include 1" thick, matte-faced fiberglass insulation that complies with UL 181 horizontal burn test, NFPA 90 and UL 723/ASTM E 84 flame spread and smoke developed ratings of 25/50. Optional insulations include metal-foil-faced and fiber- and erosion-free ThermoPure (closed-cell foam).

High efficiency single phase, single speed permanent split capacitor (PSC) motors are standard in the XG-FCQ product line. Available voltages of 120, 277, and 208-240 volts (50/60 Hz) allows for every possible situation, and all motors come with a solid state SCR motor speed controller to adjust fan speed.

Optional electronically commutated motors (ECM) are available to increase energy savings further. Up to 75% energy savings is typical with the ECM option.

No detail was overlooked. A new optional control panel was developed for the XG-FCQ to allow critical component access with minimal clearance. This unique control panel utilizes a sliding door with integral backstop. Simply slide it open for maintenance or access.

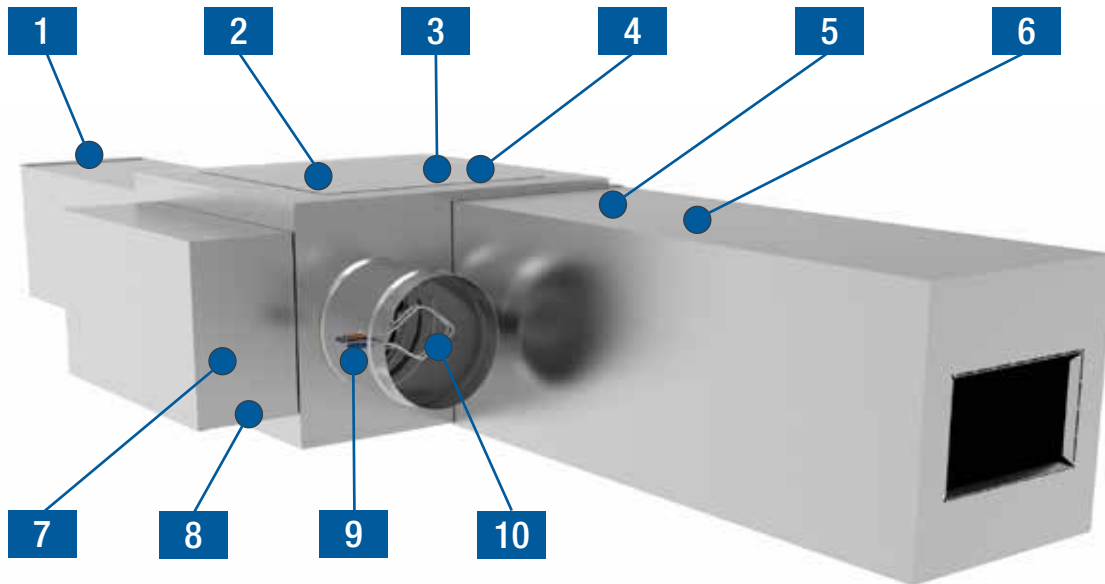

XG-FCQ-700 ULTRA QUIET SERIES FAN TERMINAL UNIT

FEATURES AND BENEFITS

- 1** Energy saving case design allows fewer seams for very low leakage.
- 2** Single speed high efficiency PSC motor with SCR motor speed control.
- 3** Top and bottom motor / blower access panels with ¼ turn fasteners for easy removal and installation.
- 4** 1" thick matt faced fiberglass insulation that complies with UL 181, NFPA 90 and UL7 23 / ASTM E 84. Capped to prevent delaminating.
- 5** Unit can be rotated in field for left hand or right hand installation.
- 6** Unit includes exclusively tuned inlet and discharge attenuators.
- 7** Minimal clearance NEMA TYPE 1 rated control enclosure.
- 8** Constructed with galvanized steel casing to help mitigate vibration.
- 9** Continuous welded galvanized steel primary inlet valve for leak proof and rigid design.
- 10** Multi point quadrant averaging all metal inlet flow sensor capable of maintaining $\pm 5\%$ accuracy with varying inlet duct conditions.

XG-FCQ-700 ULTRA QUIET SERIES FAN POWERED AIR TERMINAL UNIT COOLING ONLY

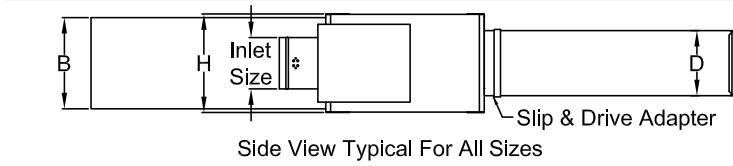

The standard location for control enclosure is Left Hand Looking in the direction of airflow, the control enclosure is on the left.

The Discharge Silencer is centered on H and W dimensions

*Inlet Duct extends 12" on sizes 4 & 5

Top & Bottom Mounted Access Enclosures Allow Unit To Be Hung LH or RH

The Induction and Discharge Silencers are shipped loose. A Slip & Drive Adapter(s) is provided and mounted for field connection of the Discharge Silencer(s).

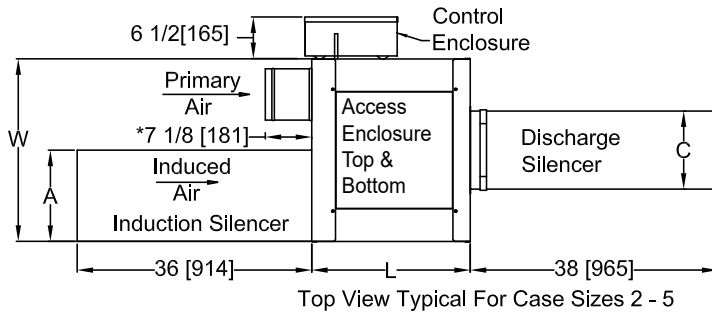

Optional ECM Motor available on Case sizes 2,3,4&6

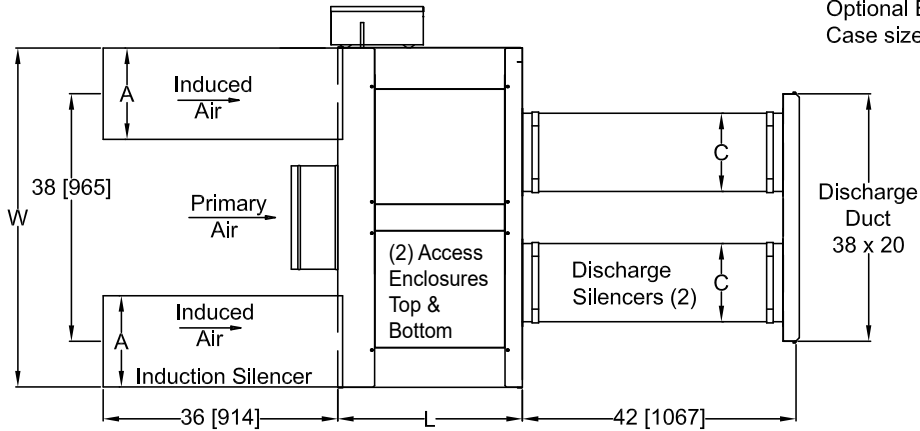

Case size	Inlet Size		Horsepower		Unit Dimensions			Induction Silencer		Discharge Silencer	
	Standard	Optional	Standard PSC	ECM	Height H	Width W	Length L	Width A	Height B	Width C	Height D
2	8 (203)	4,5,6	1/8	1/3	15	25	24	14	14	12	10
3	10 (254)	4,5,6,8	1/4	1/2	18	29	28	16	18	14	12 1/2
4	12 (305)	6,8,10	1/3	1	18	32 1/2	28	18	18	16	15
5	12 (305)	8,10	1/3	NA	18	32 1/2	28	18	18	16	15
6	16 (406)	10,12,14	1/3(2)	1/2(2)	18	52	30	16	18	16	15
7	18x16 (457x406)	12,14,16	3/4(2)	NA	20	52	30	16	20	16	15

XG-FCQ-700 ULTRA QUIET SERIES FAN POWERED AIR TERMINAL UNIT WITH HOT WATER COIL

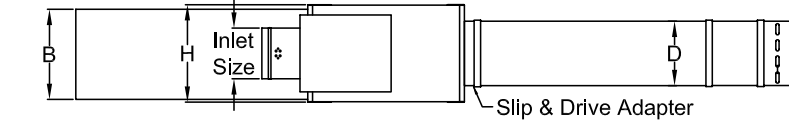

The standard location for control enclosure is Left Hand
 Looking in the direction of airflow, the control enclosure is on the left.

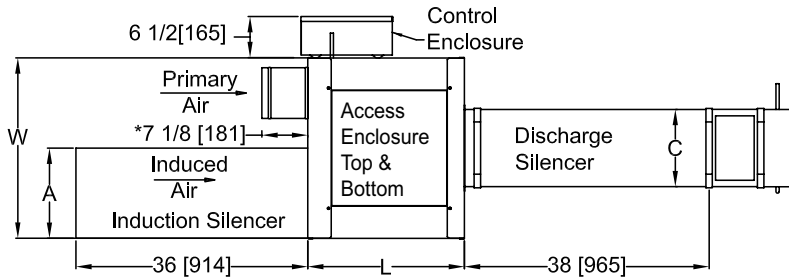

The Discharge Silencer is centered on H and W dimensions

*Inlet Duct extends 12" on sizes 4&5

Top & Bottom Mounted Access Enclosures Allow Unit To Be Hung LH or RH

The Induction and Discharge Silencers are shipped loose. A Slip & Drive Adapter(s) is provided and mounted for field connection of the Discharge Silencer(s).

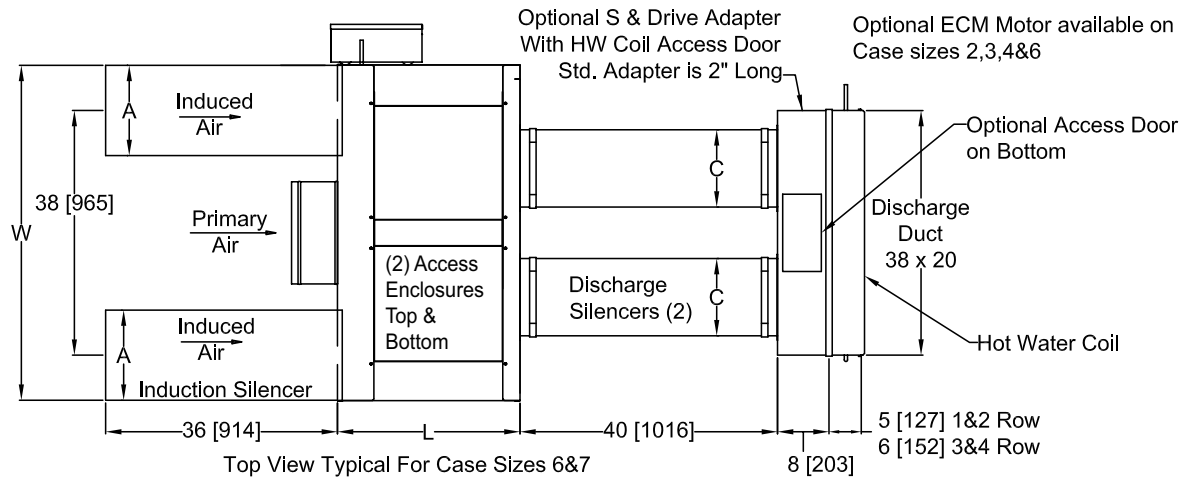

Optional S & Drive Adapter With HW Coil Access Door
 Std. Adapter is 2" Long

Optional ECM Motor available on Case sizes 2,3,4&6

Optional Access Door on Bottom

Discharge Duct 38 x 20

Hot Water Coil

Case size	Inlet Size		Horsepower		Unit Dimensions			Induction Silencer		Discharge Silencer	
	Standard	Optional	Standard PSC	ECM	Height H	Width W	Length L	Width A	Height B	Width C	Height D
2	8 (203)	4,5,6	1/8	1/3	15	25	24	14	14	12	10
3	10 (254)	4,5,6,8	1/4	1/2	18	29	28	16	18	14	12 1/2
4	12 (305)	6,8,10	1/3	1	18	32 1/2	28	18	18	16	15
5	12 (305)	8,10	1/3	NA	18	32 1/2	28	18	18	16	15
6	16 (406)	10,12,14	1/3(2)	1/2(2)	18	52	30	16	18	16	15
7	18x16 (457x406)	12,14,16	3/4(2)	NA	20	52	30	16	20	16	15

XG-FCQ-700 ULTRA QUIET SERIES FAN POWERED AIR TERMINAL UNIT WITH ELECTRIC HEAT

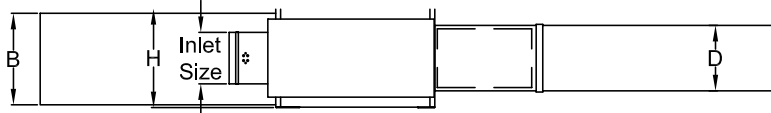

Side View Typical For All Sizes

The standard location for control panel is Left Hand
Looking in the direction of airflow, the control panel is on the left.

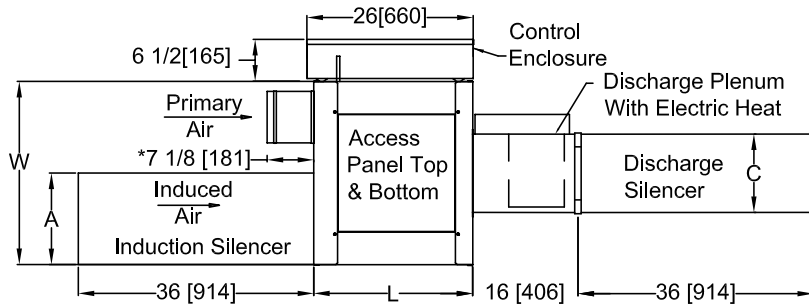

Top View Typical For Case Sizes 2 - 5

The Discharge Silencer is centered on H and W dimensions

*Inlet Duct is 12" on sizes 4&5

Top & Bottom Mounted Access Panels Allow Unit To Be Hung LH or RH

The Induction and Discharge Silencers are shipped loose. A Slip & Drive Adapter(s) is provided and mounted for field connection of the Discharge Silencer(s).

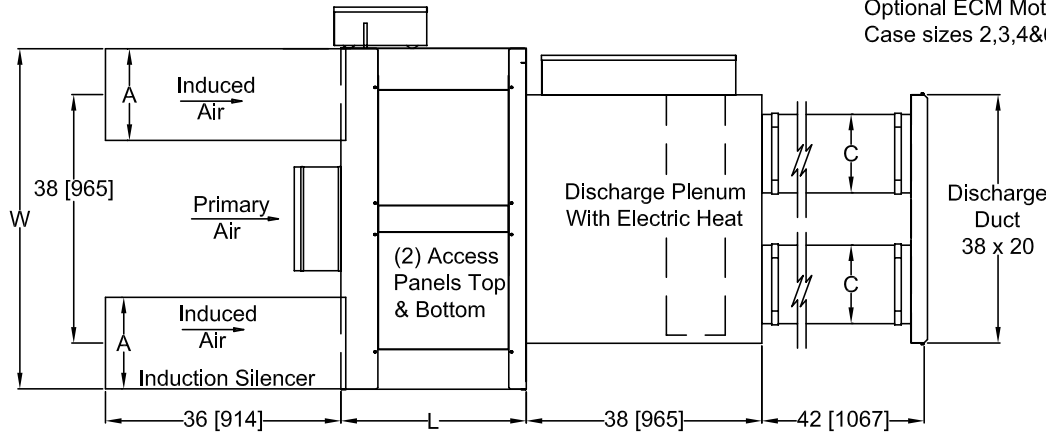

Top View Typical For Case Sizes 6&7

Optional ECM Motor available on Case sizes 2,3,4&6

Case size	Inlet Size		Horsepower		Unit Dimensions			Induction Silencer		Discharge Silencer	
	Standard	Optional	Standard PSC	ECM	Height W	Width W	Length L	Width A	Height B	Width C	Height D
2	8 (203)	4,5,6	1/8	1/3	15	25	24	14	14	12	10
3	10 (254)	4,5,6,8	1/4	1/2	18	29	28	16	18	14	12 1/2
4	12 (305)	6,8,10	1/3	1	18	32 1/2	28	18	18	16	15
5	12 (305)	8,10	1/3	NA	18	32 1/2	28	18	18	16	15
6	16 (406)	10,12,14	1/3(2)	1/2(2)	18	52	30	16	18	16	15
7	18x16 (457x406)	12,14,16	3/4(2)	NA	20	52	30	16	20	16	15

(THIS PAGE INTENTIONALLY LEFT BLANK)

XG-FCQ-700 APPROXIMATE SHIPPING WEIGHTS

Case	XG-FCQ
2	170 lbs.
3	190 lbs.
4	210 lbs.
5	210 lbs.
6	310 lbs.
7	330 lbs.

XG-FCQ-700 FILTER SIZES PER CASE SIZE

Case Size	Filter Dimensions
2	14" x 14"
3	16" x 18"
4	18" x 18"
5	18" x 18"
6	16" x 18" (2)
7	16" x 20" (2)

Filters are mounted on the fan induction and are available in 1" or 2" thickness.



CERTIFICATIONS AND STANDARDS

- Units tested per ASHRAE Standard 130-2016.
- All model sizes certified in accordance with AHRI 880-2017 certification program.
- ETL listed to meet requirements of UL 1995 and CSA 236.
- Dual-density fiberglass insulation meets UL 181 and NFPA 90A/90B.
- Insulation meets ASHRAE 62.1 requirements for resistance to mold growth and erosion.
- Hot water coils are manufactured in accordance to AHRI Standard 410.

XG-FCQ-700 AHRI CERTIFIED RATING POINTS

RADIATED SOUND FAN ONLY

Case-Inlet Size	CFM	Min ΔPs	Octave Band						
			2	3	4	5	6	7	
2-08	400	0.10	51	46	42	37	31	27	
3-10	900	0.11	58	55	49	46	40	34	
4-12	1400	0.12	62	55	48	46	42	40	
5-12	1600	0.13	63	58	50	48	44	43	
6-16	2500	0.14	67	60	54	53	50	48	
7-18x16	2800	0.15	69	63	57	53	49	47	

RADIATED SOUND
Power Levels @ 1.5" w.g. ΔPs

Case-Inlet Size	CFM	Min ΔPs	Octave Band						
			2	3	4	5	6	7	
2-08	400	0.10	57	51	47	42	39	39	
3-10	900	0.11	64	60	54	50	50	52	
4-12	1400	0.12	68	60	51	50	46	46	
5-12	1600	0.13	69	62	53	52	48	48	
6-16	2500	0.14	73	65	59	57	55	54	
7-18x16	2800	0.15	72	66	58	53	51	51	

DISCHARGE SOUND FAN ONLY

Case-Inlet Size	CFM	Min ΔPs	Octave Band						
			2	3	4	5	6	7	
2-08	400	0.10	51	45	41	37	32	28	
3-10	900	0.11	56	54	48	43	40	47	
4-12	1400	0.12	61	58	53	49	47	54	
5-12	1600	0.13	61	59	53	49	48	54	
6-16	2500	0.14	64	61	49	48	45	51	
7-18x16	2800	0.15	62	62	53	48	47	55	

PERFORMANCE NOTES

- 1) Radiated sound is the noise transmitted through the unit casing
- 2) Discharge sound is noise emitted from unit discharge into downstream ductwork
- 3) Sound power levels expressed in decibels, (dB) re 10⁻¹² Watts
- 4) Min ΔPs is the min. operating pressure requirement of the unit with the damper full open and is the static pressure drop from the unit inlet to the unit discharge
- 5) Performance data based on laboratory tests conducted in accordance with ASHRAE 130-2016 and AHRI 880-2017
- 6) Discharge sound power levels include duct end reflection corrections per AHRI Standard 880-2017
- 7) Sound performance based on units lined with standard dual density fiberglass insulation
- 8) Discharge (external) static pressure is 0.25" w.g. for all cases

RADIATED SOUND MODEL XG-FCQ - PSC MOTOR

OCTAVE BAND SOUND POWER, Lw, dB																														
Case-Inlet Size	CFM	Min ΔPs	FAN ONLY							ΔPs = 0.50 in. wg.							ΔPs = 1.0 in. wg.							ΔPs = 1.5 in. wg.						
			2	3	4	5	6	7	NC	2	3	4	5	6	7	NC	2	3	4	5	6	7	NC	2	3	4	5	6	7	NC
2-08	200	0.10	46	42	38	29	27	24	<15	50	46	42	34	33	32	15	50	47	42	34	34	34	15	52	49	44	36	36	36	18
	300	0.10	49	44	40	33	29	26	<15	51	47	43	35	33	32	16	51	47	43	35	34	34	16	53	49	45	37	36	36	19
	400	0.10	51	46	42	37	31	27	15	54	49	45	40	36	35	19	55	49	45	40	37	37	19	57	51	47	42	39	39	21
	500	0.10	52	47	43	37	32	28	17	55	50	46	39	35	34	20	56	51	46	39	36	35	20	58	53	48	41	38	37	22
	600	0.10	53	49	44	37	33	30	18	56	51	47	38	36	35	21	57	51	47	38	36	36	21	59	53	49	40	38	38	23
3-10	500	0.11	52	53	46	43	34	27	21	56	55	49	45	44	45	24	58	55	49	45	46	50	24	59	57	51	47	48	51	26
	700	0.11	55	54	48	44	37	31	22	58	56	50	46	45	46	25	59	56	50	46	47	50	25	61	58	52	48	49	52	27
	900	0.11	58	55	49	46	40	34	24	61	58	52	48	46	46	28	62	58	52	48	48	50	28	64	60	54	50	50	52	30
	1100	0.11	60	56	51	47	42	37	25	64	59	53	50	48	48	29	65	60	53	50	49	51	30	67	62	55	52	51	53	32
	1300	0.11	63	58	52	49	45	41	27	66	61	55	52	49	49	31	67	62	55	52	50	51	32	69	64	57	54	52	53	35
4-12	1000	0.12	60	51	44	43	39	37	22	61	55	48	46	42	41	24	61	56	49	47	43	42	25	61	56	49	47	45	43	25
	1200	0.12	61	53	46	44	40	38	23	64	56	49	47	43	42	28	64	57	50	47	44	43	28	64	58	50	48	46	45	28
	1400	0.12	62	55	48	46	42	40	25	65	58	51	48	45	43	29	66	58	51	48	45	44	30	68	60	51	50	46	46	32
	1600	0.12	63	58	50	48	44	43	27	67	60	53	50	47	46	31	68	60	53	50	47	47	32	69	62	53	52	48	48	34
	1800	0.12	65	60	52	50	46	45	29	68	62	55	53	49	49	32	69	62	55	53	49	50	34	70	64	55	54	50	51	35
5-12	1200	0.13	61	53	46	44	40	38	23	64	56	49	47	43	42	28	64	57	50	47	44	43	28	64	58	50	48	46	45	28
	1400	0.13	62	55	48	46	42	40	25	65	58	51	48	45	43	29	66	58	51	48	45	44	30	68	60	51	50	46	46	32
	1600	0.13	63	58	50	48	44	43	27	67	60	53	50	47	46	31	68	60	53	50	47	47	32	69	62	53	52	48	48	34
	1800	0.13	65	60	52	50	46	45	29	68	62	55	53	49	49	32	69	62	55	53	49	50	34	70	64	55	54	50	51	35
	2000	0.13	67	62	54	52	48	47	31	68	62	55	53	49	49	32	69	62	55	53	49	50	34	70	64	55	54	50	51	35
6-16	1700	0.14	65	56	48	45	40	36	28	68	61	53	49	45	43	32	68	62	54	50	46	44	32	69	63	55	51	47	45	34
	2100	0.14	67	58	50	47	44	40	31	70	62	55	51	48	46	35	70	63	56	52	49	47	35	72	64	57	53	51	48	38
	2500	0.14	67	60	54	53	50	48	31	71	63	57	56	53	52	36	72	64	58	56	54	53	38	73	65	59	57	55	54	39
	2900	0.14	70	63	57	56	53	51	35	73	65	59	58	55	54	39	74	66	60	58	56	55	40	75	67	61	59	57	57	41
	3300	0.14	71	65	58	57	54	53	36	75	68	61	60	57	58	41	76	68	62	60	58	59	42	77	69	63	61	59	60	44
7-18x16	1800	0.15	69	58	52	47	42	38	34	69	61	54	49	46	47	34	70	61	54	49	47	49	35	70	62	55	50	49	50	35
	2300	0.15	68	60	55	50	46	43	32	69	62	55	50	47	48	34	69	62	55	50	48	49	34	70	63	56	51	49	50	35
	2800	0.15	69	63	57	53	49	47	34	71	64	57	52	50	49	36	71	64	57	52	50	50	36	72	66	58	53	51	51	38
	3300	0.15	70	66	62	57	56	47	37	73	67	63	56	54	51	39	74	67	63	56	54	52	40	75	69	64	57	55	53	41
	3800	0.15	72	68	65	59	57	48	41	75	70	66	59	57	53	41	76	70	66	59	57	54	42	77	71	68	61	58	55	44

- 1) AHRI certified data is highlighted while all other data are application ratings
- 2) Radiated sound is the noise transmitted through the unit casing
- 3) Sound power levels expressed in decibels, (dB) re 10⁻¹² Watts
- 4) Min ΔPs is the minimum operating pressure requirement of the unit with the damper full open and is the static pressure drop from the unit inlet to the unit discharge
- 5) Performance data based on laboratory tests conducted in accordance with ASHRAE 130-2016 and AHRI 880-2017
- 6) NC values are calculated using attenuation credits outlined in AHRI 885-2008 Appendix E
- 7) Blank spaces indicate Minimum Ps if unit exceeds the ΔPs across the unit
- 8) Sound performance based on units lined with standard dual density fiberglass insulation
- 9) Discharge (external) static pressure is 0.25" w.g. for all cases

SERIES FAN POWERED XG-FCQ-700 ULTRA QUIET

DISCHARGE SOUND MODEL XG-FCQ - PSC MOTOR

OCTAVE BAND SOUND POWER, Lw, dB																														
Case-Inlet Size	CFM	Min ΔPs	FAN ONLY							ΔPs = 0.50 in. wg.							ΔPs = 1.0 in. wg.							ΔPs = 1.5 in. wg.						
			2	3	4	5	6	7	NC	2	3	4	5	6	7	NC	2	3	4	5	6	7	NC	2	3	4	5	6	7	NC
2-08	200	0.10	46	41	37	33	28	23	<15	59	48	41	36	32	27	<15	60	49	41	36	32	27	15	62	51	43	38	34	29	18
	300	0.10	49	43	39	35	30	25	<15	60	49	42	37	33	28	<15	61	50	42	37	33	28	<15	63	52	44	39	35	30	15
	400	0.10	51	45	41	37	32	28	<15	63	51	44	39	35	30	15	64	52	44	39	35	30	16	66	54	46	41	37	32	19
	500	0.10	52	46	42	38	34	28	<15	64	52	46	41	37	31	16	65	53	46	41	37	32	18	67	55	48	43	39	34	20
600	0.10	54	48	43	40	35	30	<15	66	54	47	43	38	33	19	67	55	47	43	39	34	20	69	57	49	45	41	36	22	
3-10	500	0.11	50	49	44	40	34	37	<15	62	56	49	44	38	42	<15	64	58	49	44	40	44	16	65	59	50	44	41	44	18
	700	0.11	53	52	46	41	37	42	<15	64	58	50	44	40	45	<15	65	59	50	44	41	46	15	67	60	51	45	42	47	18
	900	0.11	56	54	48	43	40	47	<15	67	60	52	46	43	50	18	68	61	52	46	44	51	19	70	62	53	47	45	52	21
	1100	0.11	58	56	51	44	42	51	15	69	62	55	47	45	54	20	70	63	55	47	46	55	21	72	65	56	48	48	56	24
1300	0.11	61	58	53	45	45	55	19	72	64	57	48	48	58	24	73	65	57	48	49	59	25	75	67	58	49	50	60	28	
4-12	1000	0.12	57	53	48	45	42	47	<15	62	55	48	45	42	47	<15	62	55	48	45	42	47	<15	62	55	48	45	43	47	<15
	1200	0.12	59	56	50	47	44	50	<15	64	58	50	47	44	50	<15	64	58	50	47	45	50	<15	65	58	50	47	45	50	15
	1400	0.12	61	58	53	49	47	54	18	67	60	54	49	47	54	18	67	60	54	49	47	54	18	68	61	55	49	47	54	19
	1600	0.12	61	59	53	49	48	54	18	68	62	54	50	49	56	20	68	62	54	50	49	56	20	69	63	55	51	50	57	21
1800	0.12	62	59	53	49	48	54	18	69	64	56	52	51	58	22	69	64	57	53	52	59	23	71	65	58	53	53	60	24	
5-12	1200	0.13	59	56	50	47	44	50	<15	64	58	50	47	44	50	<15	64	58	50	47	44	50	<15	65	58	50	47	44	52	16
	1400	0.13	61	58	53	49	47	54	18	67	60	53	49	47	54	18	67	60	54	49	47	54	18	68	61	55	49	47	54	19
	1600	0.13	61	59	53	49	48	54	18	68	62	54	50	49	56	20	68	62	54	50	49	56	20	69	63	55	51	50	57	21
	1800	0.13	62	59	53	49	48	54	18	69	64	56	52	51	58	22	69	64	57	53	52	59	23	71	65	58	53	53	60	24
2000	0.13	64	61	55	51	50	56	20	69	64	56	52	51	58	22	69	64	57	53	52	59	23	71	65	58	53	53	60	24	
6-16	1700	0.14	58	56	45	46	41	38	<15	69	63	49	50	45	44	20	70	64	49	50	46	45	21	72	66	50	51	47	46	24
	2100	0.14	60	58	47	48	44	45	<15	71	65	50	51	47	49	22	72	66	50	51	48	50	24	74	68	51	52	49	51	26
	2500	0.14	64	61	49	48	45	51	18	74	67	52	51	48	54	26	75	68	52	51	49	55	28	77	70	53	52	50	56	30
	2900	0.14	65	63	53	50	49	56	20	75	69	55	53	51	58	28	76	70	55	53	52	59	29	78	72	56	54	53	60	31
3300	0.14	66	65	55	52	51	59	23	76	71	58	55	54	62	30	77	72	58	55	55	63	31	79	74	59	56	56	64	34	
7-18x16	1800	0.15	56	57	47	44	41	47	<15	66	63	50	47	44	50	20	67	64	50	47	45	51	21	70	66	51	48	47	52	24
	2300	0.15	60	60	50	46	45	52	16	68	66	52	48	46	53	22	69	66	52	48	47	54	24	72	67	53	49	49	56	25
	2800	0.15	62	62	53	48	47	55	19	71	67	55	50	49	57	25	72	68	55	50	50	58	26	74	69	56	51	52	59	28
	3300	0.15	64	62	54	50	50	58	22	73	68	57	52	52	60	26	74	69	57	52	53	61	28	76	71	58	53	54	62	30
3800	0.15	66	64	57	52	53	62	26	75	69	59	54	55	63	28	76	70	59	54	56	64	29	79	72	60	55	57	65	32	

SERIES FAN POWERED

XG-FCQ-700 ULTRA QUIET

- AHRI certified data is highlighted while all other data are application ratings
- Discharge sound is noise emitted from unit discharge into downstream ductwork
- Sound power levels expressed in decibels, (dB) re 10⁻¹² Watts
- Min ΔPs is the min. operating pressure requirement of the unit with the damper full open and is the static pressure drop from the unit inlet to the unit discharge
- Performance data based on laboratory tests conducted in accordance with ASHRAE 130-2016 and AHRI 880-2017
- NC values are calculated using attenuation credits outlined in AHRI 885-2008 Appendix E
- Blank spaces indicate Minimum Ps if unit exceeds the ΔPs across the unit
- Sound performance based on units lined with standard dual density fiberglass insulation
- Discharge sound power levels include duct end reflection corrections per AHRI Standard 880-2017
- Discharge (external) static pressure is 0.25" w.g. for all cases

XG-FCQ-700 PSC FAN MOTOR AMPERAGE RATINGS

Case Size	Motor HP	Standard PSC Motor Amperage Ratings		
		120v-1 Phase 60 Hz Rated Amps	208-240V-1 Phase 60 Hz Rated Amps	277V-1 Phase 60 Hz Rated Amps
2	1/8	2.6	0.8	1.1
3	1/4	4.8	1.9	1.9
4	1/3	8.8	3.0	1.9
5	1/3	8.8	3.0	3.6
6	1/3 (two motors)	17.6 (two motors)	12.4 (two motors)	12.4 (two motors)
7	3/4 (two motors)	22.8 (two motors)	8.0 (two motors)	8.6 (two motors)

XG-FCQ-700 ECM FAN MOTOR AMPERAGE RATINGS

Case Size	Motor HP	ECM Motor Amperage Ratings		
		120v-1 Phase 60 Hz Rated Amps	208-240V-1 Phase 60 Hz Rated Amps	277V-1 Phase 60 Hz Rated Amps
2	1/3	4.2	2.7	2.1
3	1/2	6.6	3.8	3.2
4	1	11.8	6.6	6.0
6	1/2 (two motors)	13.2 (two motors)	7.6 (two motors)	6.4 (two motors)

XG-FCQ-700 DAMPER LEAKAGE

Standard Construction			
Inlet Diameter	Static Pressure " w.g.	Maximum Airflow	Max Damper Leakage
4	3	300	5
5	3	375	5
6	3	540	5
7	3	760	7
8	3	990	9
9	3	1250	12
10	3	1640	16
12	3	2350	22
14	3	3250	32
16	3	4100	41
20	3	6430	64
24	3	7270	72

PERFORMANCE NOTES

- 1) Leakage testing conducted in accordance with ASHRAE 130-2016
- 2) Per ASHRAE Standard 130-2016 "terminal damper leakage: the amount of air in ft³/min (L/s) leaking through a fully closed damper/valve of a supply/exhaust terminal unit at a given inlet pressure"opened"

- 3) Damper leakage shall not exceed 1% of the maximum rated airflow at 3" w.g.
- 4) 4" and 5" inlets are built with 6" casings

XG-FCQ-700 AIR TERMINALS ACCESSORIES AND COMPONENTS OPTIONAL ELECTRONIC ANTI-REVERSE ROTATION DEVICE

The fan wheel in a constant fan box may rotate backward whenever the fan motor is not running and primary air from the inlet duct is passing through the fan. In some cases the torque developed by the fan wheel when rotating backward cannot be overcome by the starting torque of the fan motor. In this condition the fan motor will run in reverse rotation, resulting in insufficient airflow delivery.

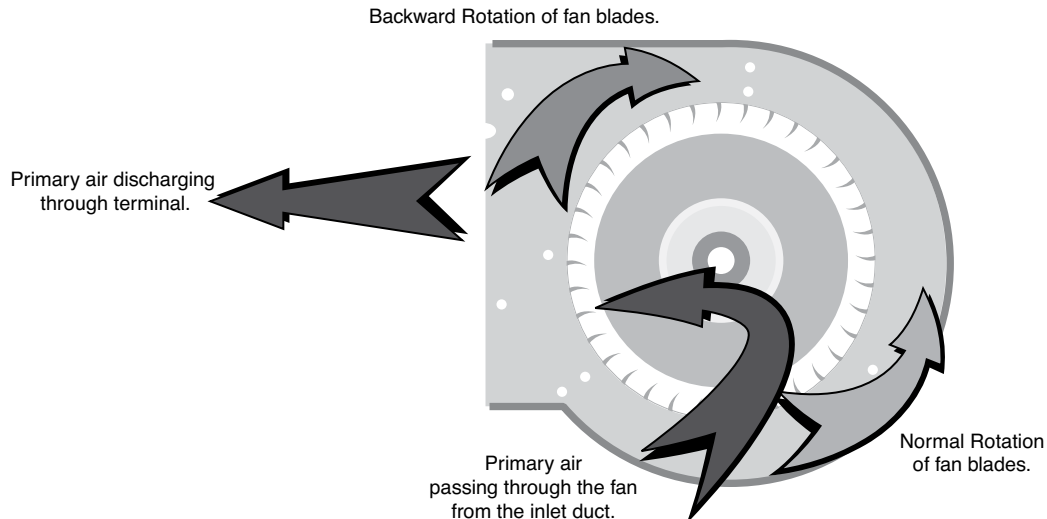

Systems with constant fan boxes must have means to coordinate energizing the fan motor with start up of the Primary Fan System to prevent the reverse rotation of the terminal unit family. This is accomplished by proper operation and staging by the building control system. Another option is to create enough motor torque to reverse the rotation of the fan wheel.

Other manufacturers choose to deal with this issue by running their motors with larger capacitors than recommended by the motor manufacturer. The oversized capacitor will cause the motor to run less efficiently, run hotter than normal and draw more current than with a proper capacitor. All of this will result in reduced motor life and increased energy costs.

Greenheck'S Model XG-FCQ-700 is available with an optional Electronic Anti-Reverse Rotation Device which will positively correct the reverse rotation of any fan. This option does not draw additional current while the motor is running and will not cause the motor to run at higher temperatures. This is a significant advantage.

The results are greater efficiency, quieter motors, longer motor life and happier building owners.

XG-FCQ-700 HOT WATER COILS

When ordered with the air terminal, the hot water coil is shipped attached with slip and drive connections to the air terminal casing. The discharge end of the casing has slip and drive connections for easy connection to downstream ductwork.

Coil selection can be made using Greenheck's Air Terminal Unit Selection Software. Contact your representative for a copy. In the interest of energy conservation and due to the possibility of condensation, all hot water coils are marked "Coil must be externally insulated after installation in the field." Hot water coils are tested in accordance with AHRI Standards 410. Hot water coils may be ordered with optional access doors for inspection and cleaning to meet requirements of ASHRAE Standard 62.1.

HOT WATER COIL CONSTRUCTION DETAILS

- Hot Water Coils are factory mounted to the discharge of the terminal and are available with an optional factory mounted discharge plenum section with access door.
- Hot water coils are enclosed in a 20 gauge coated steel casing allowing for attachment to metal ductwork with a slip and drive connection.
- Fins are rippled and sine wave type constructed from heavy gauge aluminum and are mechanically bonded to the tubes.
- Tubes are copper with a minimum wall thickness of 0.016" with male sweat header connections.
- Coils are leak tested to 300 psi with minimum burst of 2000 psi at ambient temperature. Coil performance data is based on tests run in accordance with AHRI standard 410. Coils are AHRI certified and include an AHRI label.



Outside Diameter (OD) connection size, Inches		
Case Size	Standard HW Coil Inches	
	1 Row	2 Row
2	5/8 (15.8)	7/8 (22.2)
3	5/8 (15.8)	7/8 (22.2)
4	7/8 (22.2)	7/8 (22.2)
5	7/8 (22.2)	7/8 (22.2)
6	7/8 (22.2)	7/8 (22.2)
7	7/8 (22.2)	7/8 (22.2)

All coils have 10 fins per inch

**All accessories that can be attached to the Series Fan Boxes
are not a part of the AHRI certification program
but ratings can be affected by their use.**

XG-FCQ-700 HOT WATER COILS MBH SELECTION DATA

Case Size	Rows	GPM	Head Loss (ft-H ₂ O)	CFM				
				200	400	500	600	750
2	One	1	0.64	8.9	12.1	13.1	14.0	15.0
		2	2.46	9.7	13.5	14.8	16.0	17.4
		4	9.40	10.1	14.4	15.9	17.2	18.9
		Airside Ps	0.02	0.07	0.11	0.15	0.22	
2	Two	2	0.62	15.0	22.0	24.4	26.4	28.9
		4	2.38	16.0	24.3	27.3	29.9	33.2
		8	9.10	16.6	25.7	29.1	32.1	36.0
		Airside Ps	0.05	0.16	0.23	0.32	0.46	

Case Size	Rows	GPM	Head Loss (ft-H ₂ O)	CFM				
				1000	1200	1400	1600	1800
5	One	3	1.19	28.4	30.5	32.2	33.8	35.1
		6	4.54	31.1	33.6	35.7	37.6	39.4
		9	9.93	32.1	34.8	37.1	39.2	41.1
		Airside Ps	0.11	0.15	0.19	0.24	0.30	
5	Two	4	1.32	48.8	52.9	56.3	59.3	62.0
		8	5.19	54.6	59.8	64.4	68.4	72.0
		10	8.06	56.0	61.5	66.3	70.6	74.4
		Airside Ps	0.23	0.32	0.41	0.51	0.62	

Case Size	Rows	GPM	Head Loss (ft-H ₂ O)	CFM				
				500	700	900	1100	1300
3	One	4	1.64	18.6	21.6	24.0	25.9	27.6
		8	6.27	19.7	23.0	25.7	28.0	29.9
		10	9.66	19.9	23.3	26.1	28.4	30.4
		Airside Ps	0.06	0.10	0.15	0.22	0.29	
3	Two	4	1.84	31.0	36.9	41.5	45.3	48.5
		6	4.09	32.5	39.1	44.3	48.7	52.4
		8	7.19	33.3	40.3	45.9	50.6	54.6
		Airside Ps	0.12	0.22	0.33	0.46	0.61	

Case Size	Rows	GPM	Head Loss (ft-H ₂ O)	CFM				
				1500	2000	2500	3000	3300
6	One	4	1.43	58.3	65.6	71.3	76.0	78.5
		8	5.61	65.1	74.5	82.1	88.5	91.9
		10	8.71	66.7	76.6	84.7	91.6	95.2
		Airside Ps	0.03	0.05	0.07	0.10	0.12	
6	Two	4	1.07	87.6	99.6	108.8	116.2	120.0
		8	4.22	102.2	119.4	133.3	145.0	151.1
		12	9.42	108.2	127.7	144.0	157.8	165.2
		Airside Ps	0.07	0.11	0.16	0.21	0.25	

Case Size	Rows	GPM	Head Loss (ft-H ₂ O)	CFM				
				1000	1200	1400	1600	1800
4	One	3	1.19	28.4	30.5	32.2	33.8	35.1
		6	4.54	31.1	33.6	35.7	37.6	39.4
		9	9.93	32.1	34.8	37.1	39.2	41.1
		Airside Ps	0.11	0.15	0.19	0.24	0.30	
4	Two	4	1.32	48.8	52.9	56.3	59.3	62.0
		8	5.19	54.6	59.8	64.4	68.4	72.0
		10	8.06	56.0	61.5	66.3	70.6	74.4
		Airside Ps	0.23	0.32	0.41	0.51	0.62	

Case Size	Rows	GPM	Head Loss (ft-H ₂ O)	CFM				
				2000	2500	3000	3500	4000
7	One	4	1.43	65.6	71.3	76.0	80.0	83.4
		8	5.61	74.5	82.1	88.5	94.1	98.9
		10	8.71	76.6	84.7	91.6	97.5	102.7
		Airside Ps	0.05	0.07	0.10	0.13	0.16	
7	Two	4	1.07	99.6	108.8	116.2	122.2	127.3
		8	4.22	119.4	133.3	145.0	154.9	163.5
		12	9.42	127.7	144.0	157.8	169.8	180.3
		Airside Ps	0.11	0.16	0.21	0.27	0.34	

- 1) All coil performance in accordance with AHRI Standard 410-2001
- 2) Heating capacities are in MBH
- 3) Performance data based on a temperature differential of 115°F (180°F entering water temperature and 65°F entering air temperature)
- 4) For temperature differentials other than 115°F, multiply the MBH by the correction factors below

- 5) Head Loss is in feet of water
- 6) Airside ΔPs is the air pressure drop of the hot water coil
- 7) Aire temperature rise = 927 x MBH/CFM
- 8) Water temperature drop = 2.04 x MBH/GPM
- 9) Values in tables are listed for 0 ft. of altitude and no glycol in the system

MBH CORRECTION FACTORS

ΔT	50	60	70	80	90	100	115	125	140	150
Factor	0.44	0.52	0.61	0.70	0.79	0.88	1.00	1.07	1.20	1.30

XG-FCQ-700 ELECTRIC HEAT

The discharge end has slip and drive connections for easy connection to downstream ductwork. ETL® listed heaters are provided with a fan interlock relay. Heaters that will be controlled electronically must include a 24 VAC control circuit to operate with the low voltage controls on the air terminal. Heater plenums are internally insulated. When an air terminal is ordered with clean room lining and electric heat, the heater plenum is either internally lined with optional foil backed insulation or closed cell foam or may require external insulation in field.

INCLUDED WITH EACH HEATER ASSEMBLY:

- Heater and cabinet mounted on the discharge of the XG-FCQ-700
- Electric Heater is interlocked into fan control relay
- De-energizing magnetic contactors per step
- Primary automatic reset high temperature limit (disc type)
- Backup manual reset high temperature limit (disc type)
- Non-fused transformer with voltage to match Heater voltage
- Single point power wiring connection
- Heater is shipped factory mounted and wired



ELECTRIC HEATER ASSEMBLY CONSTRUCTION DETAILS

- Electric Reheat Coils are factory mounted on the discharge of the Air Terminal. The heaters are ETL® listed for zero clearance, are tested in accordance with UL® Standard 1995, CSA-C22.2 No. 236 and the National Electric Code (NEC). Heater casings are constructed of galvanized steel. Element wire is high grade nichrome alloy derated to 45 watts per square inch density. Element wire is supported by moisture-resistant steatite ceramics.
- Ceramics are enclosed in reinforcement brackets spaced across the heater element rack at 2" to 4" intervals. Controls are contained in a NEMA 1 control cabinet with a hinged, latching door. A permanent wiring diagram is affixed to the inside of the control cabinet door for field reference.
- The 208 and 480 volt units require a neutral connection for both single and three phase service. Our standard motors are 120 and 277 volt single phase. The 208-240 volt single phase motor is optional. 480 volt motors are not available for our units. See table for reference.

Heater Voltage	Fan Motor Voltage	Separate Neutral Required
120 V 1PH	120 V 1PH	NO
208 V 1PH	120 V 1PH	YES
277 V 1PH	277 V 1PH	NO
480 V 1PH	277 V 1PH	YES
208 V 1PH	208 V 1PH	NO
208 V 3PH	120 V 1PH	YES
480 V 3PH	277 V 1PH	YES
208 V 3PH	208 V 1PH	NO

All accessories that can be attached to the Series Fan Boxes
are not a part of the AHRI certification program
but ratings can be affected by their use.

XG-FCQ-700 ELECTRIC HEATER CAPACITIES

Single Phase XG-FCQ kW Limits				
Case Size	Heater Voltage	Min. kW per Step	Max. kW	Max. Steps
2	120	0.5	5	2
2	208	0.5	9	2
2	240	0.5	9	2
2	277	1.0	9	2
2	480	2.0	9	2
3	120	0.5	5	3
3	208	0.5	9.5	3
3	240	0.5	11	3
3	277	0.5	13	3
3	480	1.0	13	3
4	120	0.5	5	3
4	208	0.5	9.5	3
4	240	0.5	11	3
4	277	0.5	13	3
4	480	1.0	19	3
5	120	0.5	5	3
5	208	0.5	9.5	3
5	240	0.5	11	3
5	277	0.5	13	3
5	480	1.0	23	3
6	120	0.5	5	3
6	208	0.5	9.5	3
6	240	0.5	11	3
6	277	0.5	13	3
6	480	0.5	23	3
7	120	0.5	5	3
7	208	0.5	9.5	3
7	240	0.5	11	3
7	277	0.5	13	3
7	480	0.5	23	3

Three Phase XG-FCQ kW Limits				
Case Size	Heater Voltage	Min. kW per Step	Max. kW	Max. Steps
2	208	0.5	9	2
2	480	2.5	9	2
3	208	0.5	13	3
3	480	1.0	13	3
4	208	0.5	17	3
4	480	1.0	19	3
5	208	0.5	17	3
5	480	0.5	24	3
6	208	0.5	17	3
6	480	0.5	39	3
7	208	0.5	17	3
7	480	0.5	39	3

NOTES:

1. Heaters less than 10 kW are specifiable to nearest 0.5 kW. Heaters greater than 10.0 kW are specifiable to nearest 1.0 kW.
2. Minimum flow rate for electric heat is 70 CFM / kW. Lower CFM's can cause nuisance tripping, excessive discharge temperatures, rapid cycling, and rapid element failure. Electric Heat units running below 70 CFM / kW will void all warranties.
3. For optimum thermal comfort, the suggested discharge temperature should not exceed 20°F above room set point.
4. We do not recommend discharge temperatures in excess of 115°F to protect heater coils.
5. Maximum number of steps at minimum kW per Step is one step.
6. If more than 1 heater is wired into a building's circuit breaker (multi-outlet branch circuit) each heater will require the addition of power side fusing.

ELECTRIC HEAT SELECTION:

A. Specify electric duct heaters using voltage, phase, kW, and number of steps.

B. Use above chart to select voltage. Calculate required kW using following equations:

$$kW = \frac{BTU / HR}{3413} \qquad kW = \frac{CFM \times \Delta \times 1.085}{3413} \qquad \Delta = \frac{kW \times 3413}{CFM \times 1.085}$$

$$CFM = \frac{kW \times 3413}{\Delta \times 1.085} \qquad CFM = \frac{kW \times 3413}{\Delta \times 1.085}$$

* air density at sea level — reduce by 0.036 for each 1000 feet of altitude above sea level

Where: BTU / Hr = Required heating capacity

CFM = volume of air during heating. Typically 100% of maximum cooling air volume

Δ = desired air temperature rise across the electric heater

Inlet air temperature = primary air temperature, usually 55°F

XG-FCQ-700 CONTROL SEQUENCE OFFERINGS



PPD-PNEUMATIC PRESSURE DEPENDENT

- Direct Acting / Normally Closed (DA / NC)
- Reverse Acting / Normally Open (RA / NO)



PPI-PNEUMATIC PRESSURE INDEPENDENT

- Direct Acting / Normally Closed (DA / NC)
- Direct Acting / Normally Open (DA / NO)
- Reverse Acting / Normally Closed (RA / NC)
- Reverse Acting / Normally Open (RA / NO)



EPD-ELECTRIC PRESSURE DEPENDENT

- Cooling Only
- Cooling with Heat
- Night Shutdown / Morning Warm-up
- Heating / Cooling Changeover



API-ANALOG PRESSURE INDEPENDENT

- Consult Factory



DDC-DIRECT DIGITAL CONTROL

BACnet

- Constant Fan—No Auxiliary Heating
- Constant Fan—Modulating Floating Control—Hot Water Heat
- Electric Heat

XG-FCQ-700 FAN PERFORMANCE CURVES CASE 2 - PSC MOTOR

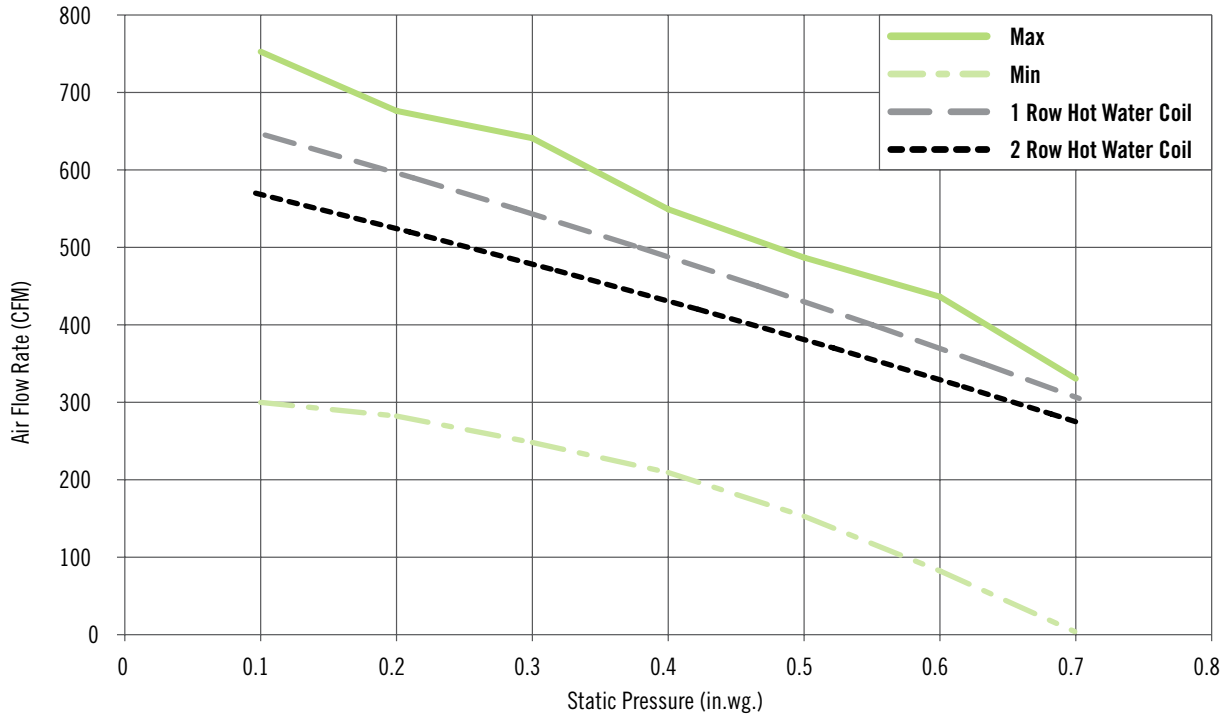

XG-FCQ-700 FAN PERFORMANCE CURVES CASE 3 - PSC MOTOR

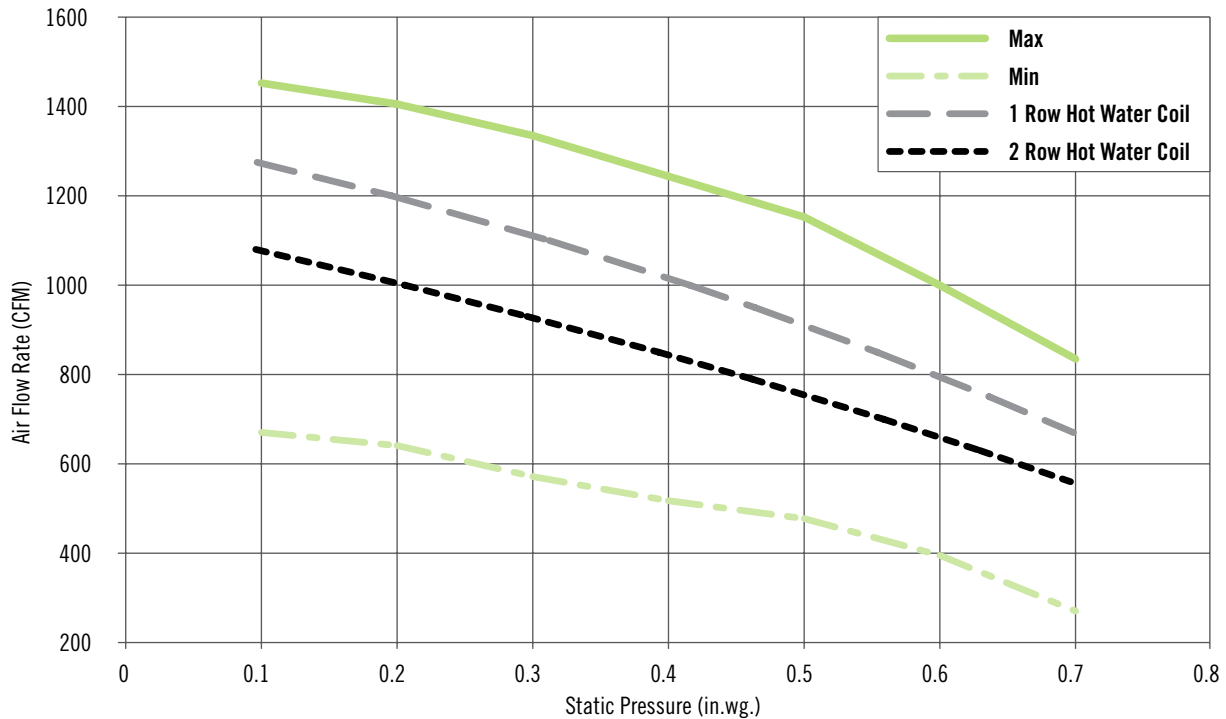

**XG-FCQ-700 FAN PERFORMANCE CURVES
CASE 4 - PSC MOTOR**

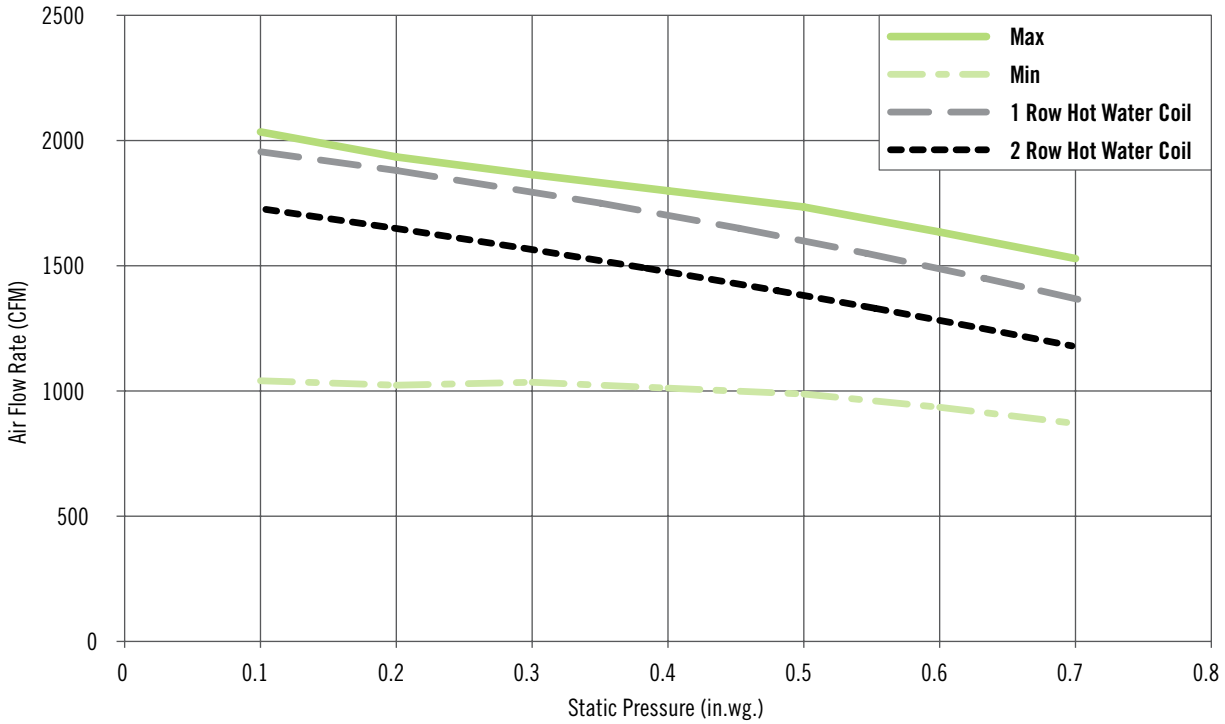

**XG-FCQ-700 FAN PERFORMANCE CURVES
CASE 5 - PSC MOTOR**

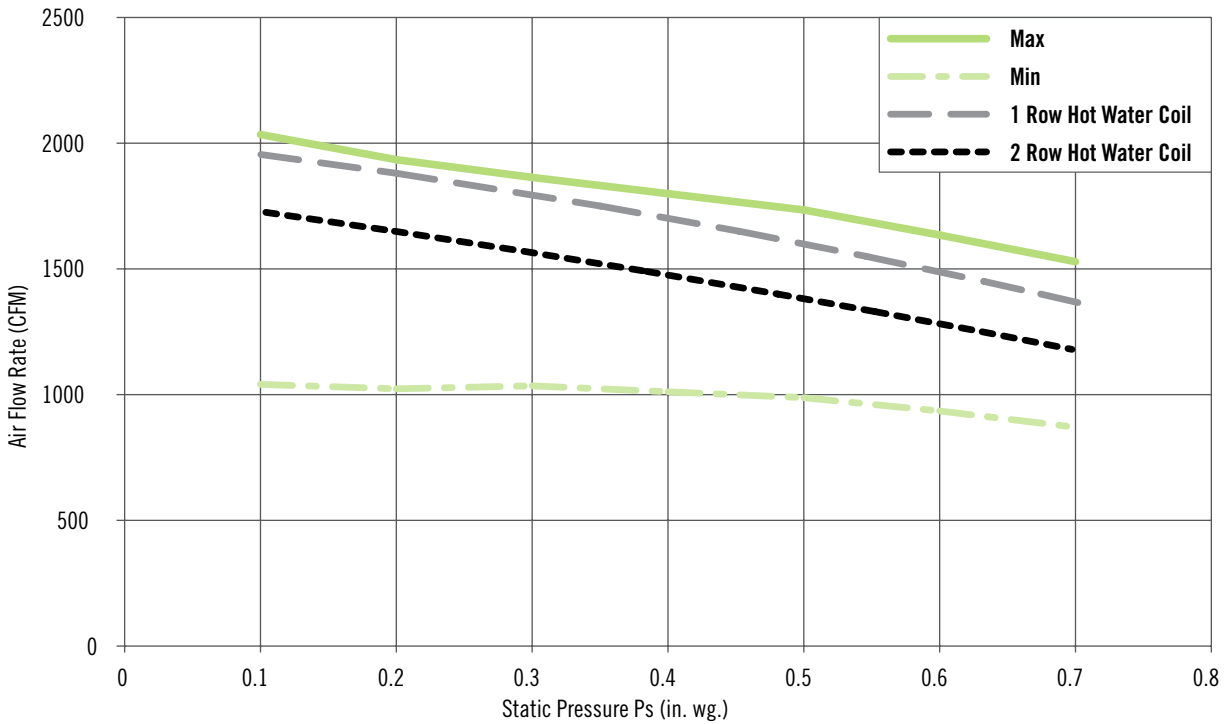

XG-FCQ-700 FAN PERFORMANCE CURVES CASE 6 - PSC MOTOR

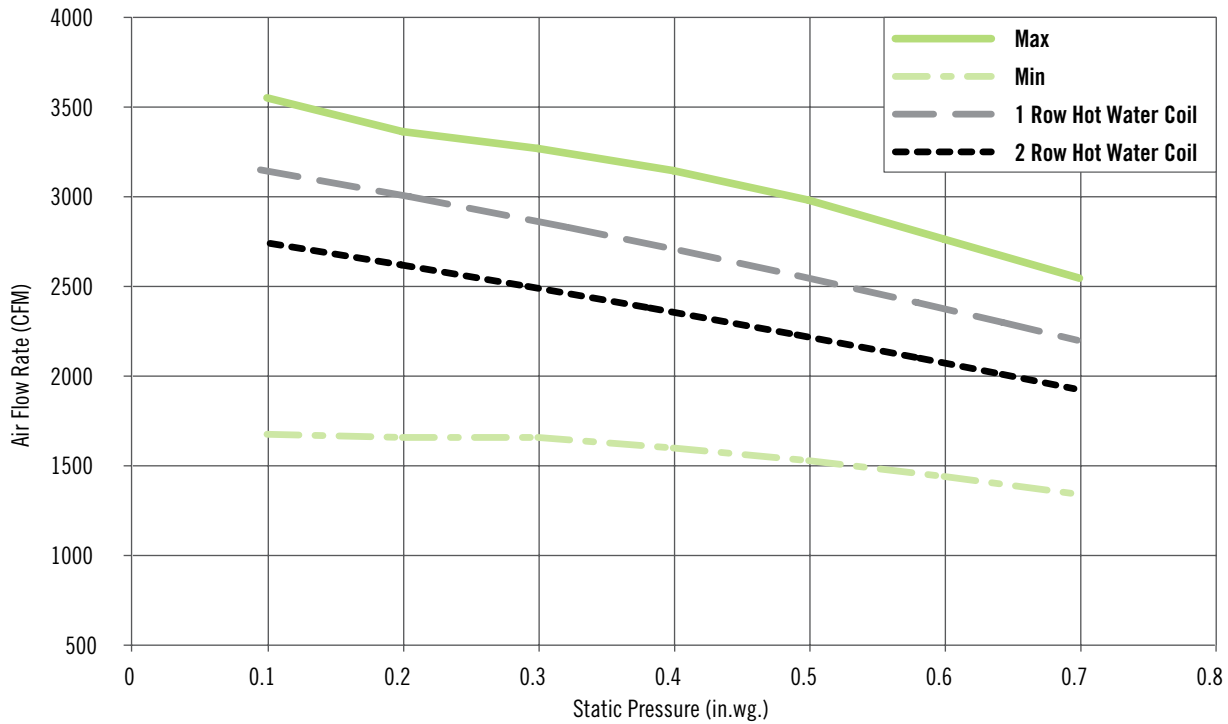

XG-FCQ-700 FAN PERFORMANCE CURVES CASE 7 - PSC MOTOR

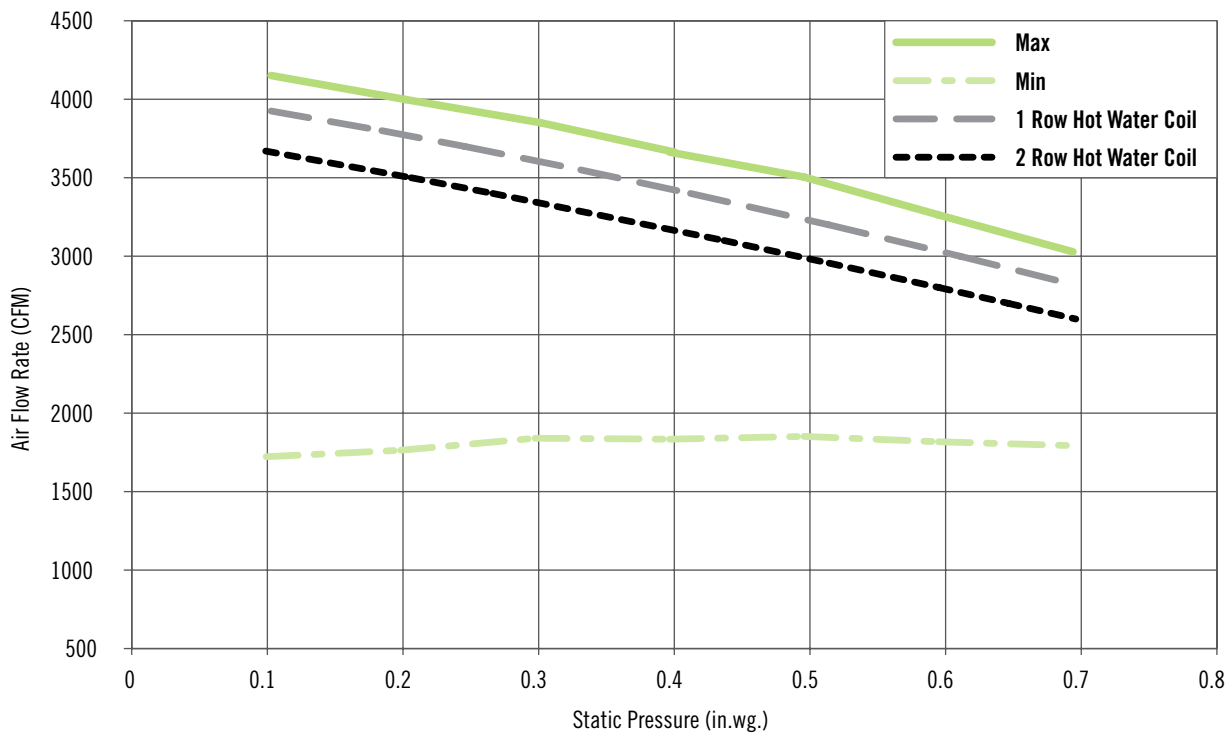

SERIES FAN POWERED

XG-FCQ-700 ULTRA QUIET

XG-FCQ 700 ECM FAN PERFORMANCE CURVES CASE 2

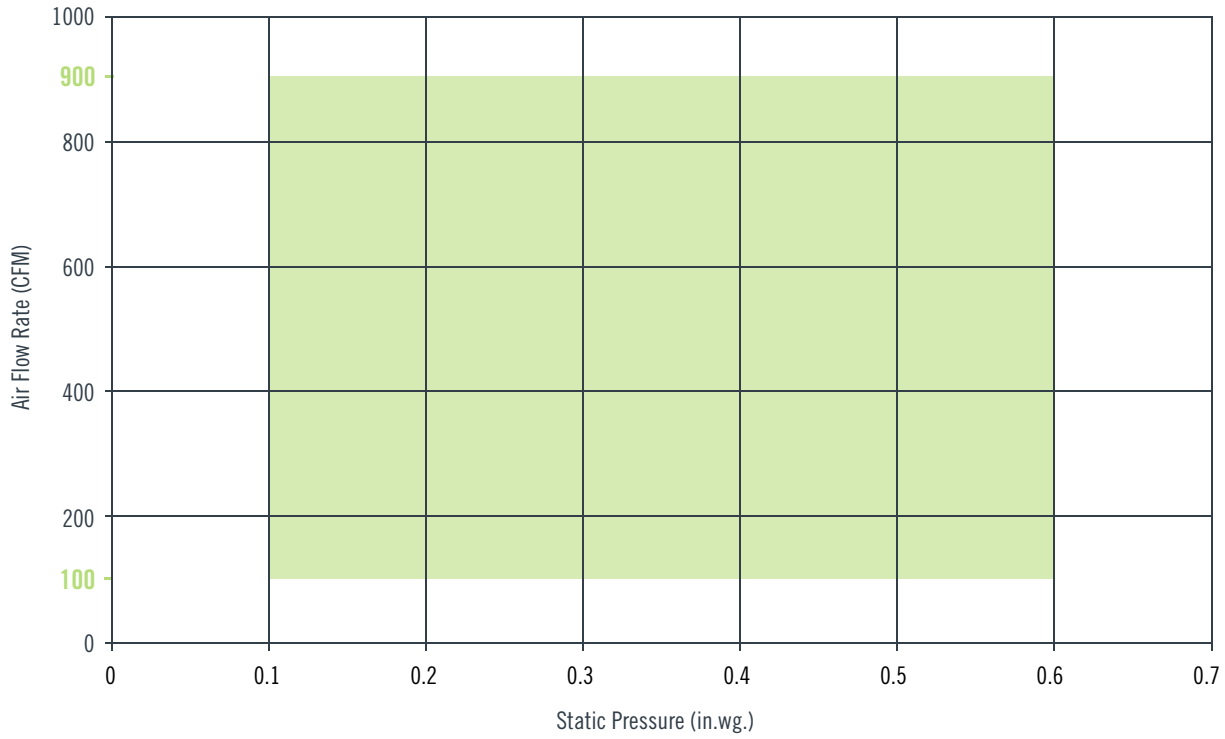

XG-FCQ 700 ECM FAN PERFORMANCE CURVES CASE 3

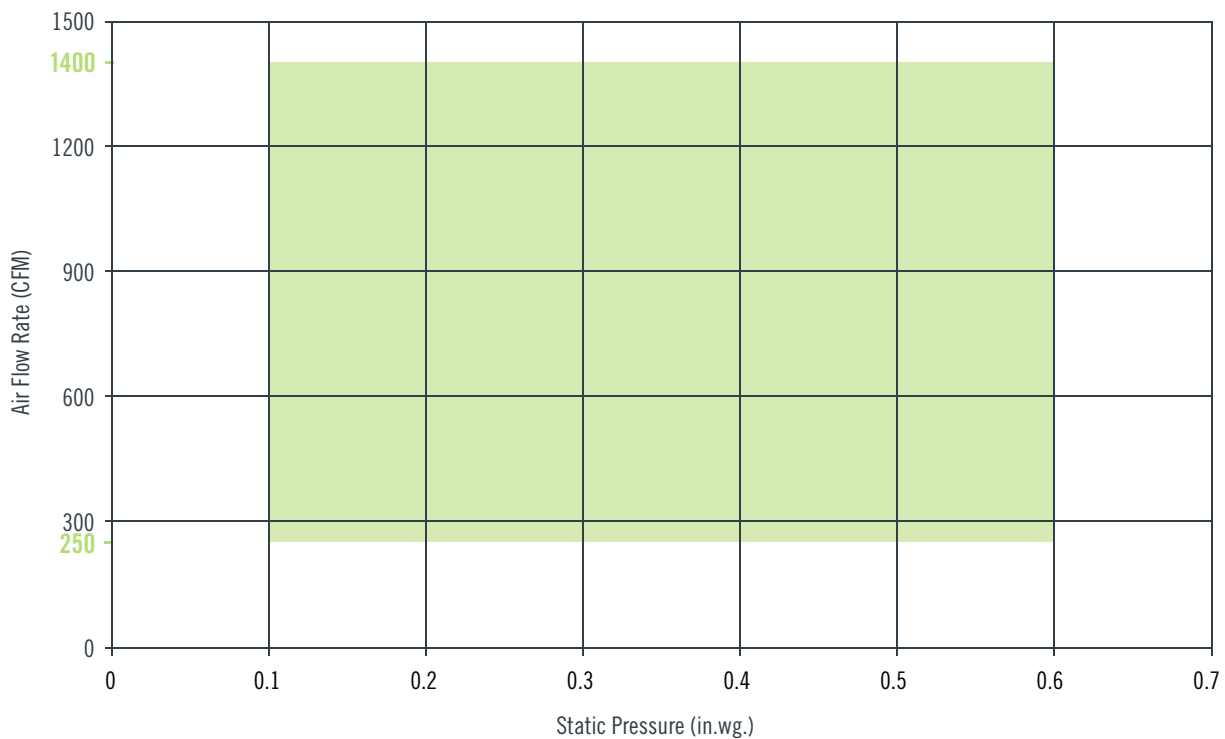

XG-FCQ 700 ECM FAN PERFORMANCE CURVES CASE 4

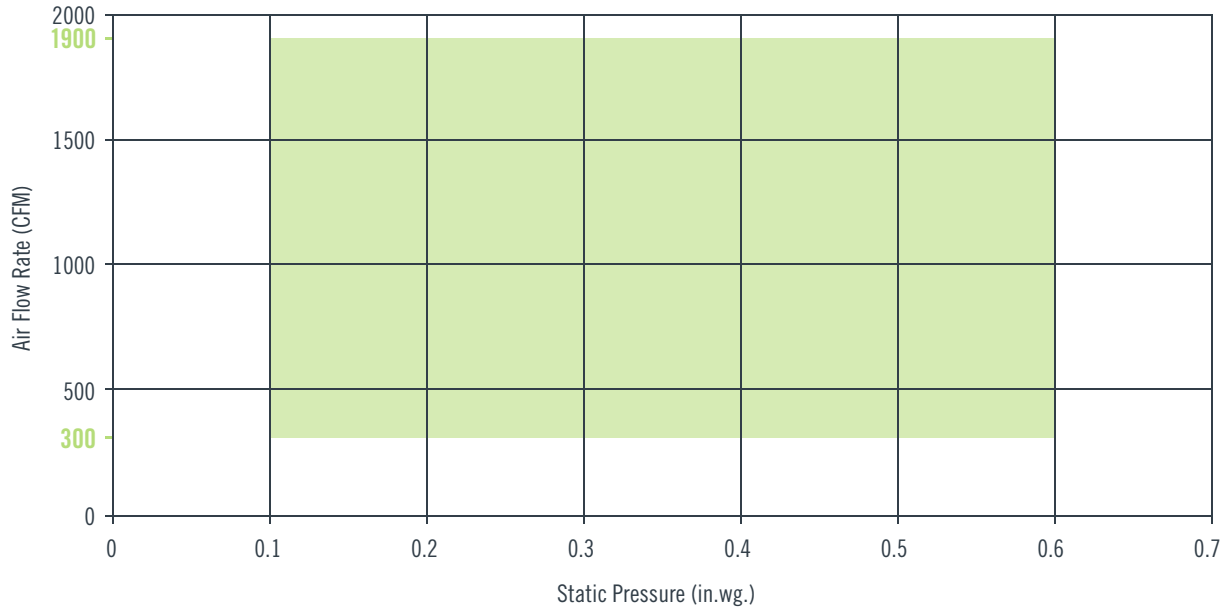

XG-FCQ 700 ECM FAN PERFORMANCE CURVES CASE 6

