

Model: XG-DD-REC-DC Rectangular - Duct Cover

XG-DD-REC-DC - Rectangular - Duct Cover

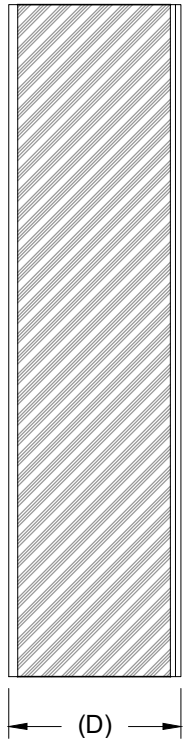

Front View

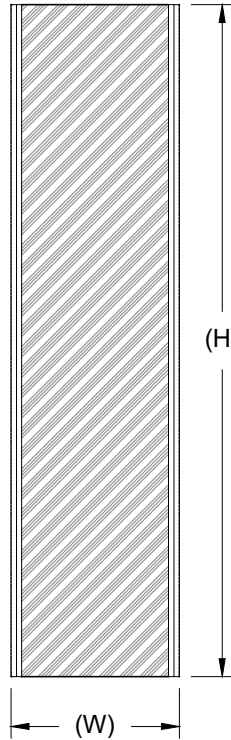

Side View

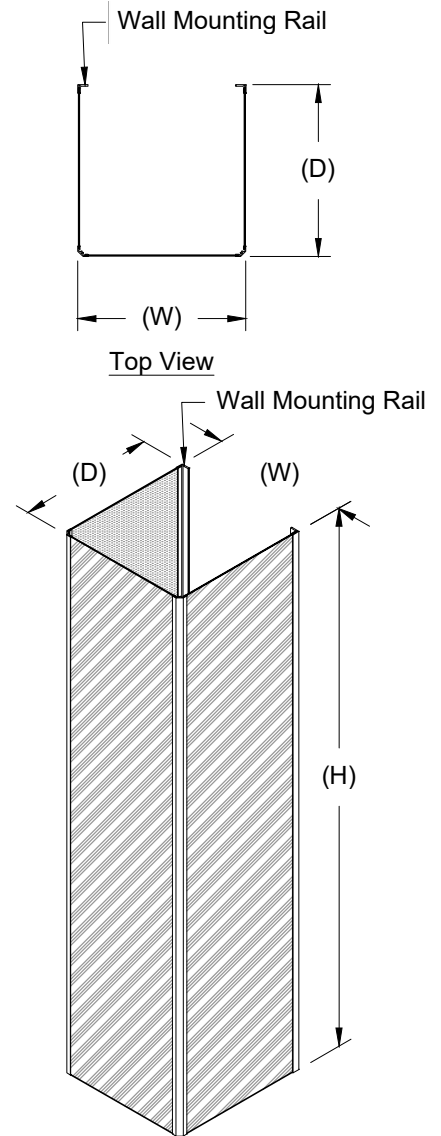

3D View

DD Rectangle			
Unit Size	Duct Cover Size		
Size	W	H	D
12 x 24 x 13	12	40	13
12 x 36 x 13	12	36	13
12 x 48 x 13	12	48	13
12 x 60 x 13	12	60	13
24 x 36 x 13	24	36	13
24 x 48 x 13	24	48	13
24 x 60 x 13	24	60	13
36 x 48 x 16	36	48	16
36 x 60 x 16	36	60	16
48 x 60 x 16	48	60	16

1. Available Finishes

Standard Finish:
01 White
Optional Finish
02 Satin Silver
03 Black
28 Custom Color

2. Available Accessories

3. Available Options

4. Construction Details

- 24ga. Steel Construction
- Max single section height of 48"
- Taller units will be made in multiple sections for structural rigidity

All Dimensions $\pm 1/16"$

Model: XG-DD-CU-DC Corner Unit - Duct Cover

XG-DD-CR-DC - Corner Unit - Duct Cover

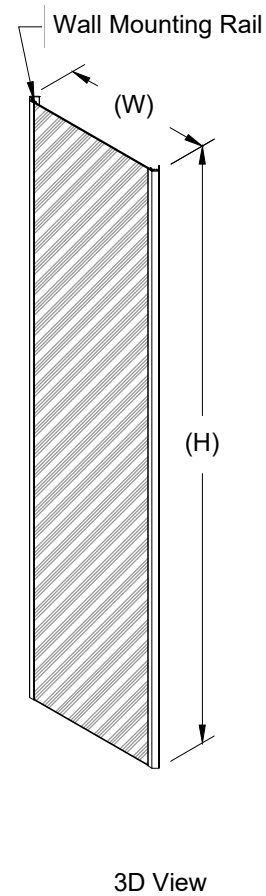
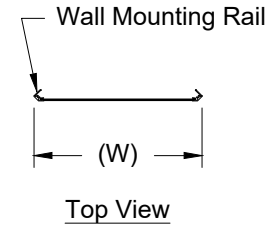
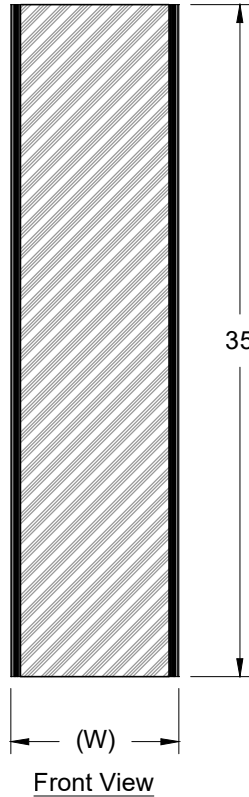

DD CU - Triangle Corner		
Unit Size	Duct Cover Size	
Size	W	H
12 x 24 x 6	12	24
12 x 24 x 6	12	36
12 x 24 x 6	12	48
12 x 24 x 6	12	60
24 x 36 x 12	24	36
24 x 36 x 12	24	48
24 x 36 x 12	24	60
36 x 48 x 18	36	48
36 x 48 x 18	36	60

1. Available Finishes	2. Available Accessories	3. Available Options	4. Construction Details
Standard Finish: 01 White Optional Finish 02 Satin Silver 03 Black 28 Custom Color			<ul style="list-style-type: none"> • 24ga. Steel Construction • Max single section height of 48" • Taller units will be made in multiple sections for structural rigidity

All Dimensions ±1/16"

Model: XG-DD-RD-90-DC Quarter Round 90° - Duct Cover

XG-DD-RD-90-DC - Quarter Round 90° - Duct Cover

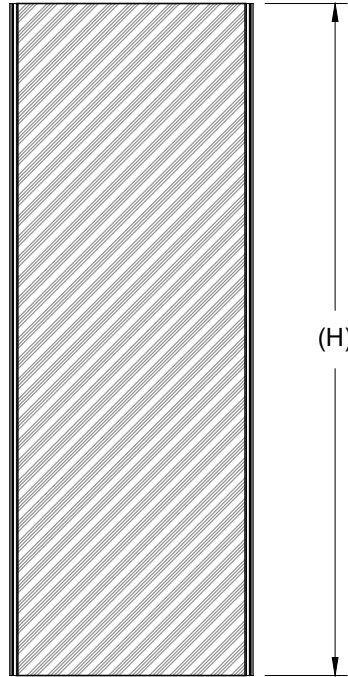

Front View

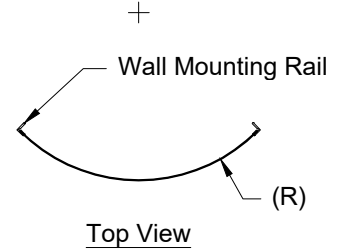

Top View

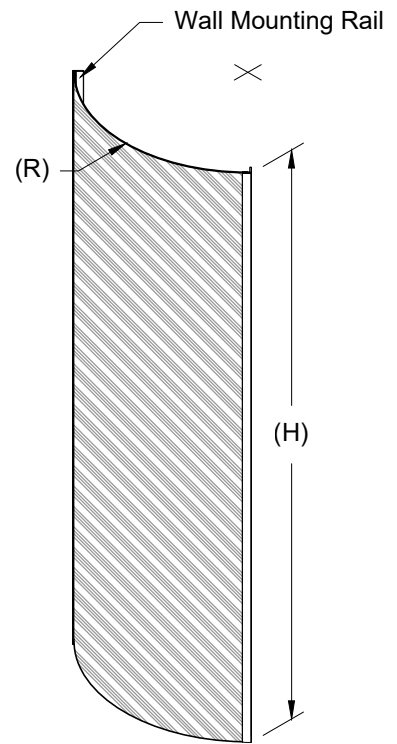

3D View

DD RD - 90°		
Unit Size	Duct Cover Size	
Size	Radius (R)	H
12 x 24	12	24
12 x 30	12	30
12 x 36	12	36
12 x 48	12	48
15 x 24	15	24
15 x 30	15	30
15 x 36	15	36
15 x 48	15	48
18 x 24	18	24
18 x 30	18	30
18 x 36	18	36
18 x 48	18	48
24 x 24	24	24
24 x 30	24	30
24 x 36	24	36
24 x 48	24	48

1. Available Finishes	2. Available Accessories	3. Available Options	4. Construction Details
Standard Finish: 01 White Optional Finish 02 Satin Silver 03 Black 28 Custom Color			<ul style="list-style-type: none"> • 24ga. Steel Construction • Max single section height of 48" • Taller units will be made in multiple sections for structural rigidity

All Dimensions ±1/16"

Model: XG-DD-RD-180-DC Semi Round 180° - Duct Cover

XG-DD-RD-180-DC - Semi Round 180° - Duct Cover

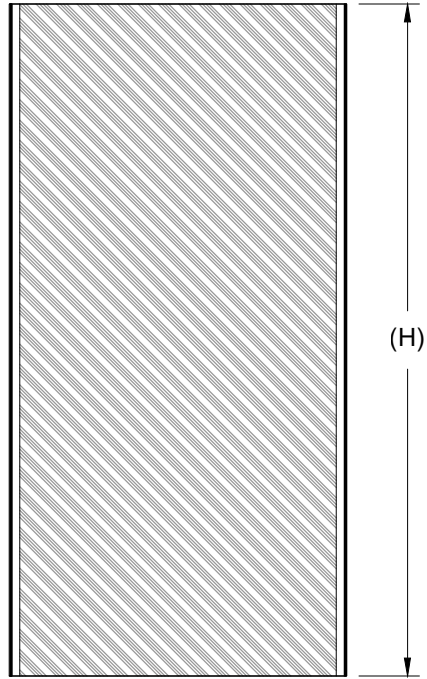

Front View

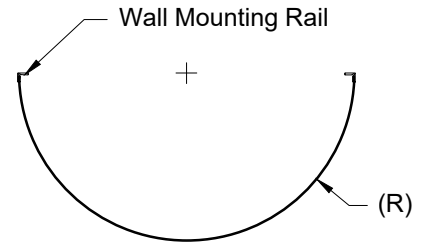

Top View

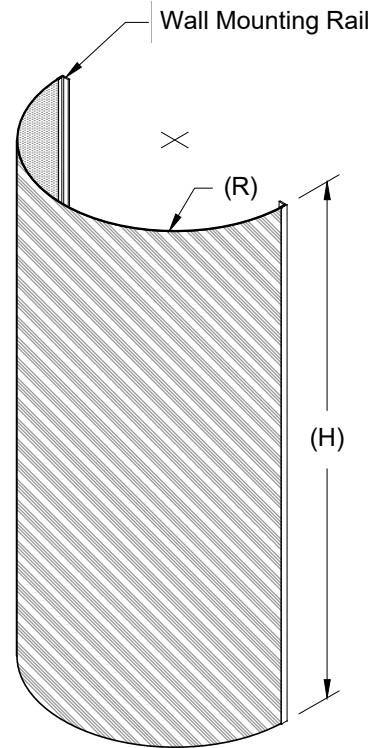

3D View

DD RD - 180°		
Unit Size	Duct Cover Size	
Size	Radius (R)	H
18 x 24 x 9	18	24
18 x 36 x 9	18	36
18 x 48 x 9	18	48
24 x 24 x 12	24	24
24 x 36 x 12	24	36
24 x 48 x 12	24	48
24 x 60 x 12	24	60
30 x 24 x 15	30	24
30 x 36 x 15	30	36
30 x 48 x 15	30	48
30 x 60 x 15	30	60
36 x 36 x 18	36	36
36 x 48 x 18	36	48
36 x 60 x 18	36	60

1. Available Finishes

Standard Finish:
01 White
Optional Finish
02 Satin Silver
03 Black
28 Custom Color

2. Available Accessories

3. Available Options

4. Construction Details

- 24ga. Steel Construction
- Max single section height of 48"
- Taller units will be made in multiple sections for structural rigidity

All Dimensions ±1/16"

Model: XG-DD-RD-360-DC Round 360° - Duct Cover

XG-DD-RD-360-DC - Round 360° - Duct Cover

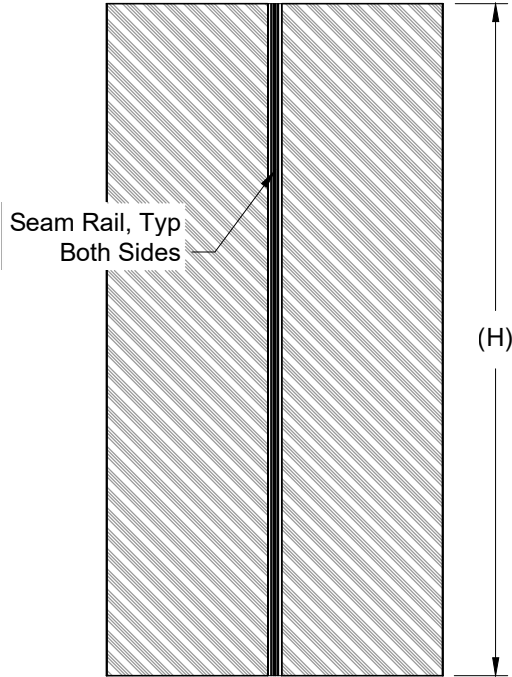

Side View

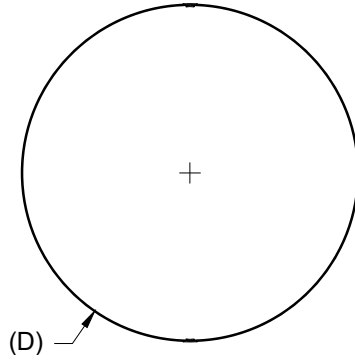

Top View

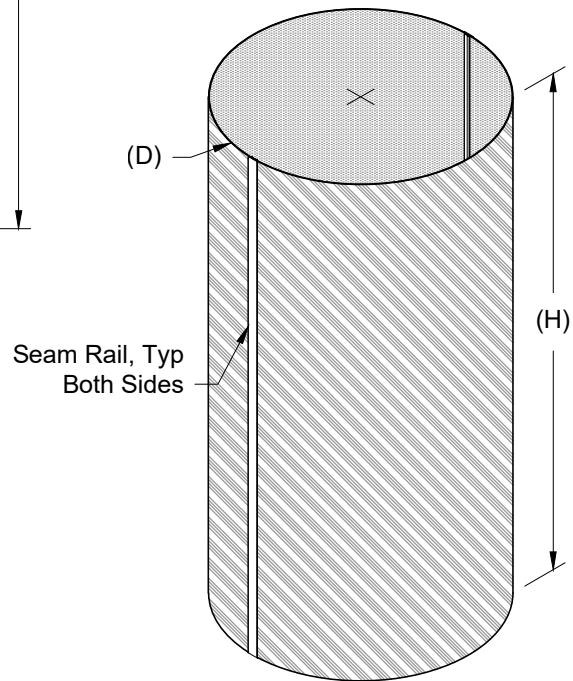

3D View

DD RD - 360°		
Unit Size	Duct Cover Size	
Size	Diameter (D)	H
18 x 18	18	24
18 x 36	18	36
18 x 48	18	48
24 x 24	24	24
24 x 36	24	36
24 x 48	24	48
24 x 60	24	60
30 x 24	30	24
30 x 36	30	36
30 x 48	30	48
30 x 60	30	60

1. Available Finishes

Standard Finish:
01 White
Optional Finish
02 Satin Silver
03 Black
28 Custom Color

2. Available Accessories

3. Available Options

4. Construction Details

- 24ga. Steel Construction
- Max single section height of 48"
- Taller units will be made in multiple sections for structural rigidity

All Dimensions ±1/16"