

SCH601MD

AMCA 540 and 550* Listed Hurricane Louver
Miami-Dade and Florida Product Approved
Extruded Aluminum | Storm Class
*AMCA 550 when selected with VCD-40 Damper

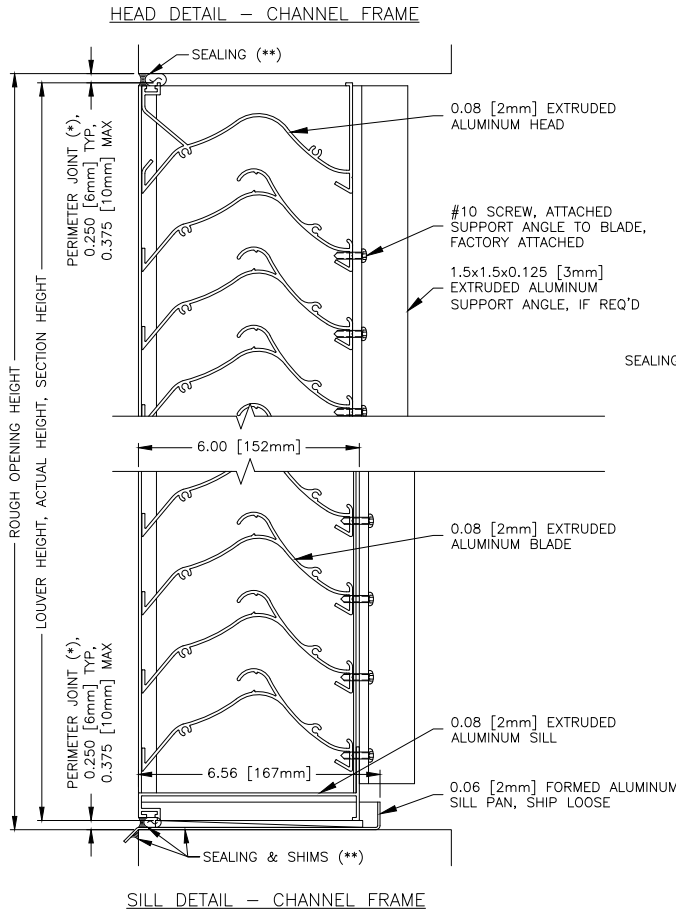

INVERTED MOUNTING ANGLE DETAILS – CHANNEL FRAME
OPTIONAL HEAD/SILL MOUNTING SETUP

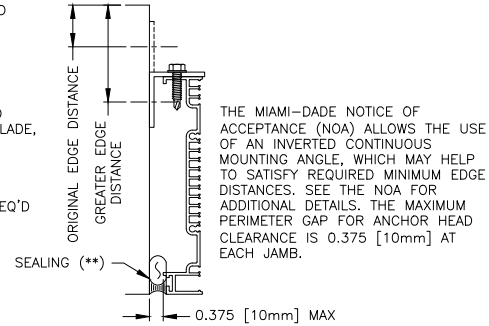

(*) TYPICAL VALUE IS THE STANDARD DOWNSIZING VALUE WHEN ORDERED BASED ON ROUGH OPENING, MAXIMUM VALUE IS THE MAXIMUM ALLOWED BY THE MIAMI-DADE NOTICE OF ACCEPTANCE (NOA).

(**) SEALING, NON-COMPRESSIBLE DEAD-LOAD SHIMS, SEPARATION OF DISSIMILAR MATERIALS ARE BY OTHERS. SEALANT IS REQUIRED AROUND EACH SECTION TO COMPLY WITH AMCA 550 HIGH VELOCITY WIND DRIVEN RAIN TEST. INSTALLER TO PROVIDE INTERMITTENT WEEPS BETWEEN LOUVER SILL AND SILL PAN.

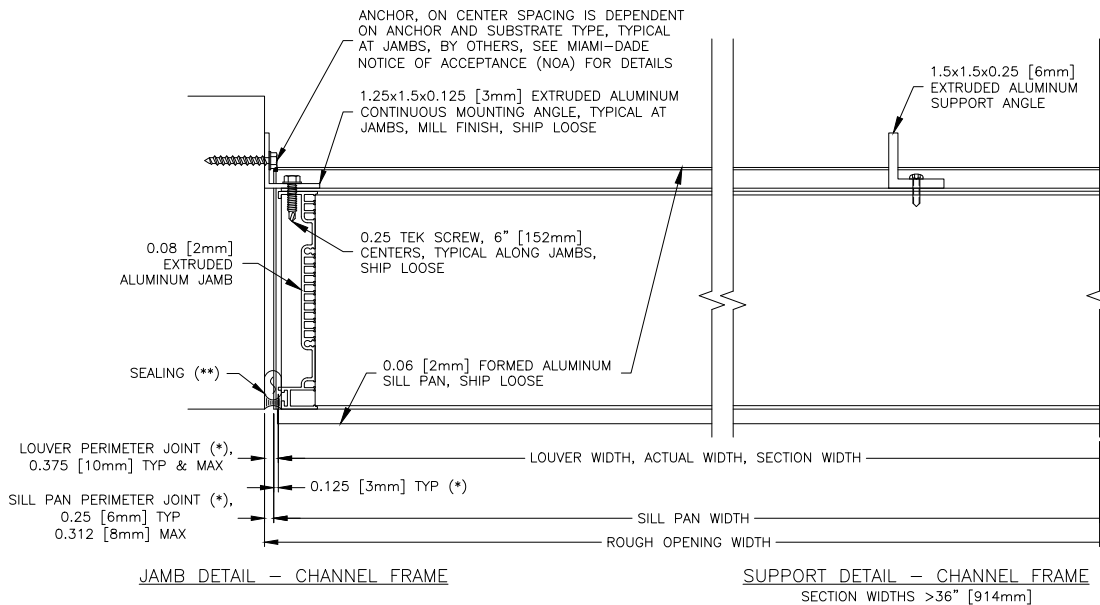

SCH601MD

AMCA 540 and 550* Listed Hurricane Louver
Miami-Dade and Florida Product Approved
Extruded Aluminum | Storm Class

*AMCA 550 when selected with VCD-40 Damper

MULLION HEAD DETAIL — CHANNEL FRAME
R.O. HEIGHTS ≤96.5" [2451mm]

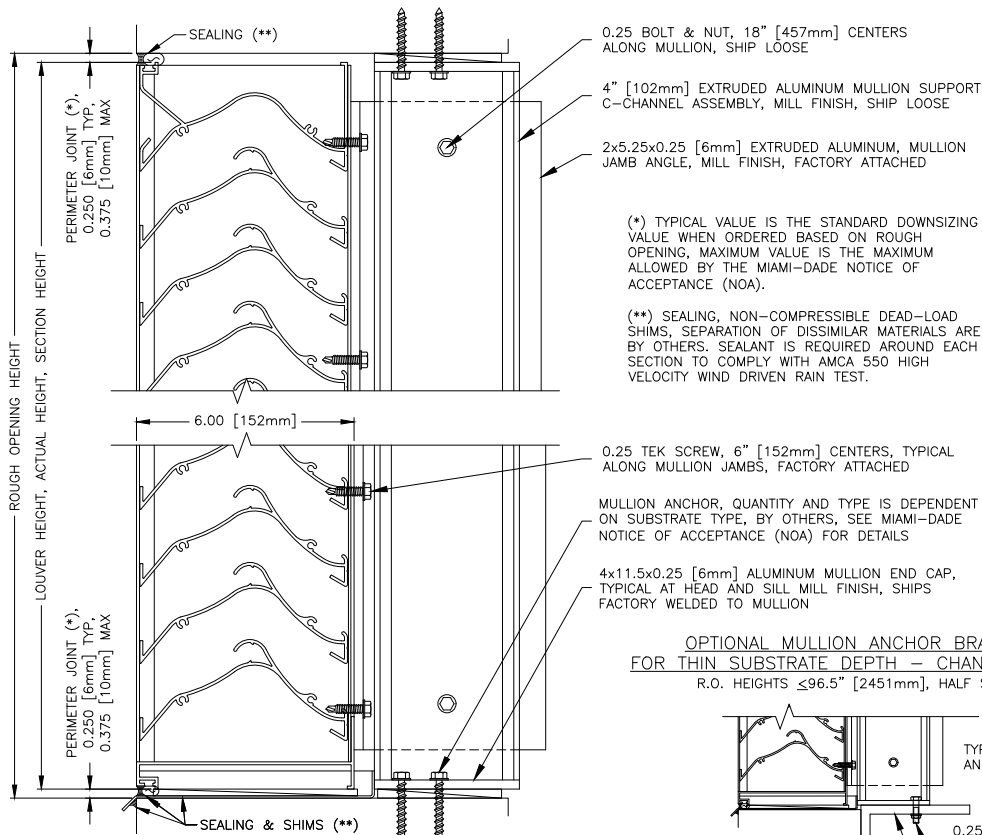

OPTIONAL MULLION ANCHOR BRACKET FOR THIN SUBSTRATE DEPTH — CHANNEL FRAME
R.O. HEIGHTS ≤96.5" [2451mm], HALF SCALE

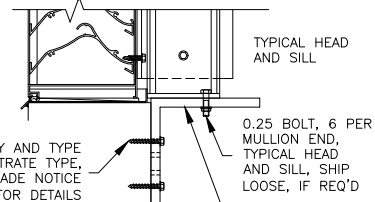

MULLION SILL DETAIL — CHANNEL FRAME
R.O. HEIGHTS ≤96.5" [2451mm]

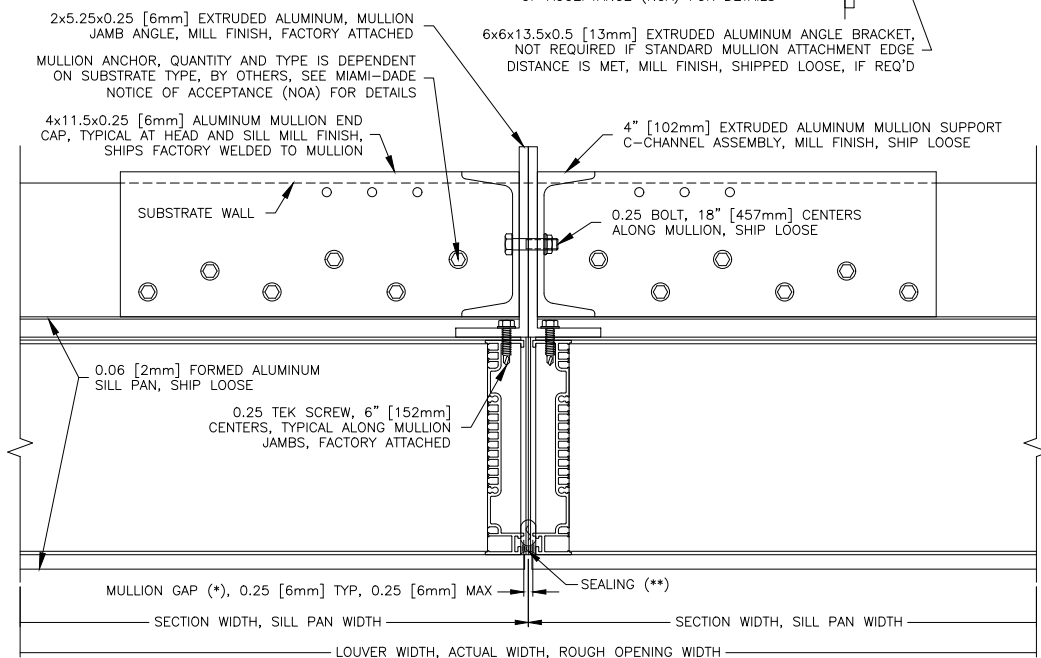

MULLION DETAIL — CHANNEL FRAME
R.O. HEIGHTS ≤96.5" [2451mm]

AIROLITE
The look that works.™

SCH601MD

AMCA 540 and 550* Listed Hurricane Louver
Miami-Dade and Florida Product Approved
Extruded Aluminum | Storm Class
*AMCA 550 when selected with VCD-40 Damper

MULLION HEAD DETAIL — CHANNEL FRAME
R.O. HEIGHTS >96.5" [2451mm]

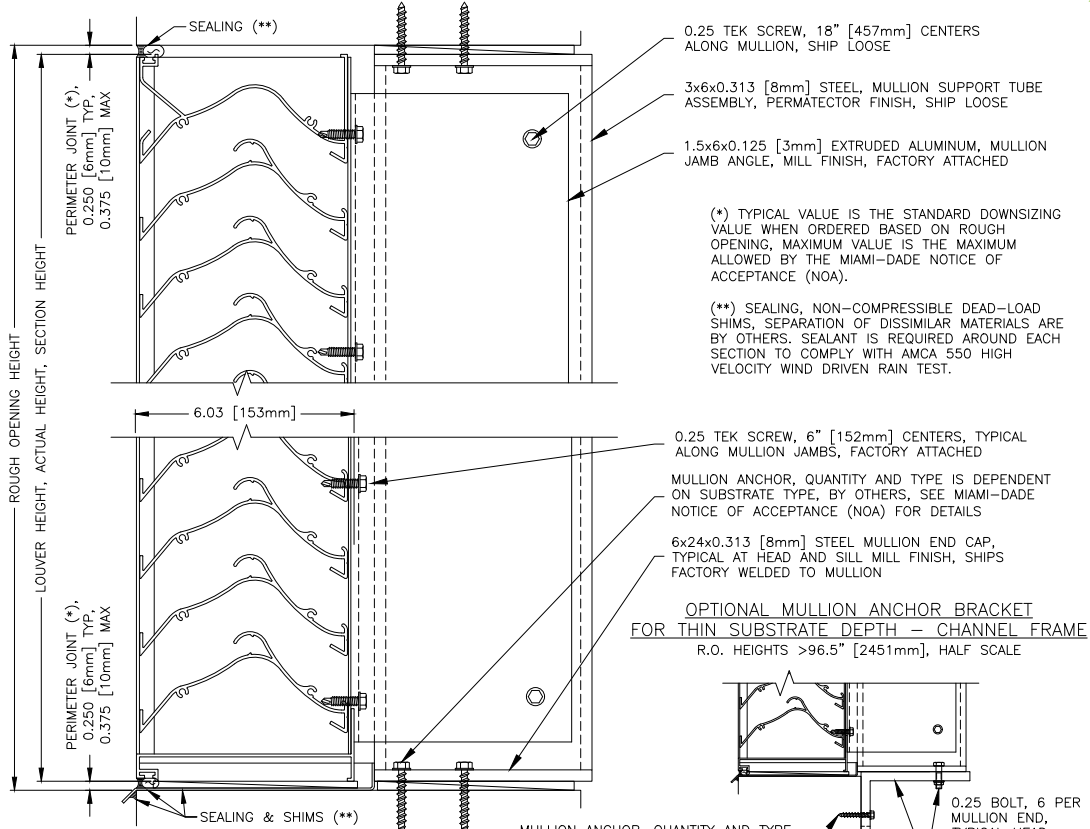

MULLION SILL DETAIL — CHANNEL FRAME
R.O. HEIGHTS >96.5" [2451mm]

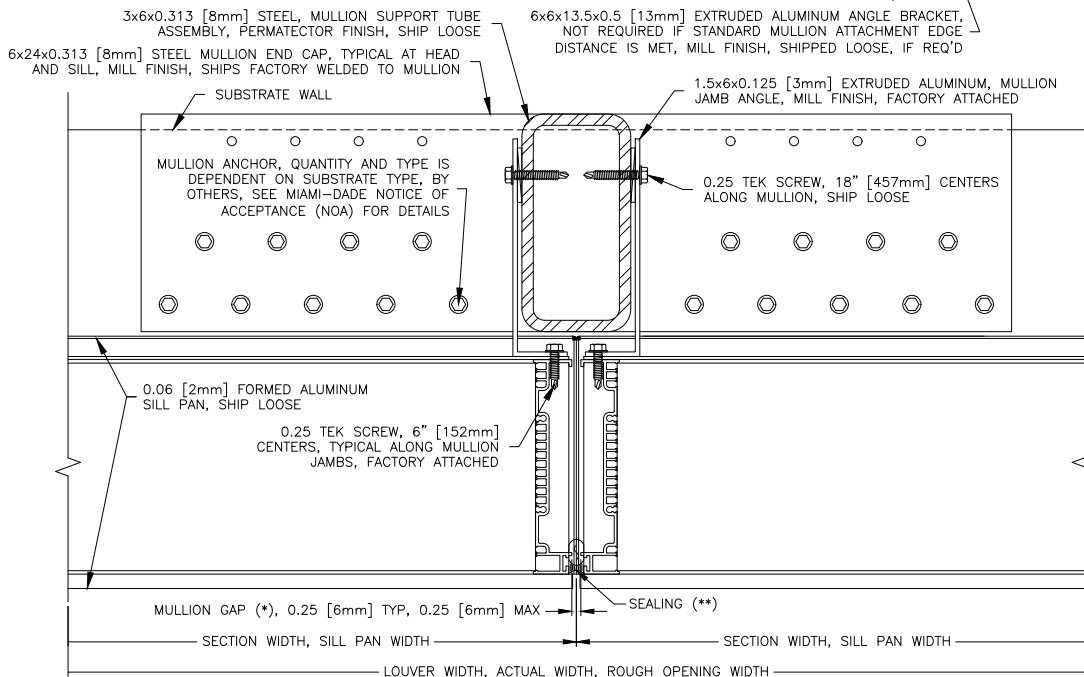

MULLION DETAIL — CHANNEL FRAME
R.O. HEIGHTS >96.5" [2451mm]

AIROLITE
The look that works.™