



Product Features:

- 4 Cone Ceiling Diffuser
- 360 Degree throw pattern
- Architectural design with pleasing aesthetic
- Excellent pressure and noise performance
- Available in steel and aluminum
- Fit multiple t-bar grid modules
- Available Neck Sizes: 6, 8, 10, 12, 14 and 15 inch
- Unique border styles available for various applications

Finishes





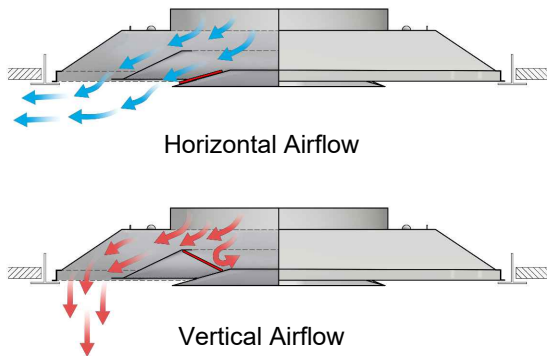

01 - White ¹ 	03 - Black 
02 - Satin Silver 	28 - Wood Grain * 
28 - Custom Color 	* Wood Grain Finish Available on Request

¹ White Finish is suitable for a primer coat if field painting is required.

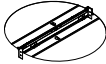
Throw Pattern Visualization

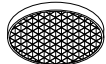
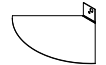

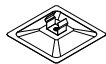
Optional Accessories:

-  BDS - Butterfly Damper
-  RSD - Radial Shutter Damper
-  G3 - Equalizing Grid
-  BAF - Directional Baffles
-  TBPF - T-Bar Plaster Frame
-  EQS - Earthquake Straps
-  4C - Fourth Cone
-  FGBP - Fiberglass Backpan
-  2"BC - 2" Beaded Inlet Collar

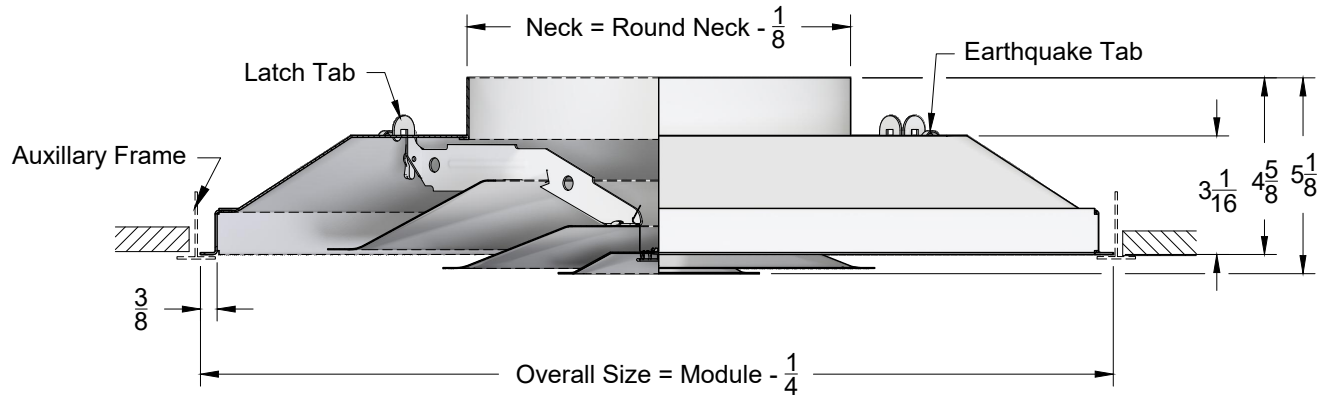

Module Size
24 x 24
12 x 12

Face View

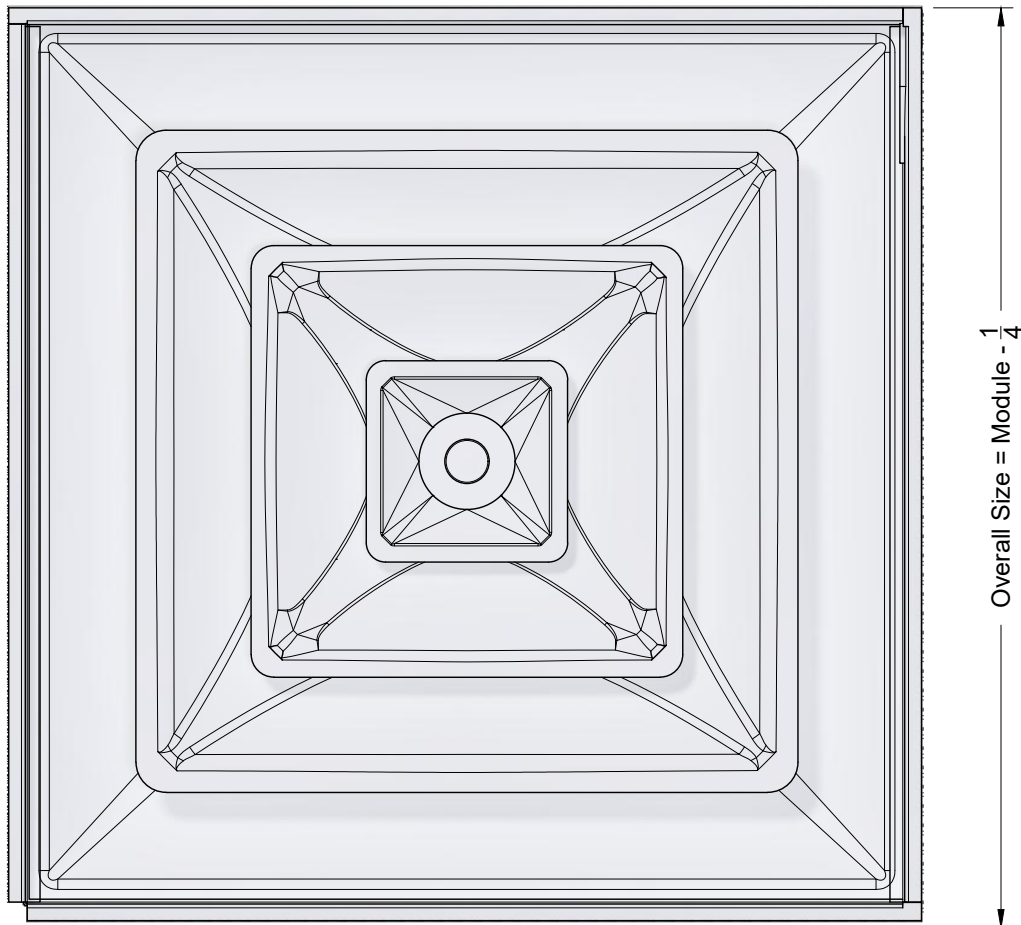

Note: For surface mount installations, use of plaster frame is recommended

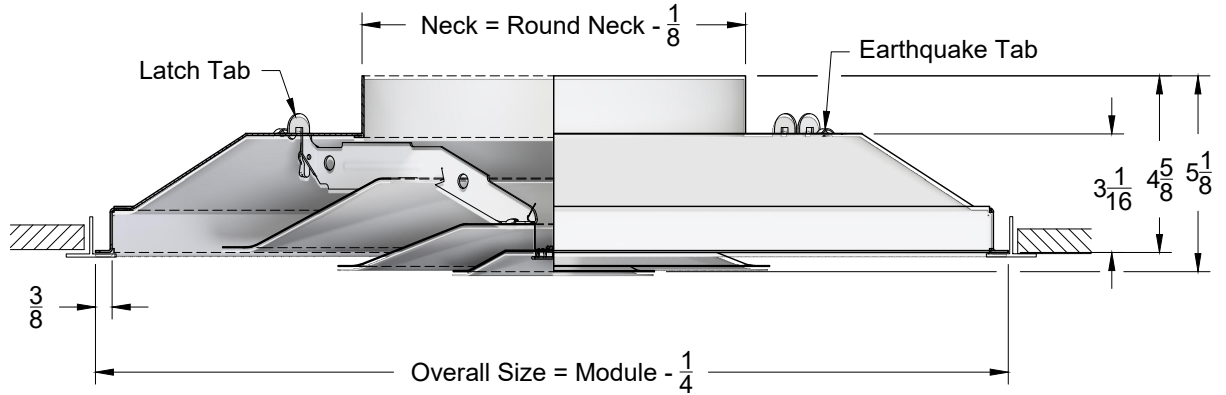

Module Size
24 x 24
12 x 12

Face View

