

Reference Guide for Microprocessor Controller

Please read and save these instructions for future reference. Read carefully before attempting to assemble, install, operate or maintain the product described. Protect yourself and others by observing all safety information. Failure to comply with these instructions will result in voiding of the product warranty and may result in personal injury and/or property damage.

MUA v4.1
Version date 12/24



Technical Support
Call 1-800-240-0870

Introduction

Program Features

The microprocessor controller offers control through easy monitoring and adjustment of unit parameters by way of a lighted graphical display and an integral push-button keypad.

Pre-Programmed Operating Sequences

The controller has been pre-programmed to offer multiple control sequences to provide tempered air. Factory default settings allow for easy setup and commissioning. The sequence parameters are fully adjustable. Refer to the Sequence of Operation for details.

BMS Communication

The user can remotely adjust setpoints, view unit status points and alarms. The microprocessor controller is capable of communicating over several protocols:

- BACnet® MSTP
- Modbus RTU
- BACnet® IP
- Modbus TCP

Reference Points List for a complete list of BMS points.

Built-In Occupancy Schedule

The controller has an internal programmable time clock, allowing the user to set occupancy schedules for each day of the week. The controller option also has morning warm-up and cool down capability for improved comfort at the time of occupancy.

Alarm Management

The microprocessor controller will monitor the unit's status for alarm conditions. Upon detecting an alarm, the controller will record the alarm description, time, date, and input/output status points for user review. Alarms are also communicated via BMS (if equipped).

Occupancy Modes

The microprocessor controller offers three modes of determining occupancy: a digital input, occupancy schedule or the BMS. If in the unoccupied mode, the unit will either be shut down, continue normal operation utilizing adjustable unoccupied setpoints, recirculate with unoccupied setpoints or will cycle on to maintain adjustable unoccupied space temperature setpoints (space temperature sensor is optional).

Remote Unit Access (if equipped)

The WebUI and Remote Display are two ways to gain access to the unit controller allowing monitoring of the unit and parameter adjustment without being at the unit.

The WebUI can be accessed via a building network and is included with every unit controller. The Remote Display is an LCD to be panel mounted in a remote location and is an option available for purchase.

WARNING

For A2L appliance only. LEAK DETECTION SYSTEM installed. Unit must be powered except for service.

WARNING

Electrical shock hazard. Can cause personal injury or equipment damage. Service must be performed only by personnel that are knowledgeable in the operation of the equipment being controlled.

WARNING

Mechanical high static protection cutoffs must be installed by others to protect the system and equipment from over-pressurization when using factory provided control sensors. The manufacturer does not assume responsibility for this.

Table of Contents

Sequence of Operation	3
Display Use	7
Parameter Adjustment	7
Main Menu	8
Unit Status Overview	9
Unit Enable	12
Menu	
Unit Enable	12
Control Variables	
Temp Control	12
Heat & Vent	15
Evap Cooling	15
Damper Control	16
Supply Fan Control	17
Exhaust Fan Control	18
Occupancy	18
Advanced	19
Manual Overrides	19
Advanced Setpoints	21
Network Settings	22
Backup/Restore	23
I/O Configuration Menu	25
Unit Config	25
Commissioning	25
Alarms	25
Appendix	
A: Remote Display	27
B: I/O Expansion Board Quick Start	28
C: Space Thermostat Quick Start	29
D: Touchscreen	31
E: Points List	36
F: Factory ModBus Connections	46
G: NTC Temperature Sensor Chart	46
H: Refrigerant Leak Detection System	47
Our Commitment	Backcover



The microprocessor controller can be configured for air handler, energy recovery, and dedicated outdoor air systems. Each application utilizes similar technologies for heating and cooling: chilled water, hot water, indirect gas, electric heat, direct gas, evaporative cooling and packaged or split DX cooling. All setpoints, lockouts and delays are user adjustable via the integral keypad display, remote display, or web user interface.

General Operation

UNIT/SYSTEM DISABLED COMMAND:

The unit becomes disabled due to the following:

- The unit was disabled from the controller's Unit Enable screen.
- The unit was disabled from the BMS.
- The remote start input is in the off position.
- The shutdown input is in the shutdown position.
- A system shutdown alarm was activated.
- Fire safety shutdown alarm was activated.

UNIT START COMMAND: The microprocessor controller requires a digital input to enable operation.

The unit can then be commanded on or off by this digital input, keypad, the BMS or schedule. When a start command becomes active the following steps occur:

- Factory mounted and wired dampers are powered (Outside air, and recirculation air dampers, if equipped)
- Exhaust if equipped, starts after adjustable delay
- Supply fan starts after adjustable delay
- Tempering operation starts after adjustable delay

UNIT STOP COMMAND: A shutdown occurs when there is not an occupied or unoccupied start command. The following shutdown methods can occur.

Hard shutdown occurs under the following conditions:

- A user or the BMS disables the system, and the supply temperature is less than the soft shutdown enable setpoint.
- Occupancy is commanded to unoccupied while there is no unoccupied start command, and the supply temperature is less than the soft shutdown enable setpoint.

When a hard shutdown occurs:

- The unit shuts down immediately.
- Dampers spring-return to their off position. Damper power is cut 30 sec. after the fans. This allows the fans to slow down prior to spring closing the dampers.

Soft shutdown occurs under the following conditions:

- A user or the BMS disables the system, and the supply temperature is greater than or equal to the soft shutdown enable setpoint.
- There is no unoccupied or occupied start command and the supply temperature is greater than or equal to the soft shutdown enable setpoint.

The following occurs during a soft shutdown:

- Tempering outputs immediately revert back to their off value; while
- Dampers remain open and fans continue to run; until
 - The supply air temperature falls below the soft shutdown enable setpoint minus 5.0°F; or
 - The soft shutdown delay timer has expired.

OCCUPANCY: The microprocessor controller offers five modes of determining occupancy: digital input, occupancy schedule, BMS, always occupied, or always unoccupied. When in the unoccupied mode, the unit can be configured to shut down, or cycle on to maintain the unoccupied space setpoints. The unit can be temporarily overridden to the occupied mode via a digital input, keypad display, or space thermostat, if equipped.

• Occupied Mode:

- Damper Control (refer to Outside Air and Recirculated Air section), if equipped
- Exhaust on, if equipped
- Supply fan on
- Tempering operations begin

• Unoccupied Mode:

- **Unit Off:** Unit remains off when in unoccupied mode.
- **Normal operation with unoccupied setpoints:** Unoccupied mode will operate as if in occupied mode but will utilize adjustable unoccupied setpoints.
 - Damper Control (refer to Outside Air and Recirculated Air section), if equipped
 - Exhaust on, if equipped
 - Supply fan on
 - Tempering operations begin
- **Recirculation with unoccupied setpoints:** Unoccupied mode will operate using adjustable unoccupied set points when a recirculation damper is available.
 - Supply fan on
 - Recirculation air damper open
 - OA damper opens to unoccupied minimum position
 - Tempering operations begin
- **Night Setback:** Unoccupied mode when there is space temperature sensor connected to the controller. The unit will cycle on to maintain unoccupied space setpoints if there is a call for unoccupied heating or cooling.
 - Exhaust off, if equipped
 - Recirculation air damper open
 - OA damper opens to unoccupied minimum position
 - Supply fan on
 - Tempering operations begin

- **Morning Warm-Up/Cool Down:** At the request to occupy the space, the unit will run using the warm-up or cool down sequence until the occupied setpoint is achieved. The heating or cooling mode must not be locked out and the space temperature is below or above setpoint by the unoccupied hysteresis (5°F, adj). This optional sequence requires a space temperature sensor and is field-enabled.

The following steps occur during a morning warm-up/cool down:

- The dampers would be in full recirc if the damper actuators are not powered (adj) during unoccupied mode. Otherwise the following is true:
 - Outside air damper is open to unoccupied minimum OAD position.
 - Recirculation air damper is open at 100% minus OAD position.
- Supply Fan is ON at 100%.
- Exhaust is OFF.
- In heating, controls to maintain the maximum supply setpoint (100°F).
- In cooling, controls to the minimum supply setpoint (50°F).

Setpoint Control (Continuous)

When the unit is running continuously, the supply air temperature setpoint can be configured as a constant value or reset by either outside air temperature, space temperature, or return temperature. Supply air temperature reset modes can be set for both occupied and unoccupied operation in the controller. If equipped with BMS communications, the BMS system can also directly command the temperature setpoint.

- **Outside Air Temperature Reset:** The controller will adjust the supply air temperature setpoint based on the OA temperature between the min (55°F) and max (70°F). The min and max setpoints can be locally adjusted at the microprocessor for the outside temperatures and the supply air temperature min and max.
- **Space Temperature Reset:** The controller will adjust the supply air temperature setpoint between the min (55°F) and max (90°F clg/ 100°F htg) to satisfy the desired occupied or unoccupied space temperature setpoints with a valid space temperature reading. The space temperature setpoint for occupied and unoccupied mode can be adjusted locally at the microprocessor or the BMS. Occupied temperature setpoints can be adjusted at the space thermostat.
- **Return Temperature Reset:** The controller will adjust the supply air temperature setpoint between the min (55°F) and max (90°F clg/ 100°F htg) to satisfy the desired occupied or unoccupied return temperature setpoint with a valid return temperature reading. The return temperature setpoint can be adjusted locally at the microprocessor or the BMS.

Setpoint Control (Night Setback)

When the unit is set to cycle on space temperature in night setback, the supply air temperature is automatically set using the following strategy:

- **Heating:** The unit is enabled when the space temperature is less than the unoccupied heating setpoint (65°F). The unit cycles off when the space temperature increases above the unoccupied heating setpoint by the hysteresis amount (5°F). During this time, the supply air temperature setpoint is set to the supply max reset limit (100°F).
- **Cooling:** The unit is enabled when the space temperature is greater than the unoccupied cooling setpoint (80°F). The unit cycles off when the space temperature decreases below the unoccupied cooling setpoint by the hysteresis amount (5°F). During this time, the supply air temperature setpoint is set to the supply min reset limit (55°F).

Heating

The heating is controlled to maintain the supply temperature setpoint. The heating will be locked out when the outside air temperature is above the heating lockout (65°F adj).

- **Direct Gas Heating:** Microprocessor controller will modulate the direct gas burner to maintain the supply temperature setpoint.
- **Indirect Gas Furnace:** Microprocessor controller will modulate the indirect gas furnace to maintain the supply temperature setpoint.
- **Hot Water:** Microprocessor controller will modulate a hot water valve (provided by others) to maintain the supply temperature setpoint. **Coil freeze protection must be provided by others in the field!**
- **Electric Heater:** Microprocessor controller will modulate an electric heater to maintain the supply temperature setpoint.

Cooling

The cooling is controlled to maintain the supply temperature setpoint. The cooling will be locked out when the outside air temperature is below the cooling lockout (75°F).

- **Chilled Water:** Microprocessor controller will modulate a chilled water valve (provided by others) to maintain supply air setpoint. **Coil freeze protection must be provided by others in the field!**
- **Mechanical Cooling:** Microprocessor controller enables stages of cooling to maintain the supply air setpoint. Mechanical cooling is available in the following configurations:

Sequence of Operation

- **Packaged DX:** Unit with compressors and condensing section located within the same unit.
- **Evaporative Cooling:** Microprocessor will enable the evaporative cooling when the outside air is above the cooling lockout setpoint (80°F). The valves will be energized opening the supply valve and closing the drain and supply line drain valves for an adjustable delay prior to the pump being enabled. The auto drain flush sequence can be used to drain the sump after an adjustable amount of run-time to bring fresh water into the evaporative cooler.

Economizer

If the application requires cooling, and the OA conditions are suitable for free cooling, the controller will enter economizer mode. If the unit is economizing and the discharge temperature setpoint is not being met, the controller will bring on mechanical cooling. If equipped with a modulating OA and recirculated air damper, the dampers will modulate between the min OA and max positions to maintain the supply temperature setpoint.

- **Temperature:** The economizer will be locked out when:
 - The outside air less than the economizer minimum lockout (40°F) and greater than the economizer maximum lockout (65°F).
 - There is a call for heating.

Supply Fan VFD Sequence

The factory installed VFD is wired to the controller. Supply fan speed needs to be set during test and balance of the unit. If equipped with BMS communications, the user can also directly command the supply fan speed. The following sequences are selectable for supply fan control. The fan speed is constrained by its min and max speed setpoints.

- **Constant Volume:** Supply fan operates at a constant speed based on a constant volume setpoint based on occupancy.
- **0-10 VDC:** The supply fan is enabled by the unit controller. An external field-supplied 0-10 VDC signal is responsible for modulating the supply fan's speed.
- **CO₂ Control:** The supply fan modulates to maintain CO₂ setpoint based on a sensor located in the space or return duct. A CO₂ sensor or BMS communicated value is required for this sequence.
- **Duct Static Pressure:** The supply fan modulates to maintain an adjustable duct static setpoint based on a sensor located in the supply duct. A static pressure sensor or BMS communicated value is required for this sequence.
- **Space Static Pressure:** The supply fan modulates to maintain a space static pressure setpoint based on a sensor located in the space. A space static pressure sensor or BMS communicated value is required for this sequence.

- **Two Speed:** The supply fan is enabled by the unit controller. An external field-supplied digital contact is responsible for enabling high speed operation. The supply fan min (50% and max (100%) speeds are used for low and high speed settings.

Exhaust Sequence

- **Exhaust Enable with Proving:** A dry contact can be configured to signal an exhaust fan to start when the supply fan is running. Microprocessor controller monitors exhaust fan proving input and displays an alarm in case of the exhaust fan not being proven.
- **Exhaust Relief Contact (Heat and Ventilation):** A dry contact can be configured to signal an exhaust fan to start or a relief damper to open when the supply fan is running. This can be configured to be enabled always (default), occupied mode only, unoccupied mode only, or never (this is adjustable for both summer and winter modes).

Outside Air and Recirculated (Recirc) Air Damper Control

If equipped with a modulating OA and recirculated air damper, the recirculated air damper will operate inverse of the OA damper. The OA damper opens to its min position. If the controller is configured to modulate the supply fan speed, the min and max OA positions can be reset based on supply fan speed. If equipped with BMS communications, the BMS can directly control the outside damper position. The damper position is constrained by its min and max setpoint positions.

- **CO₂ Control:** The controller will proportionally modulate the OA/RA dampers based upon a comparison of the CO₂ setpoint to the actual CO₂ level reported from the sensor. As the CO₂ level rises, the controller will proportionally modulate the OA damper open, between the min OA damper position and max CO₂ position.
- **Space Static Pressure:** The OA/RA dampers will modulate based upon the signal from a building static pressure sensor. The controller will modulate the dampers, between the min and max OA positions, based upon a comparison of the building static pressure setpoint to the actual building static pressure level reported from the sensor.
- **0-10 by Others:** An external field supplied 0-10 VDC signal is responsible for setting the damper position.
- **Two Position:** An external field supplied digital contact is responsible for setting the damper to max position. The OA Damper min (30%) and max (100%) positions are used for the low and high position settings.

A2L Refrigerant Leak Mitigation

Packaged cooling units are equipped with two refrigerant leak detection sensors - one in the airstream and the other in the compressor cabinet.

- **Refrigerant leak detected:** Compressors are disabled, unit is set to occupied mode, and damper is opened and supply fan speed is adjusted. If the unit is equipped with direct gas heat, the heat will be disabled. When the alarm clears, the unit returns to normal operation.
- **Fire safety shutdown alarm is triggered:** Unit is disabled, and refrigerant leak alarms are ignored. When the alarm clears, the unit returns to normal operation.

Reference Appendix: Refrigerant Leak Detection System for additional information.

Heating and Ventilating Mode

This mode is an alternative sequence of operation designed for heating and ventilating applications. Heating and ventilating mode has 2 modes of operation, summer mode and winter mode.

- **Changeover:** The microprocessor controller switches between summer and winter mode automatically (auto-changeover) or it can be commanded locally or by the BMS (if equipped).
 - **Auto-changeover (default):** The microprocessor shall switch to winter mode when the space temperature is below the change-over temp (65°F adj). When space temperature rises above the change-over temp + differential (65°F + 15°F adj), the microprocessor shall switch to summer mode.
 - **Manual:** The user will command the unit into summer or winter mode using the keypad or through the BMS (if equipped).
 - **Summer lockout:** Summer mode will be locked out and the unit will be locked into winter mode if the outside air temperature falls below the summer outdoor lockout setpoint (55°F adj).
- **Winter Mode:** In the winter mode the unit can be configured to operate continuously, cycle on a call for heating or can be disabled (adjustable for both occupied and unoccupied modes). If equipped with modulating OA and recirculated air dampers, the dampers shall be positioned to the winter setpoint (adjustable for both occupied and unoccupied modes).
 - **Continuous:** The supply fan shall run continuously for ventilation. Heating will be enabled when the outside air temperature is above the heating lockout setpoint. The heating device will modulate to maintain the supply temperature setpoint. The supply temperature setpoint is reset by space temperature (see section Setpoint Control (Occupied)).
 - **Cycle:** The supply fan and heating will cycle on

when space temperature falls below the room temperature setpoint minus differential. The supply temperature setpoint will be set to the supply max reset limit. The unit cycles off when the space temperature reaches the unoccupied heating setpoint.

- **Off:** The unit shall be disabled.
- **Summer Mode:** In the summer mode the unit can be configured to operate continuously, or can be disabled (adjustable for both occupied and unoccupied modes). If equipped with modulating OA and recirculated air dampers, the dampers shall be positioned to the summer setpoint (adjustable for both occupied and unoccupied modes).
 - **Continuous:** The supply fan shall run continuously for ventilation. Heating will be locked out.
 - **Off:** The unit shall be disabled.
- **Exhaust Relief Contact:** A dry contact can be configured to signal an exhaust fan to start or a relief damper to open when the supply fan is running. This can be configured to be enabled always (default), occupied mode only, unoccupied mode only, or never (this is adjustable for both summer and winter modes).







Alarms

The microprocessor controller monitors alarms and will alarm on the following conditions:

- **Dirty Filter Alarm:** If the outside air or return air filter differential pressure rises above the differential pressure switch setpoint, the microprocessor controller will activate an alarm.
- **Supply and Exhaust Air Proving Alarm:** Microprocessor controller monitors fan proving on each blower and displays an alarm in case of blower failure.
- **Supply Air Flow Limit:** If the supply air temperature drops below supply air low limits (35°F), the controller disables the unit and activates the alarm after preset time delay (300/ Sec).
- **Sensor Alarm:** Microprocessor controller will send an alarm if a failed sensor is detected (temperature, pressure, relative humidity).
- **Fire Safety Shutdown Alarm:** If the fire shutdown input is triggered, the controller disables the unit and activates the alarm output.
- **Refrigerant Leak Alarm:** If a refrigerant leak is detected without an active Fire Safety Shutdown alarm, the controller will: activate an alarm, enable the unit, disable compressors, ignore supply air temperature alarms, open dampers and override supply fan speed. If the unit is equipped with direct gas heat, the heat will be disabled.
- **Other Alarms:** High/Low Refrigerant Pressure

Display Use

The microprocessor controller is located in the unit control center. The face of the controller has six buttons, allowing the user to view unit conditions and alter parameters. The microprocessor controller is pre-programmed with easy to use menus. A remote display is also available.



Keypad Description		
Button	Description	Functions
	Main Menu	Press to go directly to the Main Menu from any screen. From the Main Menu, navigate to the following screens: <ul style="list-style-type: none"> • Unit Enable • Unit Status • Ctrl Variables • Alarm Menu
	Alarm	The Alarm button flashes when there is an active alarm. Press to view alarms. Press twice to go to the alarms reset screen.
	Escape	Press from the Main Menu to view the Unit Status screen. Press to go back one menu level.
	Up	Press to navigate through the menus/screens. Press after entering a variable to increase a current value.
	Enter	Press to enter a highlighted menu or screen item. Press to enter a writable variable and press again to confirm the new variable value.
	Down	Press to navigate menus/screens. Press after entering a variable to decrease the current value.

Parameter Adjustment



The cursor always begins in the upper left corner of the display and will be blinking. Press the  button to move the cursor down for parameter adjustment.



Once the cursor has reached the desired parameter, press the   buttons to adjust the value.





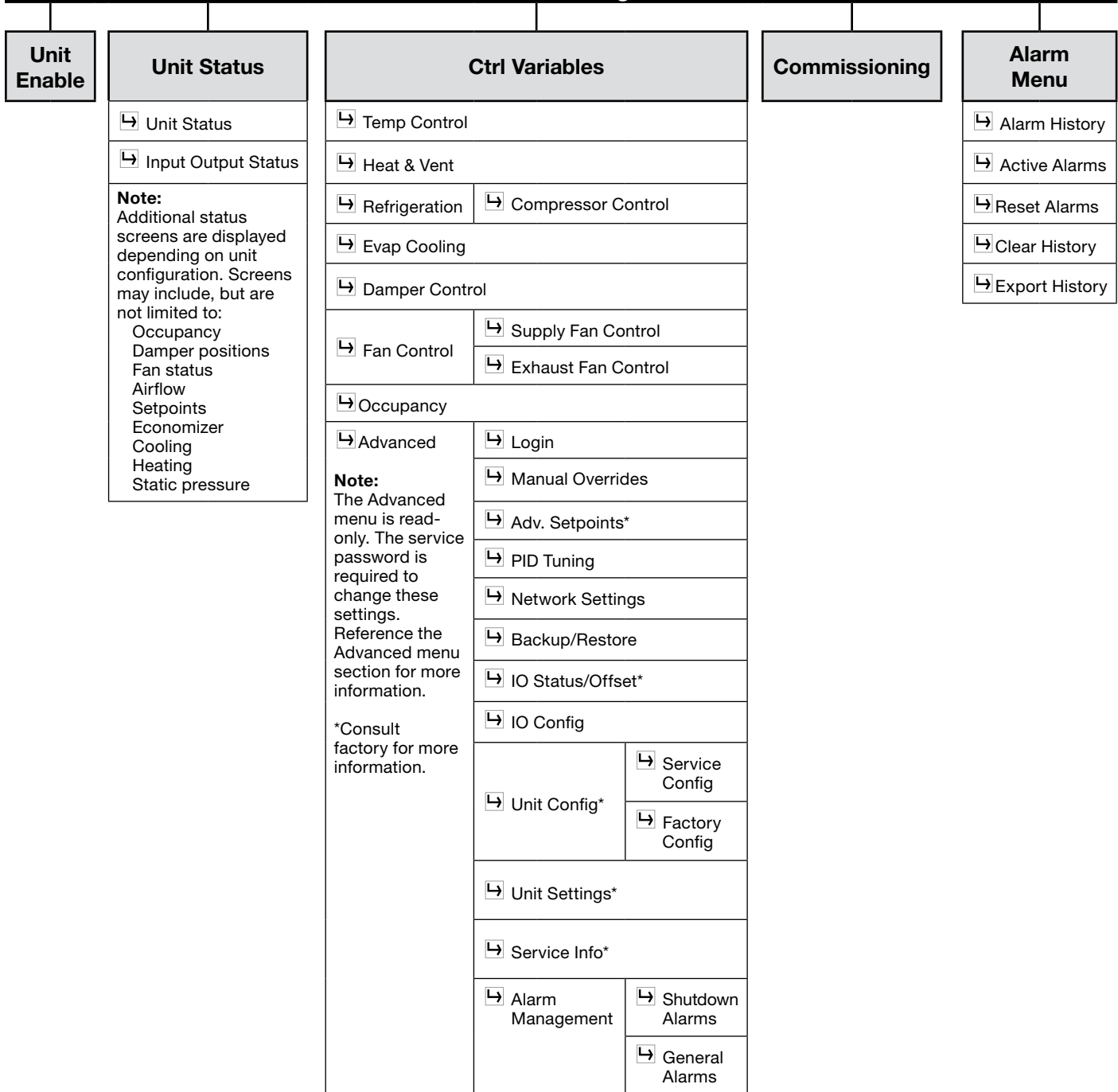

When satisfied with the adjustment, press the  button to save the parameter. When finished, make certain the cursor is in the upper left corner. If the cursor is not in the upper left corner, the changes will not be saved. The cursor must be in the upper left corner to enable screen advancement.

Main Menu Navigation



Unit Status Overview

The microprocessor controller will revert to a default main menu loop. This loop includes several screens to view the operating conditions of the unit. Scroll through the menu screens by using the   buttons.





1 Active Alarm(s)	
SUPPLY 65°F	OUTSIDE 60°F
SUPPLY SETPOINT 70°F	 
System On	

THE INITIAL MENU SCREEN DISPLAYS THE JOB NAME, UNIT TAG, UNIT STATUS, OUTSIDE AIR CONDITIONS, SPACE CONDITIONS AND SETPOINTS.

Possible modes include:

- Standby
- Unoccupied Start
- Dampers Open
- Occupied Start
- Opening Dampers
- Fan Start Delay
- Exhaust Fan Start
- Supply Fan Start
- Startup Delay
- System On
- Soft Shutdown
- System Disabled
- Remote Off (R to G)
- Shutdown Alarm
- Fans Only
- Economizing
- Cooling
- Heating
- Overrides Active
- Expansion Offline
- Unit Off Flow Active
- Occ Override Active
- Max Vent Seq Active
- Winter Ramp Active
- Morning Seq Active
- A2L Alarm Active

Unit Status Screen Symbols

Symbol	Indicates
	Supply air fan status. Rotation indicates airflow; static blades indicate no airflow.
	Cooling
	Heating
	Economizing

Input Output Status	
IO Type: All	
Ch#: Main U5	
Outside Air Temp	
Value:	95.0°F

INPUT OUTPUT STATUS

Displays real time conditions from sensors located in the unit and building space if equipped with space mounted sensors. Controller output conditions can also be viewed from this screen. To view the desired input/output point, the user must select the desired channel. Reference the unit schematics for individual point locations.

Space Thermostat		
1:	72.5°F	47.8%RH

SPACE THERMOSTAT STATUS

This screen displays the current temperature and relative humidity for up to four space thermostats that are communicated to the controller via Modbus.

Heat & Vent Status	
Active Mode:	Winter
Occupied:	Cycle
Unoccupied:	Cycle
Space Temp:	69.1

HEAT AND VENT STATUS SCREEN

This screen is only displayed if the controller is configured for heating and ventilating mode. It displays whether the unit is in summer or winter mode, how the unit is configured to operate in occupied / unoccupied times for that mode and the current space temperature.

Occupancy Status	
Status:	Occupied
Method:	Digital Input
Timezone	
11 CHICAGO	5:52 PM

OCCUPANCY STATUS

Displays current status of occupancy and the configured occupancy control method and time zone.

DAMPER Commanded Pos	
Outside Damper:	0%
Recirc Damper:	100%

DAMPER COMMANDED POS

This screen appears if equipped with modulating OA and recirculated air dampers. Displays current position of the OA damper.

SUPPLY Fan Status		
COMMAND	SIGNAL	STATUS
1: On	100%	On

SUPPLY FAN STATUS

This screen displays the fan enable command, fan proving status, and the supply fan ramp being sent from the controller to the VFD. The controller can modulate the fan between the min and max speeds.

Unit Status Overview

Exhaust Fan Status		
COMMAND	SIGNAL	STATUS
1:Off		Off

EXHAUST FAN STATUS

This screen displays the fan enable command, and fan proving status.

Airflow Status	
Outside Air:	0 cfm

AIRFLOW STATUS

This screen displays the current status of airflow volumes if the unit is provided with airflow monitoring. The outside airflow is an optional monitoring sensor that will appear when installed.

Ambient Lockout Status	
Heating:	Disabled
Cooling:	Allowed
Outside Temp:	95.0f

AMBIENT LOCKOUT STATUS

Displays heating and cooling lockout status based on the outside air ambient temperature. Ambient lockouts for heating and cooling can be altered by entering Main Menu/Ctrl Variables/Temp Control.

Outside Reset	
Outside Temp:	95.0f
Supply Spt:	55.0f
Active Spt:	55.0f

OUTSIDE RESET

This screen will be active if the controller is configured for outside air reset. The heating and cooling devices modulate to maintain the supply air temperature setpoint as determined by the outside reset calculation.

Active Reset	
Supply Temp:	70.0f
Supply Spt:	72.0f
Cooling Spt:	74.0f
Heating Spt:	70.0f
Active Spt:	72.0f

ACTIVE RESET

This screen will be active if temperature control mode is set for space or return air reset. The supply temperature setpoint is calculated based on the active setpoint and the current space or return temperature. The calculated setpoint is scaled between the supply temperature min and max setpoints determined by the current mode of operation.

Supply Setpoint	
Supply Temp:	71.5f
Setpoint:	72.0f

SUPPLY SETPOINT

This screen is active when supply temp control is selected or the active mode of control. Displays current supply temperature and supply temperature setpoint to be achieved.

Economizer RAMP	
Setpoint:	72.0f
Temp:	71.5f
Ramp:	Disabled
Mode:	0%
Outside Dry Bulb	

ECONOMIZER RAMP

The economizer ramp screen will be active if the unit is configured for economizer control. This screen displays the economizer setpoint, supply air discharge temperature, economizer ramp status, and economizer control mode.

CO ₂ RAMP OUTPUT	
Setpoint:	1000PPM
CO ₂ Level:	0PPM
Ramp:	Disabled

CO₂ RAMP OUTPUT

The CO₂ Ramp Output screen will be active if the unit is configured for CO₂ control. This screen displays the CO₂ setpoint, CO₂ level from the space, and the status of the control ramp.

Cooling RAMP	
Setpoint:	72.0f
Supply:	70.0f
Ramp:	Disabled
Capacity:	0%

Press ENTER for detail

COOLING RAMP

This screen displays the active setpoint, supply discharge temperature, cooling enable/disable, cooling ramp being sent from the controller, and the overall capacity being demanded.

Unit Status Overview

Compressor Request			
COMP/ALL	RAMP	CIRCUIT	
1:On	26%	1	A

COMPRESSOR REQUEST

The compressor request screen will be active if the unit is equipped with DX cooling. This screen displays overall status of individual compressor operation being sent from the unit controller. Example: Circuit A compressor enable (On) with modulating value of 26%.

Evaporative Cooling Status	
Valve Status:	Open
Pump Status:	Active
Drain Flush:	Inactive
Elapsed Time:	0m

EVAPORATIVE COOLING STATUS

This screen shows the status of the evaporative cooler. Valve status indicates the supply valve status (drain valve will be opposite).

Heating Ramp	
Setpoint:	72.0F
SUPPLY:	71.5F
RAMP:	Disabled 0%

HEATING RAMP

This screen displays the active setpoint, supply air temperature, status of the heating control ramp, and heating ramp being sent from the controller.

Furnace Status	
1:	Off
2:	Mod Signal: 0%
3:	Off
Furnace Stage:	0 of 6

FURNACE STATUS

This screen displays the status of the furnace(s) installed in the unit. One modulating with up to two additional fixed stage furnaces will show the status of each furnace. The status of each furnace tells what mode of operation the furnace is currently in. The number of furnace stages on and the total number of stages appear at the bottom of the screen.

Direct Gas Status	
Digital Out:	Enabled
Signal:	100%
Status:	Burner On
Main Gas Valve:	Open
Flame Safeguard:	Normal

DIRECT GAS STATUS

This status screen will be active if the unit is equipped with direct gas heating. This screen displays the status of the heat enable digital output, heating output signal sent to the modulating gas valve and the status of the digital inputs for the gas valve and flame safeguard alarm.

Supply Space Static	
Output:	0.0%
Static:	0.000"WC
Setpoint:	0.050"WC

SUPPLY SPACE STATIC



This screen displays status points if the unit is configured for space static pressure control. Status points include controller output ramp, static pressure in the space, and the space static pressure setpoint.

Supply Duct Static	
Output:	0.0%
Static:	0.000"WC
Setpoint:	1.000"WC

SUPPLY/RETURN DUCT STATIC

This screen displays status points if the unit is configured for duct static pressure control. Status points include controller output ramp, static pressure in the duct, and the duct static pressure setpoint.

Menu

The controller is equipped with several menus to help guide users with altering program parameters. The following menus can be accessed by pressing the  button. To enter the desired menu, press the  button.

Unit Enable

The **Unit Enable** menu allows the user to enable and disable the unit through the controller. Reference sequence of operation for additional unit starts/stop details.

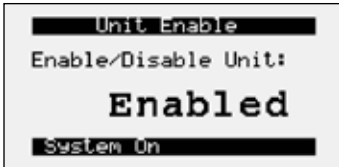

The unit ships from the factory in a disabled state. To allow the unit to operate, the controller must receive a run command from the remote start input. Please see unit schematics to verify location. **Jumper unit terminals R - G to allow the unit to operate.**

Change to (Enabled/Disabled): Enables user to manually turn unit on/off via display. Unit terminal **G** must have 24 VAC power to enable the unit.

Control Variables

The **Control Variables** menu allows the user to view and adjust unit control parameters.

Control Variables

 Temp Control

The **Temperature Control** menu allows the user to view and adjust temperature control conditions of the unit. Economizer setpoint adjustment is also found at this location if the unit is equipped with outside air and recirculation dampers.

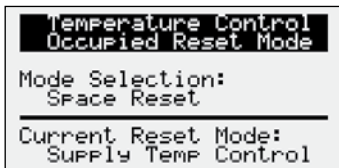

RESET MODES FOR TEMPERATURE CONTROL

Reset Mode selections are available for both occupied and unoccupied operation. Unoccupied Unit Operation is available when Unoccupied Reset Mode is selected to Normal Operation or Recirculation with Unoccupied Setpoints. The Unoccupied Reset Mode will hide when Night Setback or Off is selected for Unoccupied Unit Operation.

Setpoint Selections:

Supply Temp Control – The supply discharge setpoint is a constant value (e.g. 72°F). Reference Temperature Setpoint screen for setpoint adjustment.

Space Reset – The controller will reset the supply air temperature setpoint to maintain the space temperature setpoint (requires space temp sensor). Reference the Temperature Setpoint screen for space setpoint adjustment.

OA Reset – The controller monitors the OA temperature and adjusts the desired supply temperature setpoint accordingly. For example, when the OA is below 55°F, the controller will change the supply setpoint to 70°F. If the OA is above 65°F, the controller will change the supply setpoint to 55°F. If the OA temperature is between 55°F and 65°F, the supply setpoint changes according to the OA reset function. A visual representation of the OA reset function is shown below. Reference Outside Setpoints for min and max outside air limits.

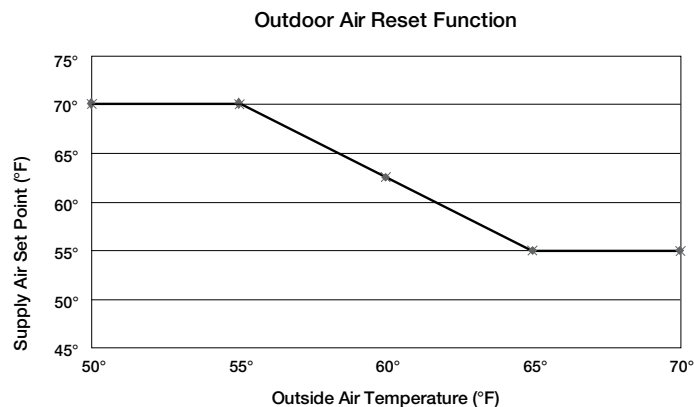

```

Temperature Control
Occupied Temp Reset
Setpoint:      72.0°F
Deadband:      4.0°F
-----
Cooling Spt:   74.0°F
Heating Spt:   70.0°F
    
```

```

Temperature Control
Occupied Supply Temp
Setpoint:      78.0°F
-----
Supply temp control
setpoint during
occupied operation.
    
```

```

Heat Cool Deadband
Deadband:      4.0°F
-----
Setpoint:      72.0°F
Cooling Spt:   74.0°F
Heating Spt:   70.0°F
    
```

```

Temperature Control
Unoccupied Temp Reset
Setpoint:      70.0°F
Deadband:      20.0°F
-----
Cooling Spt:   80.0°F
Heating Spt:   60.0°F
    
```

```

Temperature Control
Unoccupied Supply Temp
Setpoint:      65.0°F
-----
Supply temp control
setpoint during
unoccupied operation.
    
```

```

Temperature Control
Cooling Reset Limits
Maximum:       90.0°F
Minimum:       55.0°F
-----
Min & max reset values
Occupied & Unoccupied
    
```

```

Temperature Control
Heating Reset Limits
Maximum:       90.0°F
Minimum:       55.0°F
-----
Min & max reset values
Occupied & Unoccupied
    
```

```

Temperature Control
Unoccupied Hysteresis
Cooling:       5.0°F
Heating:       5.0°F
-----
Hysteresis to turn off
for Night Setback.
    
```

```

Temperature Control
Outside Reset
OR Temp      Spt.
55.0°F >>>  90.0°F
65.0°F >>>  55.0°F
-----
Supply Spt.: 55.0°F
    
```

```

Temperature Control
Mode Switch Delay
Delay:        120s
-----
Delay before switching
between heating and
cooling modes.
    
```

TEMPERATURE SETPOINT

This screen only appears if supply temp control, space reset, or return air reset, is selected as the reset control mode.

Setpoint Selections:

Local – The space setpoint will be constant; set from screen (e.g. 72°F).

BMS – The BMS can directly control the space temperature setpoint (requires BMS communication option).

T-Stat – The space setpoint will be adjustable from the space thermostat.

Reference Appendix: Space Thermostat Quick Start for additional information.

DEADBAND

When space reset or return air reset is selected, the setpoint and deadband screen appears. The deadband allows for separate cooling and heating setpoints.

UNOCCUPIED TEMPERATURE SETPOINT

The unoccupied temperature reset and supply temperature setpoint operation works the same as occupied when the unoccupied unit operation is selected as Normal operation with unoccupied setpoints or Recirculation with unoccupied setpoints.

When night setback cycle is selected, please see the sequence of operation for Setpoint Control (Night Setback) section.

TEMPERATURE RESET SETPOINTS

Cooling and heating reset limit screens only appear if space reset, or return air reset is selected for occupied or unoccupied operation. These screens allow the user to set the min and max setpoint limits for cooling or heating operation. The controller will adjust the supply temperature setpoint between the set limits depending on mode of operation.

UNOCCUPIED HYSTERESIS

When the unit is operating in Unoccupied Night Setback, the sequence uses a hysteresis added(heating) or subtracted(cooling) from the setpoint to turn the unit back off.

OUTSIDE RESET SETPOINTS

This screen only appears if outside reset is selected as the reset control mode.

MODE SWITCH DISPLAY

This screen displays the delay time required before switching between heating and cooling mode.

```

Temperature Control
Startup Delay
Delay: 30s
-----
Delay before enabling
unit ctrl at startup.
    
```

```

Temperature Control
Cooling
Amb Lockout: 55.0°F
-----
Outside Temp: 70.0°F
Currently Allowed
    
```

```

Temperature Control
Economizer
Amb Lockout: 40.0°F
-----
Outside Temp: 70.0°F
Currently Allowed
    
```

```

Temperature Control
Heating
Amb Lockout: 80.0°F
-----
Outside Temp: 70.0°F
Currently Allowed
    
```

```

Temperature Control
Winter Ramp
Enable: Yes
Mode: Supply Fan
OAT Enable: 40.0°F
-----
Outside Temp: 70.0°F
    
```

```

Temperature Control
Space Thermostat
Quantity: 1
-----
Quantity includes
t-stats & touchscreen.
    
```

```

Temperature Control
Economizer Mode
Selected Mode:
Outside Dry Bulb
-----
Active Mode:
Outside Dry Bulb
    
```

```

Economizer Settings
Outside Dry Bulb
Setpoint: 65.0°F
-----
Sensor Status: Valid
Mode Status: Not Ready
Econ Status: Disabled
    
```

```

Economizer Settings
Hysteresis
Temperature: 2.0°F
    
```

STARTUP DISPLAY

This screen displays the delay time after the fans have started and tempering begins.

COOLING LOCKOUT

This screen displays the cooling lockout temperature. Cooling will be disabled when outside air is below the cooling lockout temperature (80°F).

Note: Evaporative cooling will be enabled and run continuously when outside air temperature rises above this setting and will be disabled when outside air temperature is below this setting.

ECONOMIZER LOCKOUT

The screen displays the economizer lockout temperature when economizer is enabled in the unit. Economizer is not available when the outside air temperature is below the lockout temperature (40°F).

HEATING LOCKOUT

This screen displays the heating lockout temperature. Heating will be disabled when outside air is above the lockout temperature (65°F).

WINTER RAMP

The winter ramp function prevents the supply temperature from dropping below setpoint under the following conditions:

- Outside air temperature is below the winter ramp enable setpoint; and
- Heating capacity is at 100%

One of the following is used to perform the winter ramp function:

- Supply fan speed; or
- Outside air damper position

MODBUS SPACE T-STAT

The quantity of thermostats installed in the space that communicate the temperature, and set point to the controller. The controller averages the temperature readings when there is more than one installed. See Appendix C for more information.

ECONOMIZER MODE

The economizer screen appears when economizer function is enabled.

The outside air damper will modulate between the min and max position to maintain the supply temperature setpoint.

The user can select the economizer control method from the following options:

Outside Dry Bulb – Economizing is allowed when the outside dry bulb is less than the economizer temperature enable setpoint 65°F.

ECONOMIZER SETTINGS

There is a built-in hysteresis that disables economizer above the economizer setpoint.

(Example: If economizer outside dry bulb = 65°F, economizer operation is disabled above 67°F.)



Control Variables

↳ Heat & Vent

```
Heat & Vent
Mode Override
-----
Override:      Auto
Override Mode: Winter
-----
Current Mode: Winter
```

```
Heat & Vent
Changeover Settings
-----
Setpoint:      65.0F
Hysteresis:    15.0F
-----
Winter: Space < 65.0F
Summer: Space > 80.0F
Space TEMP:    69.1F
```

```
Heat & Vent
Summer Mode
-----
Occupied:      Continuous
Unoccupied:    Off
-----
Winter Mode
-----
Occupied:      Cycle
Unoccupied:    Cycle
```

```
Heat & Vent
-----
Summer Lockout: 55.0F
-----
Summer mode locked out
when OAT < Lockout.
OAT TEMP:      45.1F
```

```
Heat & Vent
Exhaust Relief
-----
Summer Mode:   Always
Winter Mode:   Occ Only
-----
Allows relief contact
during selected mode
if SUPPLY fan enables
```

Control Variables

↳ Evap Cooling

```
Evap Cooling Setup
SUMP Fill
-----
Duration:      90s
```

```
Evap Cooling Setup
Auto Drain Flush
-----
enable:        Yes
Delay:         24h
Duration:      10m
-----
Status:        Inactive
Elapsed Time:  0m
```

Control Variables

↳ Refrigeration
↳ Compressor Control

The **Heat & Vent** Mode menu is only available when the unit is configured for the heating and ventilating sequence and allows adjustments of the heat and vent mode changeover settings, and allows configuration of the summer and winter modes.

MODE OVERRIDE

The heat and vent mode menus will be active when the unit is configured for the heating and ventilating sequence. By default the unit will changeover between summer and winter mode based upon the room temperature. Enabling manual mode will allow the user to change between summer and winter mode on this menu.

CHANGEOVER SETTINGS

When manual mode is disabled, the controller will switch between summer and winter modes based on the space temperature. When the temperature falls below the setpoint, the unit will be in winter mode. When the temperature rises above the setpoint plus the hysteresis, the unit will be in summer mode.

HEAT & VENT MODES

Continuous – The supply fan will run continuously. Heating will be enabled in winter mode and supply temperature setpoint will be reset by space temperature.

Cycle – (Winter mode only) the supply fan will cycle upon a call for heating (space temperature falls below the setpoint) and the supply temperature setpoint will be elevated to maximum reset limit.

Off – The unit will be disabled.

SUMMER LOCKOUT

When outside air temperature falls below the summer lockout setpoint, the unit will be locked into winter mode.

EXHAUST RELIEF

A digital output is reserved to provide a dry contact that can be used to enable an exhaust fan or open a relief damper. When enabled this contact will close when the supply fan is enabled. It can be configured to close during occupied mode, unoccupied mode, always (both modes) or never.

The **Evap Cooling** menu allows the user to adjust the evaporative cooling auto fill and drain settings. If equipped with evaporative cooling.

SUMP FILL

This screen allows adjustment of the delay time between when the evaporative cooling valves are energized and the evaporative cooling pump is enabled. This provided time for the sump to fill partially before energizing the sump.

AUTO DRAIN FLUSH

This screen allows auto drain and flush to be enabled/disabled. When enabled the elapsed timer begins when the sump is filled. When the elapsed time reaches the delay setting, the sump will be drained and the pump will be disabled. The duration setting sets how long the sump is drained. This sequence is intended to reduce mineral buildup by bringing fresh water into the sump.

COMPRESSOR CONTROL

Consult factory prior to adjusting parameters in the compressor control menu.

Control Variables

↳ Damper Control

The **Damper Control** menu's allows the user to adjust damper control setpoints.

FAN DAMPER DELAY

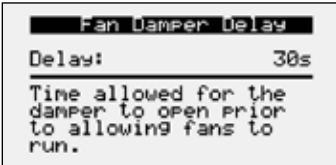

This screen allows adjustment for delay time between damper opening and fan operation. This timer allows the damper to open before the fan start sequence begins. This prevents the fans from having to overcome higher static pressure when the damper(s) are opening.

OUTSIDE DAMPER POSITION - OCCUPIED



This screen only appears if equipped with a modulating OA and recirculating damper. The screen displays the min and max positions for the outside air damper. These setpoints reflect the percentage of the outside air damper being opened.

0% = Full recirculation air | 100% = Full outside air

*Note: If the unit is equipped with a modulating OA damper but intended to be 100% outside air, the minimum and maximum should both remain at 100%.



Minimum Position – When in the occupied mode, the active setpoint will be equal to a local minimum OA setpoint, which may be constant or reset by fan speed if equipped with a modulating supply fan.

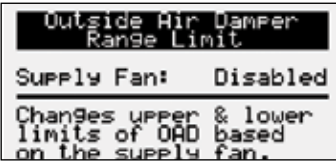

Maximum Position – Each sequence that can adjust the OA damper setpoint contains a maximum position to prevent excess OA. The active setpoint will be determined based on the greatest demand of the configured sequences.

The OA damper setpoint can then be further adjusted between the minimum and maximum OA settings with sequences such as CO₂, Building Pressure and Economizer.

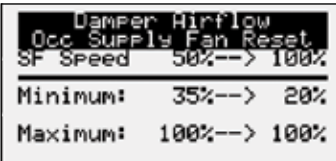

Setpoint Selections:

Constant Position – The min OA percentage is constant; set by the controller.

SF Reset – The min and max positions are reset by the supply fan speed.

BMS – The BMS can directly control the OA damper position between the min and max percentages.



Space Static – Damper position is reset by a building pressure control loop.

CO₂ – Damper position is reset by a demand-controlled ventilation control loop based on space CO₂ levels. The CO₂ max is the highest percentage that the OA damper can modulate when solely based on CO₂.

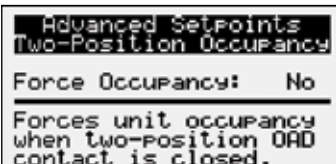

2-Position – Damper sequence that utilizes a contact closure to determine which position the OA damper is commanded; minimum or maximum. The “Max Vent” contact closure maybe be field configured to temporarily force the unit into occupied mode. Reference Ctrl Variables/Advanced/Advanced Setpoints/Max Vent to enable this option.

0-10 By Others – The 0-10V signal directly correlates to the damper position of 0-100%. When the signal is below the minimum damper position setpoint, the damper will modulate to minimum position. When the signal is above the maximum damper position setpoint, the damper will modulate to max position.



OUTSIDE DAMPER POSITION - UNOCCUPIED

Occupied and unoccupied damper control have minimum and maximum set points for the specific mode of operation. Unoccupied OA Damper control typically will only show the minimum set point. The maximum will also appear if the OA Damper is controlling to building pressure.

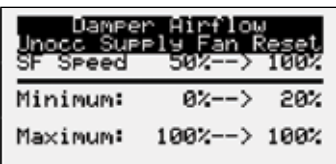

Control Variables

- ↳ Fan Control
 - ↳ Supply Fan Control

The **Supply Fan Control** menu allows the user to adjust supply control setpoints.

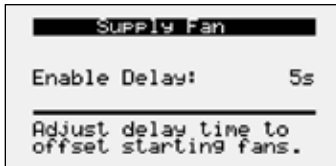

SUPPLY FAN DELAY

The supply fan delay will begin once the damper sequence is complete. This delay can be used to offset starting times between the supply fan and exhaust fan.

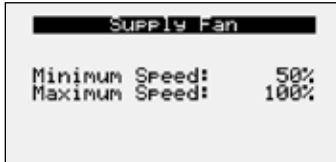

SUPPLY FAN SPEED

This screen displays min and max supply fan speed percentages. The speed setpoint is the proportional percentage of the analog output from the controller to the VFD.

50% Speed = Min speed

100% Speed = Max speed

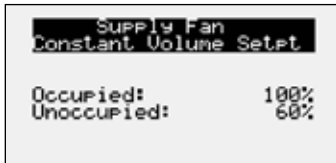

Setpoint Selections:

Constant Volume – The fan speed will be constant; set from screen (e.g. 100%).

BMS – The BMS can directly control the fan speed (requires BMS communication option).

Duct Pressure – Fan speed is determined by duct pressure control loop.

Space Static – Fan speed is determined by building pressure control loop.

CO₂ – Fan speed is determined by CO₂ control loop.

Single Zone VAV - The supply fan is modulated in addition to the supply air temperature to satisfy the space temperature setpoint.

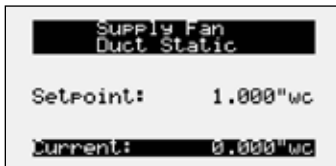

2-Speed - Supply fan control utilizes a contact closure to determine which speed the supply fan speed is commanded; minimum or maximum. The “Max Vent” contact closure maybe be field configured to temporarily force the unit into occupied mode. Reference Ctrl Variables/Advanced/Advanced Setpoints/Max Vent to enable this option.

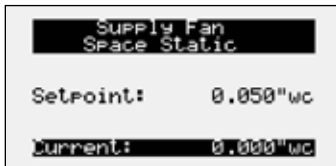

0-10 By Others – The 0-10V signal directly correlates to the fan speed of 0-100%. When the signal is below the minimum fan speed setpoint, the fan will operate at minimum. When the signal is above the maximum fan speed setpoint, the fan will operate at maximum.

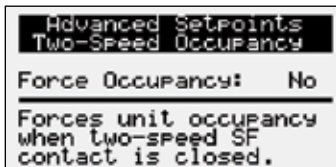
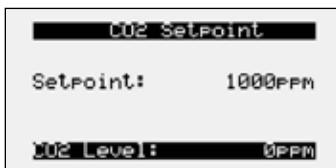

SOFT SHUTDOWN ENABLE

During a soft shutdown the following will occur:

- Tempering outputs immediately revert back to their off value; while
- Dampers remain open and fans continue to run; until
 - The supply air temperature falls below the soft shutdown enable setpoint minus 5°F; or
 - The soft shutdown delay (0 sec adj.) timer has expired.



Control Variables

- ↳ Fan Control
- ↳ Exhaust Fan Control

The **Exhaust Fan Control** menu allows the user to adjust exhaust control setpoints.

DELAY AND ENABLE

This screen displays the exhaust fan delay and enable based on OA damper position. The exhaust fan delay will begin once the damper sequence is complete. This delay can be used to offset starting times between the supply fan and exhaust fan. This screen also provides the ability to enable the exhaust fan on a set OA damper position if the unit is equipped with a modulating OA damper.

Control Variables

- ↳ Occupancy

The **Occupancy** menu allows the user to adjust occupancy control parameters which includes occupancy control mode and schedule.

OCCUPANCY CONTROL

This screen displays the current mode of operation for occupancy control. Status of the other mode option can also be found on this screen. This screen allows the user to select the source of determining occupancy. The factory default is BMS control.

BMS: BMS front end sends an occupancy enable/disable to the controller via a selected protocol. (Reference Points List).

Digital Input: Typically used with a remote time clock, motion sensor or switch.

Always Occ: Controller will always remain occupied.

Always Unocc: Controller will always remain unoccupied.

Schedule: Allows the user to set an occupancy schedule for each individual day of the week.

Override: Informs the user that the unit is overridden to occupied from an external source. When *DI Ovr Act*, is displayed, the digital input for occupancy is being used as an override and is active. When *TOV Active* is displayed, the timed override feature has been activated at the space thermostat.

OCCUPANCY SCHEDULE

This screen allows the user to adjust the schedule based on the day of the week. The user will select one of the following for each day of the week.

Occupied: Unit will be always occupied (default when schedule is selected).

Unoccupied: Unit will be always unoccupied.

Schedule: Requires the user to enter a start time, stop time and the applicable days of the schedule.

UNOCCUPIED START ENABLE MODES

This screen only appears if unit is provided with unoccupied recirculation.

This screen allows the user to enable/disable modes of operation when in unoccupied recirculation control.

SPACE T-STAT OCCUPANCY TIMED OVERRIDE

This screen allows the user to set the duration for occupancy override. This feature is then triggered at the factory-provided space thermostat occupancy button. Please see Appendix C for further information.

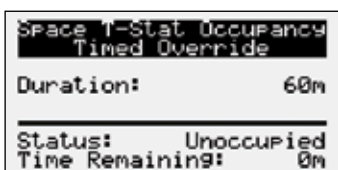
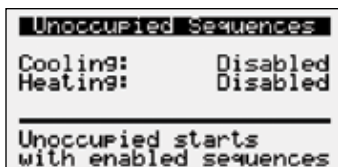
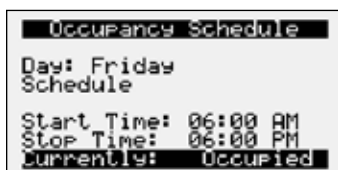
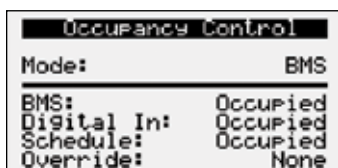
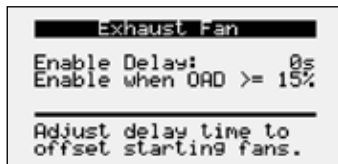

```

Occupancy Override
Digital Input
Unoccupied Delay: 0m
Reset Occupancy: No
-----
Status: Occupied
Time Remaining: 0m
    
```

Control Variables

↳ Advanced

```

User Login
Enter Password: 1000
-----
Current Access:
Service Level
    
```

Control Variables

↳ Advanced
↳ Manual Overrides

```

Manual Unit Override
Overrides: Disabled
Duration: 180m
-----
Time Remaining: 0:00
Status: Disabled
    
```

```

IG Furnace Setup
Press ENTER to access
IG Furnace Commission
-----
Unit must be running
    
```

```

DG Furnace Setup
Press ENTER to access
DG Furnace Commission
-----
Unit must be running
    
```

```

Unit On Off
Override: Auto
Value: On
-----
enable Main Override
    
```

```

Occupancy
Override: Auto
Value: Occupied
-----
enable Main Override
    
```

```

Outside Damper
Override: Auto
Position: 35%
-----
enable Main Override
    
```

OCCUPANY OVERRIDE DIGITAL INPUT

This screen allows the user to set the unoccupied delay duration and reset occupancy override. This feature is then triggered by the occupancy override digital input.

The **Advanced** menu allows the user to access several submenus regarding controller information, controller overrides, network settings, I/O configuration, and unit configuration. Submenu options are read only and will require the user to input proper login criteria. The **service password (1000)** is required to change service access menus. Consult factory for factory level access.

The **Manual Overrides** menus are for start-up, commissioning, and troubleshooting.

MANUAL OVERRIDE MODE

The Manual Overrides menu is for start-up, commissioning, and troubleshooting. This menu allows the user to override the control loops and specific inputs and outputs.

To access the Manual Overrides submenus, enter the **service password (1000)**. Manual overrides must be enabled at this screen to allow the user to override control loops. Override options must be changed from Auto to Manual for manual control.

IG FURNACE COMMISSIONING MENU

This screen only appears if an indirect gas furnace was provided with the unit. Entering the furnace commissioning menu will step the user through the furnace start-up.

DG BURNER COMMISSIONING MENU

This screen only appears if direct gas heating was provided with the unit. Entering the burner commissioning menu will step the user through the burner start-up.

OVERRIDE UNIT ON OFF

When manual override is set to enable, use the arrow buttons to turn the unit on or off.

OVERRIDE OCCUPANCY CONTROL

When manual override is set to enable, use the arrow buttons to change occupancy control.

OVERRIDE OUTSIDE DAMPER POSITION

This screen only appears if the unit is equipped with a modulating OA. The recirculation damper position, if equipped, will be the inverse of the OA damper position shown.

0% = Outside air damper closed

100% = Outside air damper fully open

```

Supply Fan
Override: Auto
Command: On
Speed: 100%
Enable Main Override
    
```

VERRIDE SUPPLY FAN SPEED

The speed is the proportional percentage of the analog output from the controller to the VFD.

0% Speed = Min speed (determined by VFD)

100% Speed = Max speed (determined by VFD)

(Reference unit Installation and Operation Manual for VFD programming).

```

Exhaust Fan
Override: Auto
Command: On
Enable Main Override
    
```

VERRIDE EXHAUST FAN

When manual overrides are enabled, use the arrow buttons to change the override and command to enable the exhaust output.

```

Compressor Request
Override: Auto
1: Off 2: Off
Enable Main Override
    
```

VERRIDE COMPRESSORS

This screen only appears if the unit is equipped with DX cooling. When manual override is set to enable, use the arrow buttons to turn individual compressor requests on or off.

```

Compressor Signal
Override: Auto
1: 0%
Enable Main Override
    
```

VERRIDE MODULATING COMPRESSOR SIGNAL

When manual override is set to enable, use the arrow buttons to change the modulating compressor speed.

```

Cooling Ramp
Override: Auto
Demand: 0%
Enable Main Override
    
```

VERRIDE COOLING

When the cooling control is in the manual mode, use the arrow buttons to vary the cooling output.

Chilled Water: The cooling percent is directly proportional to the 0 - 10 VDC output signal.

0% Cooling = 0 VDC | 100% Cooling = 10 VDC

Packaged Cooling: The cooling percent displays compressor engagement as a percent. The compressors are subject to the min on/off times and heating/cooling lockouts.

```

Evaporative Cooling
Override: Auto
Valve: Off
PUMP: Off
Enable Main Override
    
```

VERRIDE EVAPORATIVE COOLING

When evap cooling is in manual mode, use the arrow buttons to enable and disable to the valve and pump for the cooling.

```

Mod Furnace Request
Override: Auto
FIS1: Off
Mod Signal: 0%
LPS: Hi Spd Fan:
HPS: Gas Ulv 1:
Alm:
1: Off
    
```

VERRIDE FURNACE REQUEST

This screen appears to override the modulating furnace signal from the controller. Use the arrow buttons to increase or decrease the capacity of the modulating furnace.

```

Furnace 2 & 3 Request
Override: Auto
F2S1: Off  F2S2: Off
F3S1: Off
Gas U1v 2:  Alm 2:
Gas U1v 3:  Alm 3:
2: Off
3: Off
    
```

```

IG Alarm Bypass
Bypass:      Disabled
Allows mod furnace to
continue running
during an alarm state.
    
```

```

IG Burner
Override: Auto
Command:  On
Demand:   0%
OR: 70.0% SA: 70.0%
DG Burner Off
    
```

```

Electric Heat
Override: Auto
Elec Heater 1: 100%
Enable Main Override
    
```

```

Heating Ramp
Override: Auto
Demand: 100%
Enable Main Override
    
```

```

Economizer Ramp
Override: Auto
Value: 0%
Enable Main Override
    
```

Control Variables

- ↳ Advanced
- ↳ Advanced Setpoints

```

Advanced Setpoints
Unocc Unit Operation
Mode:
Night Setback Cycle
    
```

```

Advanced Setpoints
Space T-Stat Settings
Timed Override: Allowed
Setpt Adjust: Allowed
Allows remote setpoint
adjustment & occupancy
timed override.
    
```

```

Advanced Setpoints
Occupancy Override
Digital Input: Allowed
Allows digital input
to override occupancy.
    
```

OVERRIDE FURNACE SIGNAL

This screen appears to override the staged furnaces from the controller. Use the arrow buttons to turn on or off the staged furnaces.

IG ALARM BYPASS

This screen allows the furnaces to continue to run in a alarmed state to allow troubleshooting of furnace alarms. Safety related alarms will not be bypassed.

OVERRIDE DIRECT GAS BURNER

When heating control is in manual mode, use the arrow buttons to enable the direct gas burner and select a demand value.

OVERRIDE ELECTRIC HEAT

When This screen only appears if the unit is equipped with electric post heat. Electric heater percentage is directly proportional to the 0 – 10 VDC output signal.

OVERRIDE HEATING

When the heating control is in the manual mode, use the arrow buttons to vary the heating output.

OVERRIDE ECONOMIZER CONTROL

When the heating control is in the manual mode, use the arrow buttons to vary the output of the economizer ramp. This value may have an effect on the modulating outside air damper position.

The **Advanced Setpoints** Menu allows the user to view and modify network settings. The **service password (1000)** is required to make changes.

UNOCCUPIED UNIT OPERATION

Possible unoccupied unit operation methods include:

- Unit Off
- Night Setback Cycle
- Recirculation with Unoccupied Setpoints
- Normal Operation with Unoccupied Setpoints

SPACE T-STAT SETTINGS

This screen allows the user to allow timed override occupancy and/or setpoint adjustment from the space thermostat.

OCCUPANCY OVERRIDE

This screen allows the user to allow the digital input to override occupancy.

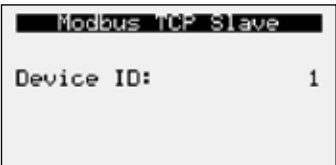
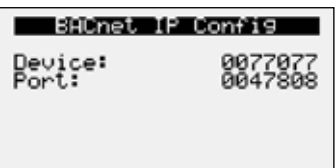
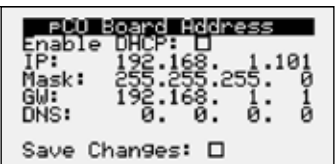
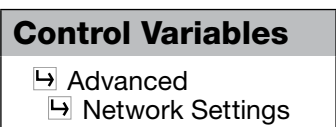
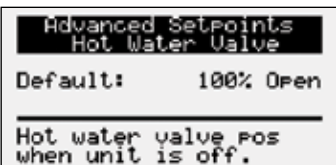
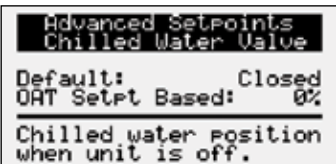
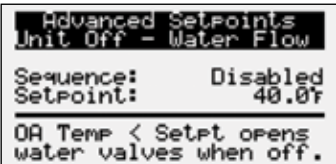
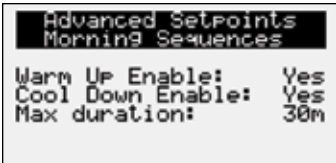

MORNING WARM UP AND COOL DOWN

This screen will appear when the unit has a recirculating air damper installed. The user can enable morning warm up, morning cool down, and set the duration for the sequence.

ADVANCED SETPOINTS - UNIT OFF-WATER FLOW

When the unit is off or in standby and the outside air temperature is below the setpoint, the water valves will be set to a fixed position to allow water flow.

CHILLED WATER VALVE

This screen allows the user to set the chilled water valve position when Unit Off Protection is operational.

HOT WATER VALVE

This screen allows the user to set the hot water valve position when Unit Off Protection is operational.

The Network Settings Menus allows the user to view and modify network settings. The **service password (1000)** is required to make changes.

C.PCO BOARD ADDRESS

This screen will appear with or without a network protocol provided with the unit.

This screen allows the user to configure the IP setting for BMS and/or when the Web User Interface will be utilized. The controller may have a DHCP server-assigned address or a manually-assigned static IP address. Factory settings are shown in the screen to the left.

BACNET IP CONFIG

This screen will appear if the unit is set for BACnet IP and allows the user to set the device and port settings.

MODBUS TCP SLAVE

This screen will appear if the unit is set for Modbus TCP and allows the user to set device ID number.

BACNET MSTP PARAMETERS

This screen only appears if the selected BMS protocol is set to BACnet MSTP. Factory settings are shown in the screen to the left.

To change BACnet MSTP parameters:

1. Go to Network Settings menu and view BACnet MSTP Config screen.
2. Move cursor to desired parameter by pressing the enter button. Press up and down arrows to adjust the parameter. Press enter to accept adjusted value.
3. Once desired parameters have been entered, enable the 'Save Settings' option and press the enter button.
4. Reboot the controller by cycling power to the unit or holding the main menu/target button for 3 seconds to stop the unit operation and restart the controller.



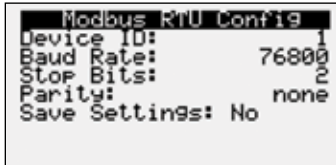

MODBUS RTU PARAMETERS

This screen only appears if the selected BMS protocol is set to Modbus. Factory settings are shown in the screen to the left.

To change Modbus RTU parameters:

1. Go to Network Settings menu and view Modbus RTU Config screen.
2. Move cursor to desired parameter by pressing the enter button. Press up and down arrows to adjust the parameter. Press enter to accept adjusted value.
3. Once desired parameters have been entered, enable the 'Save Settings' option and press the enter button.
4. Reboot the controller by cycling power to the unit. or holding the main menu/target button for 3 seconds to stop the unit operation and restart the controller.

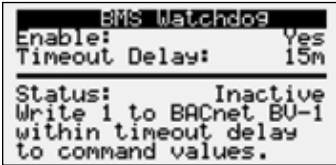

BMS WATCHDOG

The BMS watchdog function verifies BMS connectivity. The watchdog is required for the BMS to take the place of a hardwired sensor. The BMS toggles the watchdog variable from true to false within the timeout delay. If the timer expires, the controller falls back to hardwired sensors until the BMS connection can be established. At this time, a BMS watchdog alarm activates.

The following variables may be used by the BMS in place of hardwired sensors:

- Outside_Temp_from_BMS
- Space_1_CO2_from_BMS
- Return_CO2_from_BMS
- Space_Static_from_BMS
- Space_Temp_from_BMS



SENSOR SOURCE

The sensor source can be changed to source by BMS through the controller or by a dedicated BMS point. Reference Points in the Appendix for more detailed point information. The screen to the left is an example of the sensor source type. Source can be set for local or BMS at this screen.

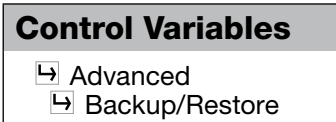

The **Backup/Restore** Menus allows the user to create a backup file of setpoints and configuration variables on a USB drive or in the controller's internal memory.



CONNECTING USB DRIVES

The controller has a built-in Micro USB port for connecting to USB drives. The USB drives can be used for backing up all settings and reported conditions such as alarm history and current values.

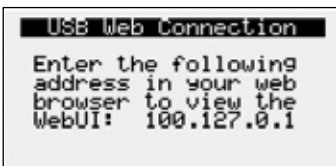
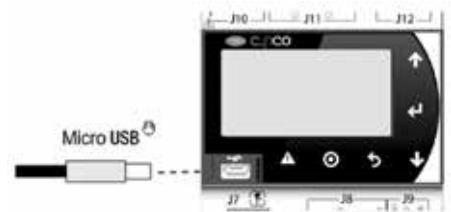

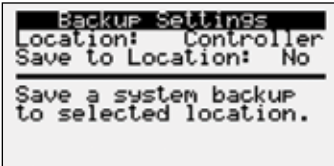

CREATING A BACKUP FILE

Important:

- At first startup or commissioning, or prior to communicating with Technical Support about performance issues, we recommend creating a backup file for each controller.
- Name each file with the unit sales order–line number found on the silver nameplate attached to the electrical access door.
- Also consider creating a backup file whenever significant program changes are made.

To create a system backup file using the handheld or virtual keypad/display buttons:

1. Go to the Main Menu/Ctrl Variables/Advanced/Login screen. Press the Enter and Up or Down arrow buttons to enter the service password, which is 1000.
2. Go to the Main Menu/Ctrl Variables/Advanced/Backup/Restore screen.
3. Press the Up or Down arrow buttons to navigate to the Backup Settings screen.
4. Press the Enter and Up or Down arrow buttons to select the backup location (internal memory or USB). If creating a backup to a USB drive, insert a USB drive into the main controller.
5. Press Enter to highlight and then the Up or Down arrow buttons to fill the Save checkbox. This action creates the backup file.



RESTORING FROM A BACKUP FILE

From USB

1. Place the restore file in the root directory of a USB drive. (Do not place the file within a folder on the USB drive.) The file must be named: User_Backup.txt
2. Insert the USB drive into the controller’s USB port.
3. Go to the Main Menu/Unit Enable screen. Press the Enter and Up or Down arrow buttons to disable the unit.
4. Go to the Main Menu/Ctrl Variables/Advanced/Login screen. Press the Enter and Up or Down arrow buttons to enter the service password (1000).
5. Go to the Main Menu/Ctrl Variables/Advanced/Backup/Restore screen.
6. Press the Up or Down arrow buttons to navigate to the USB Restore screen.
7. Press Enter to highlight and then the Up or Down arrow buttons to fill the Restore checkbox. This action restores the backup file. If there is an error during the process, the specific error is displayed on this screen.
8. Controller will automatically restart.

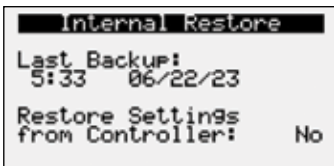

From internal memory

1. Go to the Main Menu/Unit Enable screen. Press the Enter and Up or Down arrow buttons to disable the unit.
2. Go to the Main Menu/Ctrl Variables/Advanced/Login screen. Press the Enter and Up or Down arrow buttons to enter the service password, which is 1000.
3. Go to the Main Menu/Ctrl Variables/Advanced/Backup/Restore screen.
4. Press the Up or Down arrow buttons to navigate to the Internal Restore screen. This screen is only available when a backup file exists in internal memory.
5. Press Enter to highlight and then the Up or Down arrow buttons to fill the Restore checkbox. This action restores the backup file. If there is an error during the process, the specific error is displayed on this screen.
6. Controller will automatically restart.

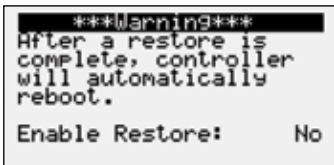

Menu

Control Variables

- ↳ Advanced
- ↳ I/O Configuration

```
I/O Configuration
IO Type: Analog Input
Supply Air Temp
Ch: M U4 Type: NTC

Value: 71.6°F
```

```
I/O Config Options
Devices Shown: Config

Scroll by configured
or all devices.
```

Control Variables

- ↳ Advanced
- ↳ Unit Config
- ↳ Service Config

```
Service Unit Config
Supply Fan Control

Type: Constant Volume
```

Commissioning

```
DG Furnace Setup

Press ENTER to access
DG Furnace Commission

Unit must be running
```

```
IG Furnace Setup

Press ENTER to access
IG Furnace Commission

Unit must be running
```

Alarms

```
Active Alarms 0/0

No Active Alarms

ENTER → Alarm History
ALARM → Alarm Reset
```

The **IO Configuration Menu** allows the user to view and modify controller input and output points.

I/O CONFIGURATION

This screen is read only and will require the factory password to make changes. The screen to the left is an example of an analog input configuration screen. Similar screens appear for remaining I/O when selected.

To monitor individual I/O points:

1. Press the enter button to highlight the I/O type.
2. Press the up and down arrows to change the IO type.
3. Press the enter button to highlight the controller channel.
4. Press the up and down arrows to change the channel.

I/O CONFIGURATION OPTIONS

Changes to the IO configuration requires the factory login password. Consult factory for IO configuration changes.

ADJUSTMENT OF I/O CONFIGURATION MUST ONLY BE DONE UNDER FACTORY GUIDANCE! IMPROPER ADJUSTMENT MAY RESULT IN SYSTEM DAMAGE!

The **Unit Configuration** menus allows the user to view the unit configuration provided from factory. Configuration menus listed below can be altered with the service password. Consult factory for unit configuration changes!

SUPPLY FAN CONTROL

Please reference the supply fan sequence section for possible control methods.

The **Commissioning** menu steps the user through the IG furnace and DG burner start-up.

DG BURNER COMMISSIONING MENU

This screen only appears if direct gas heating was provided with the unit. Entering the burner commissioning menu will step the user through the burner start-up.

IG FURNACE COMMISSIONING MENU

This screen only appears if an indirect gas furnace was provided with the unit. Entering the furnace commissioning menu will step the user through the furnace start-up.

The **Alarms** menu allows the user to view active alarms, reset active alarms and view, clear or export the alarm history.

ACTIVE ALARMS

If an alarm occurs, the button will glow red on the controller and the remote display (if installed).

To view alarm, press the Alarm button once. This will display the most recent alarm. If the alarm cannot be cleared, the cause of the alarm has not been fixed. Press the up and down buttons to view any additional occurring alarms.

Menu

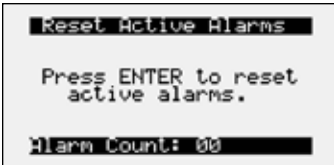

RESET ACTIVE ALARMS

This screen allows the user to clear active alarms.



ALARM EVENT HISTORY

This screen allows the user view recent alarms. To view all saved alarms, press the “down” button to enter the data logger.

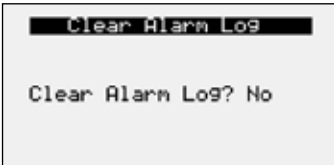

CLEAR ALARM LOG

This screen allows the user to clear all alarms in alarm log history.

Direct Gas Heating Alarm Descriptions		
Alarm	Description	Function
Pilot Flame Did Not Prove	Indicates the flame safeguard did not sense pilot flame. Check pilot gas pressure, flame sensor and ignitor.	Alarm and heat lockout
Check Heating Safety Circuit	Burner did not attempt ignition. Check high limit, high/low gas pressure switches (if equipped)	Alarm only
Check Flame Safeguard Functionality	Flame safeguard alarms but doesn't close the main valve. Verify flame safeguard is operating correctly	Alarm and heat lockout
Check burner pressure differential, refer to IOM for proper set up	Burner cycled repeatedly in a short window, typically due to burner differential pressure	Alarm Only
General FSG Alarm	Flame safeguard alarm after main valve was energized.	Alarm and heat lockout
Alarm reset at FSG Required	Alarm was reset on the microprocessor but has not been manually reset at the flame safeguard.	Alarm and heat lockout

In Direct Gas Heating Alarm Descriptions		
Alarm	Description	Function
IG no flame 3 try AL	Indicates a furnace failure to light or properly sense flame after 3 trials.	Alarm only
IG combustion fan high pressure switch failure	Indicates a call for high speed combustion fan but high pressure switch did not close.	
IG furnace ignition control	Indicates an alarm from the ignition controller.	
Pressure switch closed with combustion fan off	Indicates low pressure switch was closed with no call for combustion fan.	
Combustion fan not proved	Indicates a call for low speed combustion fan but low pressure switch did not close.	
IG furnace max retry	Indicates that the max number of retries was reached.	Alarm and Furnace lockout
IG High Temp AL	Indicates that power was lost from the High Temp Limit Sensor. Check for high limit trip.	Alarm only
IG offline	Indicates communication with furnace control has failed.	
IG LG man No Flame AL	No flame after 3 trials for ignition on the large manifold.	
IG High PSW with No call for heat	High pressure switch closed when furnace isn't running.	

Appendix A: Remote Display (pGD1)

The pGD1 is an optional remote display for use with manufacturer's microprocessor controllers. The remote display allows for remote monitoring and adjustment of parameters of the unit mounted controller. The remote display allows identical access to menus and screens as the unit mounted controller display. A remote display is not available when the unit has BACnetMSTP or Modbus RTU.



Specifications	
Carel Model	PGD1000W00
Power Supply	Power supplied from unit controller through RJ25 cable
Max distance from unit controller	150 feet
Required Cable	6P6C RJ25/RJ12 Cable (straight)
Operating Conditions	-4°F to 140°F, 90%RH (non-condensing)
Display Type	Backlit LED with lighted buttons

Installation

The remote display connects to the unit mounted controller through a six-wire RJ25 or RJ12 telephone cable. When ordered from the factory, a cable is provided with the remote display. The display and cable can be used to assist with start-up and maintenance.

Connecting Cable

If mounted remotely, the factory cable can either be extended or replaced with a longer cable up to the listed maximum distance.

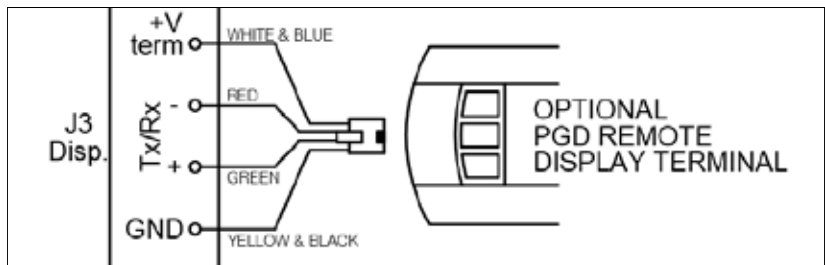

Appendix B: I/O Expansion Board (c.pCOe) Quick Start

The expansion board is an I/O module that can be used to monitor additional statuses or provide commands from large board controller. It allows the user to view and control:

- 6 Universal Inputs (Digital Input*, NTC, 0/1VDC, 0/10VDC, 0/20mA, 4/20mA, 0/5VDC)
*Only dry to ground contacts can be utilized for digital inputs. Applying voltage will result in damage to the I/O expansion board.
- 4 Analog Outputs (VDC)
- 6 Digital Outputs

The inputs and outputs can be monitored and controlled by the Building Management System. Reference Points List for detailed point information.

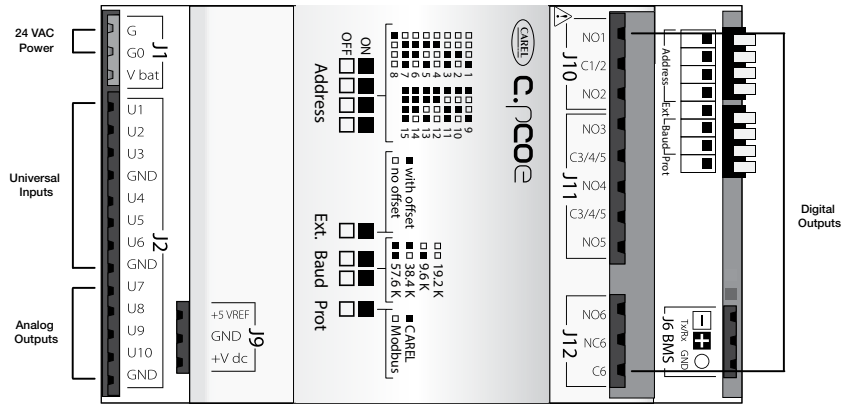

Setup

In order for the controller to communicate with the c.pCOe, several parameters must be adjusted. If you have a c.pCOe installed from the factory, the controller is already set up for communication with the main controller. The factory password is required for expansion board and I/O configuration updates. Consult factory for I/O configuration changes.

```

Expansion Type
EXP 1: Not installed
EXP 2: Not installed
EXP 3: Not installed
EXP 4: cPcoE
EXP 5: Not installed
EXP 6: Not installed
**Reboot Controller**
    
```

Enable the c.pCOe for Auxiliary I/O - To enable the c.pCOe expansion I/O module, go to Service Config. User will have to enter the Service Password to make any edits at this point. Consult factory for help configuring the expansion board. The expansion board must be enabled to configure spare I/O points. Once enabled, the user must reboot the controller. See screens to the left for expansion board enable points.

```

Service Unit Config
AUX IO - Monitor Only
AUX IO: Not Installed
    
```

Aux IO Installed - Checking the Aux IO Installed check box allows the Aux IO Config menu to show in the Control Variables menu. This is a shortcut to access the auxiliary I/O after it is configured in the I/O Configuration menu.

```

I/O Config Options
Devices Shown: Config
Scroll by configured
or all devices.
    
```

Configuring the I/O Type - In order to edit and configure the I/O configuration of the unit, go to Ctrl Variables/Advanced/I/O Configuration. The user must enable the Editable option for configuring I/O points. If configuring a new I/O point, 'Scroll by All Configured' must be deselected to view all I/O options.

```

I/O Configuration
IO Type: Analog Input
Aux In Customer 5
Ch: E4 U5 Type: 0-10U
Min: 0.0°F
Max: 100.0°F
Value: 32.0°F
    
```

Change or Update the I/O Point - Once the editable option is selected, the user must scroll to the I/O Configuration Menu. At this menu the desired I/O type can be selected. Once selected the user can configure the desired channel at the expansion board. The channel will have an 'E' designation for expansion board. Aux In Customer 1-6, Aux Analog Out 1, and Aux Digital Out 1-2 will be allocated for the I/O expansion board.

```

AUX I/O Config
Aux In Customer 5
Ch: E4 U5 UM: °F
Type: 0-10U
Min: 0.0°F
Max: 100.0°F
Value: 32.0°F
    
```

Viewing c.pCOe Auxiliary Values - Once the expansion board I/O is configured, the user can view and/or change the I/O type by navigating to Ctrl Variables/Aux I/O Config.

Appendix C: Space Thermostat Quick Start



The space thermostat gives users the ability to view the space temperature and control the active space setpoints from the adjustable display. The space thermostat also has the ability to send the unit into temporary occupied mode. Up to four space thermostats can be wired back to the microprocessor to provide an average for the space temperature. The space thermostat is shipped loose with installation by others and is a Modbus connected device.

Space thermostat functions:

- Temporary occupancy override control
- Temperature monitoring
- Temperature setpoint adjustability
- Status icon on LCD display with push buttons

Display

If more than one space thermostat is provided for averaging, only one space thermostat will be provided with a display and push buttons for adjustment. If touchscreen is provided, reference Appendix D: Touchscreen.

Adjusting Setpoint - The default display will show the current temperature value for the space. Use the scroll button to index through additional sensor parameters. Parameters with the SETPOINT icon displayed above the temperature display are adjustable. Use the Up/Down buttons to adjust the setpoint, and use the scroll button to view the next parameter or return to the normal display mode.

Up/Down Button Function - The Up/Down buttons are used to adjust editable parameters including the temperature setpoint.

Override Button Function - The display shows a person in the lower left corner of the display at all times. If the person is solid, the unit is operating in occupied mode. If it is an outline of the person, the unit is in unoccupied mode. Pushing the Override button when the unit is in unoccupied mode temporarily overrides the sequence to Occupied mode for a period of 1 to 4 hours (adjustable at the unit microprocessor).

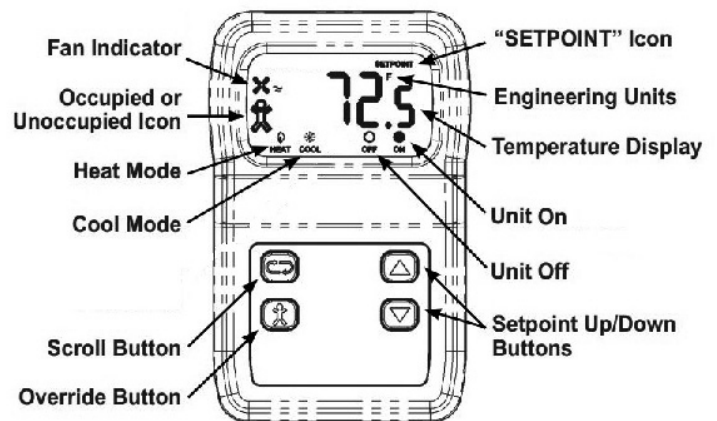

Initial Setup and Communication Configuration

The space thermostat is a Modbus connected device. Up to three additional Modbus sensors can be added for space temperature averaging. The sensors must all be connected in a daisy chain configuration.

If space temperature averaging is desired, additional field setup will be required both in the controller and on the Modbus space sensors:



- Each space sensor must have the DIP switches adjusted on the back of the sensor to the corresponding switches. Reference Space Thermostat Modbus Address chart on the following page for DIP switches settings.
- Once the address is set and the wires are connected the “Status” LED should be a steady green and the “Network” LED should be a quick blinking amber/green color
- To add additional sensors in the field, enter the Ctrl Variables Menu/Temperature and scroll down in the Temperature Menu to select Space Thermostat. Choose the number of space sensor being used (1-4).

Appendix C: Space Thermostat Quick Start



Status LED

Green indicates that the unit is operating properly.
Red indicates that there is a problem with the unit.

Terminal	Description
GND	Power Supply Ground (common to the controller)
Net B	RS485 network connection (Data -)
Net A	RS485 network connection (Data +)
Power	Power supply hot

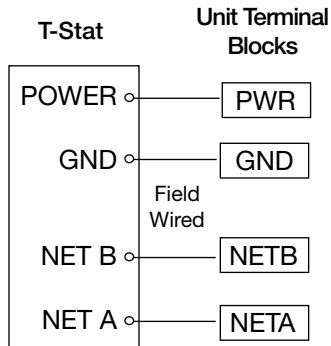

Note: Additional T-Stats should be daisy chained - do not make home runs back to the unit's terminal block nor the main controller.

Network LED

Flashing Red Slowly indicates that there has been no communications for 60 seconds.
Flashing Green Slowly indicates that there have been normal communications within the last 60 seconds.
Flashing Green Slowly with Quick Red Flashes; the quick red flashes indicate active communications.

Space Thermostat Modbus Address

	T-Stat 1 (Display)	T-Stat 2	T-Stat 3	T-Stat 4
Address in Microprocessor	10	11	12	13
Dip Switch Set on Stat	Sw 2 + Sw 8	Sw 1 + Sw 2 + Sw 8	Sw 4 + Sw 8	Sw 1 + Sw 4

Note: If touchscreen provided, then the touchscreen will take the place of T-Stat 1. The touchscreen is addressed in factory. For additional space thermostats, start with T-Stat 2 for addressing. Reference Appendix D: Touchscreen.

Baud Rate Setting

In order for the space thermostat to communicate with the microprocessor, the correct baud rate must be set in the space thermostat. To set the baud rate:

- The “PROG” DIP switch on the back of the space thermostat must be flipped to the right side.
- Use the Setpoint Down button to display P11 on the space thermostat.
- Push the Scroll button and use the Setpoint Up/Down buttons to adjust the baud rate to 192.
- Once 192 is displayed, push the Scroll button again to save the setting. Once the setting is saved, P11 should appear on the display.
- Flip the “PROG” DIP switch on the back of the space thermostat back to the left. The space thermostat should communicate and be set back to normal mode.

Appendix D: Touchscreen (pGDx)

The touchscreen (pGDx) is a remote mounted, graphical display terminal that communicates with the main unit controller. An embedded space temperature sensor allows the touchscreen to be the first space thermostat as well as monitor and adjust select parameters at the unit-mounted controller.

Unit Controller Parameters	
Monitor and Adjust at Touchscreen	Monitor at Touchscreen
Disable/Enable Unit	Unit Status
Temperature Setpoints	Space Temperature
Heating and Cooling Lockout Setpoint	Supply Temperature
Occupancy Control Mode	Outside Air Temperature
Temperature Control Mode	Space Static Pressure Setpoint
Heat & Vent Winter and Summer Modes	Space Static Pressure
Occupancy Override	Unit Sales Order Number
Reset Active Alarms (command only)	Active Alarms

Reference Sequence of Operation for additional information on the controller parameters.

Initial Setup and Communication Configuration

The touchscreen communicates via Modbus with the unit and should be installed in the space controlled by that unit. Up to three additional Modbus Space Thermostats may be added for space temperature averaging. The thermostats must all be connected in a daisy chain configuration - do not wire additional thermostats directly back to the unit's terminal block. Reference the unit's schematics and Appendix F: Factory Modbus Connections for more information.



pGDx Specifications

Power Supply	Power supplied from unit controller. Reference pGDx cutsheet and unit schematics.
Cable Requirements – RS485	Shielded twisted pair cable AWG 20-22 Max distance of 500 meters

The microprocessor controller will be pre-configured for the touchscreen space thermostat. For space temperature averaging, reference Appendix C: Space Thermostat Quick Start Guide for more information.

The touchscreen has multiple mounting options (i.e. surface, recessed and steel beam mounts). Reference the mounting instructions shipped with the touchscreen before installation.

Touchscreen Interface Use

The touchscreen is a touch interface. Utilize the on-screen buttons to navigate the touchscreen. The buttons available will change from screen to screen. The following common buttons may be on the top bar of the screen.

Top Bar Buttons	
Symbol	Description
	Touchscreen is not communicating with the unit's controller. Press to show Communication Error Message.
	Login required to access settings per password strictness level. Press to login.
	Password has already been entered and login not required at this time. Press to logout.
	Allows screen to be locked for 60 seconds for dusting so that buttons are not pressed inadvertently. Press to lock screen.
	Press to navigate to Settings Menu.
	Press to navigate to Previous Screen.
	Press to navigate to Home Screen.

Appendix D: Touchscreen (pGDx)

Touchscreen Menu Navigation

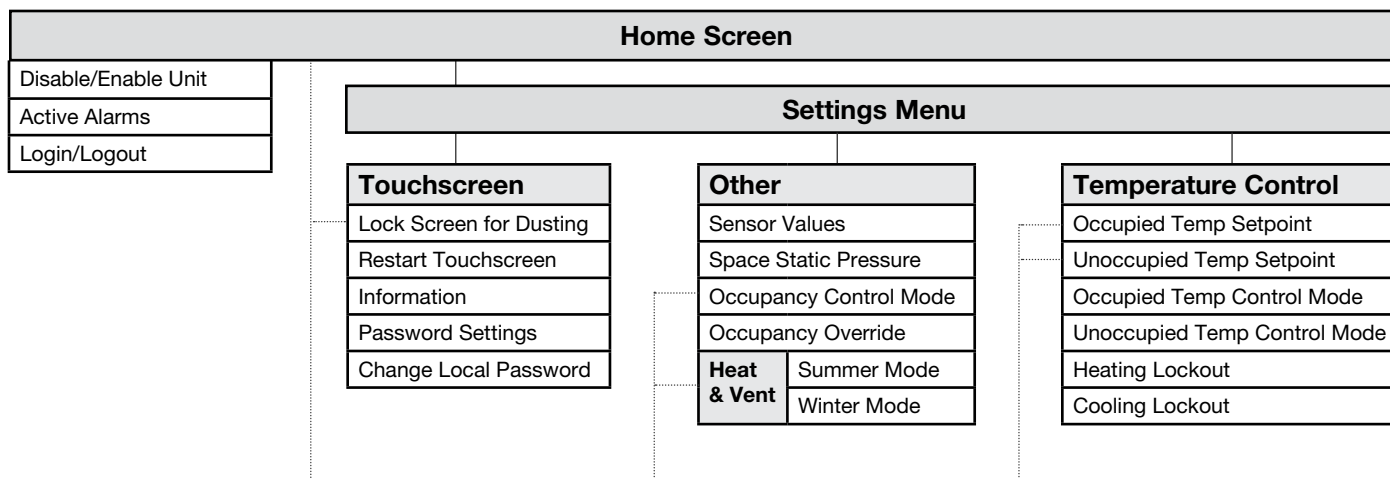

Notes:

1. Some options may not show dependent on the unit's controller configuration/settings.
2. Dotted lines indicate another navigation path to that screen

Overview of Screens

Home Screen

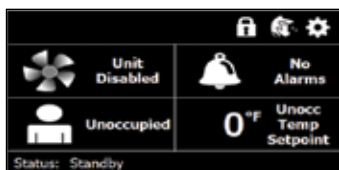

The home screen is for touchscreen navigation and viewing unit status. The touchscreen will default to the home screen after inactivity.

The following table explains each area and that area's button action.

Home Screen		
Area	Button Press Action	Description
Unit Disable / Enable	Disable or enable the unit.	Text/color indicates if unit is disabled (white) or enabled (green). The fan is animated to spin when the supply fan is on.
Alarms	Navigates to the Active Alarms screen.	Text/Color indicates if there are active alarms (red) or no active alarms (white).
Occupancy	Navigates to the Occupancy Control Mode Screen.	Text indicates occupancy status (occupied or unoccupied).
Heat & Vent is installed	Navigates to the Heat & Vent menu.	Text indicates occupancy status (occupied or unoccupied) and active Heat & Vent mode (summer or winter).
Temp Setpoint	Navigates to Unocc (or Occ) Temp Setpoint Screen.	If unoccupied, displays the unoccupied temperature setpoint. If occupied, displays the occupied temperature setpoint.
Status	None	Displays the status of the unit.



COMMUNICATION ERROR

When the touchscreen is not communicating with the unit controller, the yellow communication error icon will show in the top bar and the communication error message will pop-up. The message may be closed by pressing "Ok" but the icon will show until communication is re-established.

Appendix D: Touchscreen (pGDx)



LOGINS

Login is required to view and/or edit some settings – reference Password Settings. Use the service password (1000) or the touchscreen local password - reference Change Local Password.

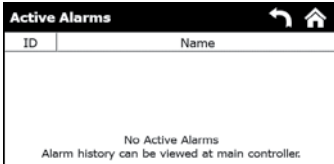

ACTIVE ALARMS

The Active Alarms screen will show the unit’s active alarms. When there are active alarms, a “Reset Alarms” button will show that may be pressed to reset all active alarms.

Settings Menu

The Settings Menu allows the user to navigate the settings/setpoints available to the user on the touchscreen. The following buttons will be seen on some of the screens.

Settings Screen Buttons	
Symbol	Press Action
	Cancel and navigate to previous screen.
	Changes the mode. Press “Set” to apply change.
	Changes the setpoint. Press “Set” to apply change.
	Applies change shown on the screen and navigates to the previous screen.
	Navigates to information relevant to current screen.

Touchscreen Settings

The Touchscreen Settings Menu allows the user to navigate settings specific to the touchscreen:



- Lock Screen for Dusting
- Restart Touchscreen
- Information (Unit and Touchscreen)
- Password Settings
- Change Local Password



LOCK SCREEN FOR DUSTING

Locking the screen allows the user to dust the screen without inadvertently pressing buttons. When the touchscreen is locked for dusting, a 60 second countdown will show on the screen. When the touchscreen unlocks, the home screen will show.

The factory password is required to access **Password Settings** and **Change Local Password**.



PASSWORD SETTINGS

There are three password strictness levels: low, standard, and high. Reference the following table for details on each level.

The touchscreen from factory will be set to a “low” level. Use the low, standard, and high buttons to change the level.

Password Strictness Level

	View Home Screen	Enable/Disable Unit	Rest Alarms	Change Settings/ Setpoints
Low	X	X	X	X
Standard	X	X	X	
High (View Only)	X			

Notes:

1. Password not needed for items with “x” in cell.
2. The touchscreen passwords are intended for user friendliness because the touchscreen is installed in the space. Everything that can be changed/viewed from the unit’s controller on the touchscreen, may be changed/viewed on the unit’s controller without a password.
3. Factory password is always required to access and change password settings.

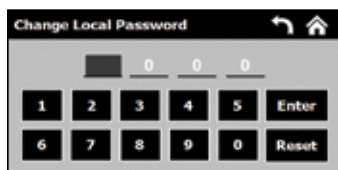

CHANGE LOCAL PASSWORD

The touchscreen local password is set to **1290** from factory. This may be changed to any 4-digit number.

Other settings

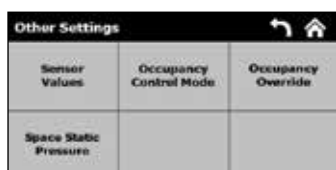

The Other Settings Menu allows the user to navigate additional parameters:

- Sensor Values
- Occupancy Control Mode
- Occupancy Override or Heat & Vent
- Space Static Pressure

Other Settings

Screens	Description
Sensor Values	View the Space, Supply and Outdoor Air temperatures.
Occupancy Control Mode	Change the Occupancy Control Mode.
Occupancy Override	Override Occupancy for a set duration as set on the main controller.
Heat & Vent	Change Summer and Winter operation selections for Heat and Vent.
Space Static Pressure	View the Space Static Pressure Setpoint and Space Static Pressure. The setpoint may not be adjusted on the touchscreen.

Heat & Vent Settings

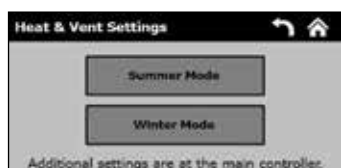

The Heat & Vent Settings Menu allows the user to navigate Heat & Vent parameters:

- Summer Mode
- Winter Mode

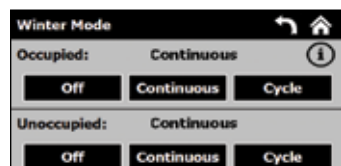

WINTER AND SUMMER MODE

Change occupied and unoccupied modes. Use the Off, Continuous and Cycle buttons to change the level.

Temp Control Settings

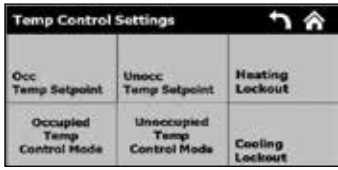

The Temp Control Settings menu allows the user to navigate to temperature parameters screens to adjust setpoints/modes:

- Occupied Temperature Setpoints
- Unoccupied Temperature Setpoints
- Heating Lockout
- Cooling Lockout
- Occupied Temperature Control Mode
- Unoccupied Temperature Control Mode



Appendix E: Points List

Variable	Description	BACnet	Modbus	Read or Write	Text or Unit of M	
		Object	Register		Active	Inactive
Space_Temp_Analog_Input	Space Temperature	AI-1	30002	R	°F	
Supply_Temp_Analog_Input	Supply Temperature	AI-2	30004	R	°F	
Outside_Air_Temp_Analog_Input	Outside Air Temperature	AI-3	30006	R	°F	
Space_RH_Analog_Input	Space % Relative Humidity	AI-6	30012	R	%RH	
Space_Static_Pressure_Analog_Input	Space Static Pressure	AI-9	30018	R	"wc	
Supply_Duct_Static_Pressure_Analog_Input	Supply Duct Static Pressure	AI-10	30020	R	"wc	
Space_CO2_1_Analog_Input	Space CO2 ppm	AI-11	30022	R	ppm	
Return_CO2_Analog_Input	Return CO2 ppm	AI-12	30024	R	ppm	
Aux_In_Customer_1	Customer defined auxiliary input	AI-22	30044	R	selectable	
Aux_In_Customer_2	Customer defined auxiliary input	AI-23	30046	R	selectable	
Aux_In_Customer_3	Customer defined auxiliary input	AI-24	30048	R	selectable	
Aux_In_Customer_4	Customer defined auxiliary input	AI-25	30050	R	selectable	
Aux_In_Customer_5	Customer defined auxiliary input	AI-26	30052	R	selectable	
Aux_In_Customer_6	Customer defined auxiliary input	AI-27	30054	R	selectable	
Aux_In_Customer_7	Customer defined auxiliary input	AI-28	30056	R	selectable	
Aux_In_Customer_8	Customer defined auxiliary input	AI-29	30058	R	selectable	
Aux_In_Customer_9	Customer defined auxiliary input	AI-30	30060	R	selectable	
Aux_In_Customer_10	Customer defined auxiliary input	AI-31	30062	R	selectable	
Temperature_Setpoint	Occupied Temperature Setpoint	AV-1	40002	R/W	°F	
Temperature_Heat_Cool_Deadband	Occupied Spt Deadband - Space/Return Reset	AV-2	40004	R/W	Δ°F	
Temperature_Setpoint_Unoccupied	Unoccupied Temperature Setpoint	AV-3	40006	R/W	°F	
Temperature_Heat_Cool_Deadband_Unoccupied	Unoccupied Spt Deadband - Space/Return Reset	AV-4	40008	R/W	Δ°F	
Supply_Temperature_Minimum_Cooling_Setpoint	Minimum supply air temperature - Cooling	AV-5	40010	R/W	°F	
Supply_Temperature_Maximum_Cooling_Setpoint	Maximum supply air temperature - Cooling	AV-6	40012	R/W	°F	
Supply_Temperature_Minimum_Heating_Setpoint	Minimum supply air temperature - Heating	AV-7	40014	R/W	°F	

Appendix E: Points List

Variable	Description	BACnet	Modbus	Read or Write	Text or Unit of M	
		Object	Register		Active	Inactive
Supply_Temperature_Maximum_Heating_Setpoint	Maximum supply air temperature - Heating	AV-8	40016	R/W	°F	
Economizer_Temp_Enable_Setpoint	Economizer Ambient Temp Enable Setpoint	AV-9	40018	R/W	°F	
Cooling_Lockout_Setpoint	Cooling Ambient Lockout Setpoint	AV-13	40026	R/W	°F	
Heating_Lockout_Setpoint	Heating Ambient Lockout Setpoint	AV-14	40028	R/W	°F	
Economizer_Lockout_Setpoint	Economizer Lockout Setpoint	AV-15	40030	R/W	°F	
Space_Static_Pressure_Setpoint	Space Static Pressure Setpoint	AV-16	40032	R/W	"wc	
Supply_Duct_Static_Pressure_Setpoint	Supply Duct Static Pressure Setpoint	AV-17	40034	R/W	"wc	
Space_CO2_Setpoint	Space CO2 Setpoint	AV-18	40036	R/W	ppm	
Outside_Air_Damper_Minimum_Setpoint_Occ	Occupied Outside Air Damper Min Setpoint	AV-19	40038	R/W	%	
Outside_Air_Damper_Minimum_Setpoint_Unocc	Unoccupied Outside Air Damper Min Setpoint	AV-20	40040	R/W	%	
Heat_Vent_Changeover_Temp	Heat Vent Changeover Setpoint	AV-21	40042	R/W	°F	
Heat_Vent_Changeover_Hysteresis	Heat Vent Changeover Hysteresis (Summer Only)	AV-22	40044	R/W	°F	
HV_Summer_Damper_Setpoint_Occ	Occupied OAD Setpoint when in Summer Mode	AV-23	40046	R/W	%	
HV_Summer_Damper_Setpoint_Unocc	Unoccupied OAD Setpoint when in Summer Mode	AV-24	40048	R/W	%	
HV_Summer_Lockout	Summer Mode Ambient Lockout Setpoint	AV-25	40050	R/W	°F	
HV_Winter_Damper_Setpoint_Occ	Occupied OAD Setpoint when in Winter Mode	AV-26	40052	R/W	%	
HV_Winter_Damper_Setpoint_Unocc	Unoccupied OAD Setpoint when in Winter Mode	AV-27	40054	R/W	%	
Supply_Air_Low_Limit_Setpoint	Low Supply Temp resulting in unit shutdown	AV-28	40056	R/W	°F	
Outside_Temp_from_BMS	Outside Temp from BMS. (Source set to BMS)	AV-30	40060	R/W	°F	
Space_1_CO2_from_BMS	Space CO2 from BMS - source is BMS	AV-33	40066	R/W	ppm	
Return_CO2_from_BMS	Return CO2 from BMS - source is BMS	AV-34	40068	R/W	ppm	
Space_Static_from_BMS	Space Static from BMS - source is BMS	AV-36	40072	R/W	"wc	
Space_Temp_from_BMS	Space Temp from BMS - source is BMS	AV-37	40074	R/W	°F	
SF_Control_Signal_BMS	BMS to control signal for supply fan speed	AV-38	40076	R/W	%	
OAD_Control_Signal_BMS	Allows the BMS to control OAD position	AV-39	40078	R/W	%	

Appendix E: Points List

Variable	Description	BACnet	Modbus	Read or Write	Text or Unit of M	
		Object	Register		Active	Inactive
Aux_BMS_Analog_Output_1	BMS Commanded auxiliary analog output	AV-40	40080	R/W	selectable	
Unit_Status_Mode	Unit Status Mode - See Table	AV-41	30064	R	Real	
Supply_Temperature_Calculated_Setpoint	Active Supply Temperature Setpoint	AV-42	30066	R	°F	
Cooling_1_Ramp_Capacity	Cooling Ramp 1 Status Value	AV-43	30068	R	%	
Economizer_Ramp	Economizer Ramp	AV-44	30070	R	%	
Heating_Capacity	Heating Ramp	AV-46	30074	R	%	
OAD_CFM_BMS	OAD CFM	AV-56	30094	R	cfm	
Active_Temperature_Setpoint	Active Temperature Setpoint	AV-57	30096	R	°F	
Chilled_Water_1_Valve_Analog_Output	Chilled Water 1 Valve Analog Output	AV-58	30098	R	%	
Electric_Heater_1_Analog_Output	Electric Heater 1 Analog Output	AV-59	30100	R	%	
Hot_Water_Valve_1_Analog_Output	Hot Water Valve 1 Analog Output	AV-60	30102	R	%	
Mod_Gas_Furnace_1_Analog_Output	Mod Gas Furnace 1 Analog Output	AV-61	30104	R	%	
Outside_Airflow_Mask	Percentage of Outside Airflow	AV-62	30106	R	%	
Supply_Fan_Speed_Analog_Output	Supply Fan Speed Analog Output	AV-63	30108	R	%	
Modulating_Compressor_Analog_Output_BMS	Modulating Compressor Analog Output	AV-64	30110	R	%	
Active_Cooling_Setpoint	Active Cooling Setpoint - Unoccupied	AV-69	30120	R	°F	
Active_Heating_Setpoint	Active Heating Setpoint - Unoccupied	AV-70	30122	R	°F	
LatestAlm_Real	Most recent alarm - See Alarm Table	AV-71	30156	R	Integer	
Digital_Output_Word_Real_1	Digital Output Word - See Table	AV-72	30158	R	Bit Pack	
Digital_Output_Word_Real_2	Digital Output Word - See Table	AV-73	30160	R	Bit Pack	
Cooling_Alarm_Word_Real_1	Cooling Alarm Word - See Table	AV-74	30162	R	Bit Pack	
Cooling_Alarm_Word_Real_2	Cooling Alarm Word - See Table	AV-75	30164	R	Bit Pack	
Device_Offline_Word_Real_1	Device Offline Word - See Table	AV-76	30166	R	Bit Pack	
Device_Offline_Word_Real_2	Device Offline Word - See Table	AV-77	30168	R	Bit Pack	
Device_Alarm_Word_Real_1	Device Alarm Word - See Table	AV-78	30170	R	Bit Pack	

Appendix E: Points List

Variable	Description	BACnet	Modbus	Read or Write	Text or Unit of M	
		Object	Register		Active	Inactive
Device_Alarm_Word_Real_2	Device Alarm Word - See Table	AV-79	30172	R	Bit Pack	
Heating_Alarm_Word_Real_1	Heating Alarm Word - See Table	AV-80	30174	R	Bit Pack	
Heating_Alarm_Word_Real_2	Heating Alarm Word - See Table	AV-81	30176	R	Bit Pack	
Unit_Status_Word_Real_1	Unit Status Word - See Table	AV-82	30178	R	Bit Pack	
Unit_Status_Word_Real_2	Unit Status Word - See Table	AV-83	30180	R	Bit Pack	
Exhaust_Fan_1_Status_Digital_Input	Exhaust Fan Status	BI-1	10005	R	Active	Inactive
Supply_Fan_1_Status_Digital_Input	Supply Fan Status	BI-2	10006	R	Active	Inactive
BMS_Watchdog	BMS Watchdog command Used to determine BMS comm status	BV-1	1	R/W	Active	Inactive
System_Enable	Master system enable/disable point	BV-2	2	R/W	Active	Inactive
BMS_Occupancy_Command	Occupancy Command	BV-3	3	R/W	Unoccupied	Occupied
Reset_All_Alarms	Alarm Reset Command	BV-4	4	R/W	Reset	Normal
Outside_Temp_Source_BMS	Outside Temp Source Selection	BV-6	6	R/W	BMS	Local
Space_1_CO2_Source_BMS	Space CO2 Source Selection	BV-9	9	R/W	BMS	Local
Return_CO2_Source_BMS	Return CO2 Source Selection	BV-10	10	R/W	BMS	Local
Space_Static_Source_BMS	Space Static Source Selection	BV-12	12	R/W	BMS	Local
Space_Temp_Source_BMS	Space Temp Source Selection	BV-13	13	R/W	BMS	Local
SF_Control_Source_BMS	Allows the BMS to control supply fan speed	BV-14	14	R/W	BMS	Local
OAD_Control_Source_BMS	Allows the BMS to control OAD position	BV-15	15	R/W	BMS	Local
Aux_BMS_Digital_Output_1	BMS Commanded auxiliary digital output	BV-16	16	R/W	Active	Inactive
Aux_BMS_Digital_Output_2	BMS Commanded auxiliary digital output	BV-17	17	R/W	Active	Inactive
Occupied	Occupancy	BV-18	10001	R	Occupied	Unoccupied
Global_Alarm	Alarm Output - Any or Shutdown Selectable	BV-19	10002	R	Alarm	Normal
BMS_Watchdog_Active	Status of the BMS Watchdog Ping	BV-20	10003	R	Active	Inactive
Heat_Vent_Mode_Active	Current Heat Vent Mode	BV-21	10004	R	Summer	Winter
Supply_Fan_1_Alarm.Active	Supply Fan Alarm Active	BV-22	10007	R	Alarm	Normal

Appendix E: Points List

Variable	Description	BACnet	Modbus	Read or Write	Text or Unit of M	
		Object	Register		Active	Inactive
Exhaust_Fan_1_Alarm.Active	Exhaust Fan Alarm Active	BV-23	10008	R	Alarm	Normal
Fire_Safety_Shutdown_Alarm.Active	Fire Safety Alarm Active	BV-25	10010	R	Alarm	Normal
Refrigerant_Leak_Alarm.Active	Refrigerant Leak Alarm Active	BV-26	10011	R	Alarm	Normal
Temperature_Reset_Mode	Occupied Reset Mode	IV-1	40082	R	1-Discharge; 2-Space; 3-Return; 4-Outside	
Temperature_Reset_Mode_Unoccupied	Unoccupied Reset Mode	IV-2	40084	R	1-Discharge; 2-Space; 3-Return	
HV_Summer_Operation_Occ	Heat Vent Summer Operation Occupied	IV-3	40086	R	1-Off; 2-Continuous	
HV_Summer_Operation_Unocc	Heat Vent Summer Operation Unoccupied	IV-4	40088	R		
HV_Winter_Operation_Occ	Heat Vent Winter Operation Occupied	IV-5	40090	R	1-Off; 2-Continuous; 3-Cycle	
HV_Winter_Operation_Unocc	Heat Vent Winter Operation Unoccupied	IV-6	40092	R		
Active_Temperature_Reset_Mode	Active Occupied Reset Type Setpoint	IV-7	30124	R	1-Discharge; 2-Space; 3-Return; 4-Outside	
Active_Temperature_Reset_Mode_Unocc	Active Unoccupied Reset Type Setpoint	IV-8	30126	R	1-Discharge; 2-Space; 3-Return	
LatestAlm	Most recent alarm - See Alarm Table	IV-9	30128	R	Integer	
Digital_Output_Word	Digital Output Word - See Table	IV-10	30132	R	Bit Pack	
Cooling_Alarm_Word	Cooling Alarm Word - See Table	IV-11	30136	R	Bit Pack	
Device_Offline_Word	Device Offline Word - See Table	IV-12	30140	R	Bit Pack	
Device_Alarm_Word	Device Alarm Word - See Table	IV-13	30144	R	Bit Pack	
Heating_Alarm_Word	Heating Alarm Word - See Table	IV-14	30148	R	Bit Pack	
Unit_Status_Word	Unit Status Word - See Table	IV-15	30152	R	Bit Pack	

Appendix E: Points List

Digital Output Word Table (IV-10 / AV-72 & AV-73)

IV	IV Bit	AV	AV Bit	Bit Description	IV	IV Bit	AV	AV Bit	Bit Description
10	0	72	0	Supply Fan Start	10	16	73	0	Evaporative Cooling Valve Enable
	1		1	Exhaust Fan Start		17		1	Evaporative Cooling Pump Enable
	2		2	Exhaust Relief Enable		18		2	
	3		3	Compressor 1 Start		19		3	
	4		4	Compressor 2 Start		20		4	
	5		5	Condenser Fan Start		21		5	
	6		6			22		6	
	7		7	Furnace 1 Start		23		7	
	8		8	Furnace 1 Stage 2 Start		24		8	
	9		9	Furnace 2 Start		25		9	
	10		10	Furnace 2 Stage 2 Start		26		10	
	11		11	Furnace 3 Start		27		11	
	12		12			28		12	
	13		13	Damper Acuator Power Enable		29		13	
	14		14	Direct Gas Start		30		14	
15	15	Electric Heat Start	31	15					

Cooling Alarm Word Table (IV-11 / AV-74 & AV-75)

IV	IV Bit	AV	AV Bit	Bit Description	IV	IV Bit	AV	AV Bit	Bit Description
11	0	74	0	Circuit A High Low Pressure Switch Alarm	11	16	75	0	
	1		1	Circuit B High Low Pressure Switch Alarm		17		1	
	2		2			18		2	
	3		3			19		3	
	4		4			20		4	
	5		5			21		5	
	6		6			22		6	
	7		7			23		7	
	8		8			24		8	
	9		9			25		9	
	10		10			26		10	
	11		11			27		11	
	12		12			28		12	
	13		13			29		13	
	14		14			30		14	
15	15		31	15					

Appendix E: Points List

Device Offline Word Table (IV-12 / AV-76 & AV-77)

IV	IV Bit	AV	AV Bit	Bit Description	IV	IV Bit	AV	AV Bit	Bit Description
12	0	76	0	Space TStat 1 Offline	12	16	77	0	
	1		1	Space TStat 2 Offline		17		1	
	2		2	Space TStat 3 Offline		18		2	
	3		3	Space TStat 4 Offline		19		3	
	4		4	Expansion Board 1 Offline (IG 1 Furnace)		20		4	
	5		5	Expansion Board 2 Offline (IG 2 & 3 Furnace)		21		5	
	6		6	Expansion Board 3 Offline (Cooling)		22		6	
	7		7	Greentrol Outside Air Offline		23		7	
	8		8	BMS Offline Alarm		24		8	
	9		9	Permanent Memory - Too Many Writes		25		9	
	10		10	Touchscreen Offline		26		10	
	11		11			27		11	Primary Unit Offline
	12		12			28		12	Secondary Unit Offline - Unit 1
	13		13			29		13	Secondary Unit Offline - Unit 2
	14		14			30		14	Secondary Unit Offline - Unit 3
15	15		31	15	Secondary Unit Offline - Unit 4				

Device Alarm Word Table (IV-13 / AV-78 & AV-79)

IV	IV Bit	AV	AV Bit	Bit Description	IV	IV Bit	AV	AV Bit	Bit Description
13	0	78	0	Supply Fan Alarm	13	16	79	0	
	1		1	Exhaust Fan Alarm		17		1	Shutdown Input Alarm
	2		2	Drain Pan Alarm		18		2	
	3		3	Filter Alarm		19		3	
	4		4	Greentrol OAD AFMS Alarm		20		4	
	5		5	Outside Air Temp Sensor Alarm		21		5	
	6		6	Space CO2 Sensor Alarm		22		6	
	7		7	Supply Air Temp Sensor Alarm		23		7	
	8		8	Space Temperature Sensor Alarm		24		8	
	9		9	Supply Temp Low Limit Alarm		25		9	
	10		10	Supply Temp High Limit Alarm		26		10	
	11		11	Supply High Duct Static Alarm		27		11	
	12		12	Supply Duct Static Sensor Alarm		28		12	
	13		13	Space Static Pressure Sensor Alarm		29		13	
	14		14	Space High Static Alarm		30		14	
15	15	Return CO2 Sensor Alarm	31	15					

Appendix E: Points List

Heating Alarm Word Table (IV-14 / AV-80 & AV-81)

IV	IV Bit	AV	AV Bit	Bit Description	IV	IV Bit	AV	AV Bit	Bit Description
14	0	80	0	DG Flame Safeguard General Reference	14	16	81	0	IG Furnace 1 Combustion Fan Alarm
	1		1	DG Flame Safeguard Manual Reset at FSG		17		1	IG Furnace 2-No Flame Alarm After 3 Tries
	2		2	DG Pilot Flame Alarm Did Not Prove		18		2	IG Furnace 2 Max Retries
	3		3	DG Heating Safety Check Circuit		19		3	IG Furnace 2 Ignition Controller Alarm
	4		4	DG Flame Safeguard Check Functionality		20		4	IG Furnace 3-No Flame Alarm After 3 Tries
	5		5	DG Burner Differential Check Pressure		21		5	IG Furnace 3 Max Retries
	6		6	General IG Furnace Alarm		22		6	IG Furnace 3 Ignition Controller Alarm
	7		7	IG Furnace 1 No flame Alarm After 3 Tries		23		7	
	8		8	IG Furnace 1 Large No Flame After 3 Tries		24		8	
	9		9	IG Furnace 1 Combust Fan High Pressure Sw		25		9	
	10		10	IG Furnace 1 Ignition Controller Alarm		26		10	
	11		11	IG Furnace 1 Pressure Switch Fault Alarm		27		11	
	12		12	IG Furnace 1 Combust Fan Proving Alarm		28		12	
	13		13	IG Furnace 1 Max Retries		29		13	
	14		14	IG Furnace 1 High Pressure Sw No Call for Heat		30		14	
15	15	IG Furnace 1 IC fault Check Furnace Wiring	31	15					

Unit Status Word Table (IV-15 / AV-82 & AV-83)

IV	IV Bit	AV	AV Bit	Bit Description	IV	IV Bit	AV	AV Bit	Bit Description
15	0	82	0	Standby	15	16	83	0	Unit Off Flow Active
	1		1	Occupied Start		17		1	Fans Only
	2		2	Unoccupied Start		18		2	Economizing
	3		3	Opening Dampers		19		3	
	4		4	Dampers Open		20		4	Cooling
	5		5	Fan Start Delay		21		5	Heating
	6		6	Exhaust Fan On		22		6	
	7		7	Supply Fan On		23		7	
	8		8	System On		24		8	
	9		9	Soft Shutdown		25		9	
	10		10	System Disabled		26		10	
	11		11	Remote Off (R to G)		27		11	Max Vent Active
	12		12	System Shutdown Alarm		28		12	Morning Warm Up/Cool Down Active
	13		13			29		13	Winter Ramp Active
	14		14			30		14	Occupancy Override
15	15		31	15	Overrides Active				

Appendix E: Points List

Unit Status Mode Table (AV-41)

0	Standby	14	System Shutdown Alarm
1	Unoccupied Start	18	Unit Off Flow Active
2	Occupied Start	19	Fans Only
3	Opening Dampers	20	Economizing
5	Dampers Open	21	Cooling
6	Fan Start Delay	22	Heating
7	Exhaust Fan Start	27	A2L Alarm Active
8	Supply Fan Start	30	Overrides
9	Startup Delay	31	Expansion Offline
10	System On	32	Occupancy Overridden
11	Soft Shutdown	33	Max Vent Sequence Active
12	System Disabled	35	Morning Warm Up/Cool Down Active (Sequence)
13	Remote Off (R to G)	36	Winter Ramp Active

LatestAlm Alarm Table (IV-9 / AV-71)

0	No Active Alarms	31	IG Furnace 1 Max Retries
1	Supply Fan Run Status Not Proven	32	IG Furnace 1 High PSW No Call for Heat
2	Exhaust Fan Run Status Not Proven	34	IG Furnace 1 IC Fault Check IC->pCOe Wiring
3	Filters are Dirty Replace Filters	35	IG Furnace 1 Combustion Fan Alarm
4	Cond Drain Pan Full Check Drain	37	IG Furnace 2 - No Flame Alarm After 3 Tries
5	High Supply Duct Static Pressure	38	IG Furnace 2 Max Retries
6	Outside Air Temp Sensor Value Not Valid	39	IG Furnace 2 Ignition Controller Alarm
7	Space Temperature Sensor Value Not Valid	40	IG Furnace 3 - No Flame Alarm After 3 Tries
8	Supply Air Temperature Sensor Value Not Valid	41	IG Furnace 3 Max Retries
9	Outside Air Greentrol Offline or Flow Error	42	IG Furnace 3 Ignition Controller Alarm
10	Hi/Low Pressure Switch Circuit A	43	DG Flame Safeguard General Reference
11	Hi/Low Pressure Switch Circuit B	44	DG Flame Safeguard Manual Reset at FSG
12	Space CO2 Sensor Value Not Valid	45	DG Pilot Flame Alarm Did Not Prove
13	Return CO2 Sensor Value Not Valid	46	DG Heating Safety Check Circuit
14	Space Static Pressure Sensor Value Not Valid	47	DG Flame Safeguard Check Functionality
15	Supply Duct Stat Press Sensor Value Not Valid	48	DG Burner Differential Check Pressure
16	Supply Air Temperature Low Limit Shutdown	51	Multi Devices per Ch Contact Tech Support
17	Supply Air Temperature High Limit Shutdown	52	Comp Maint Alarm Run Hours Spt Reached
18	Space High Static Pres Shutdown	54	BMS Frequent Writes Reduce Num of Writes
19	BMS Offline Watchdog is FALSE	56	Exp Board 1 Status Board is Offline
20	BACnet License Not Installed	57	Exp Board 2 Status Board is Offline
21	Space Thermostat 1 Sensor Offline	58	Exp Board 3 Status Board is Offline
22	Space Thermostat 2 Sensor Offline	59	Exp Board 4 Status Board is Offline
23	Space Thermostat 3 Sensor Offline	69	Secondary Unit Offline - Unit 1
24	Space Thermostat 4 Sensor Offline	70	Secondary Unit Offline - Unit 2
25	IG Furnace 1 - No Flame Alarm After 3 Tries	71	Secondary Unit Offline - Unit 3
26	IG Furnace 1 - Large No Flame After 3 Tries	72	Secondary Unit Offline - Unit 4
27	IG Furnace 1 Combust Fan High Pressure Sw	73	Primary Unit Offline
28	IG Furnace 1 Ignition Controller Alarm	135	Touchscreen Offline - Sensor Offline
29	IG Furnace 1 Pressure Switch Fault Alarm	136	Refriger Leak Detected - Mitigation Seq Active
30	IG Furnace 1 Combust Fan Proving Alarm	137	Fire Shutdown Alarm - Building Fire Alarm

BMS WATCHDOG

When directly commanding fans speeds, damper positions, or sending sensor values, the unit controller requires the BMS Watchdog point to be written to on a recurring basis. This tells the unit controller that the BMS is still actively communicating.

BMS Watchdog

The BMS Watchdog must be written to True (1) regularly to verify communication is established between the unit controller and the BMS headend system. If the BMS Watchdog value remains False(0) for longer than the Timeout Delay (15 minutes, adjustable), an alarm is generated and the controller falls back to local control and sensor values, as applicable, instead of using BMS commanded values.

Object	Variable	Description	Active Text	Inactive Text
BV-1	BMS_Watchdog	BMS Watchdog command	Active	Inactive
BV-20	BMS_Watchdog_Active	Status of the BMS watchdog ping.	Active	Inactive

Appendix F: Factory ModBus Connections

MODBUS CONNECTIONS

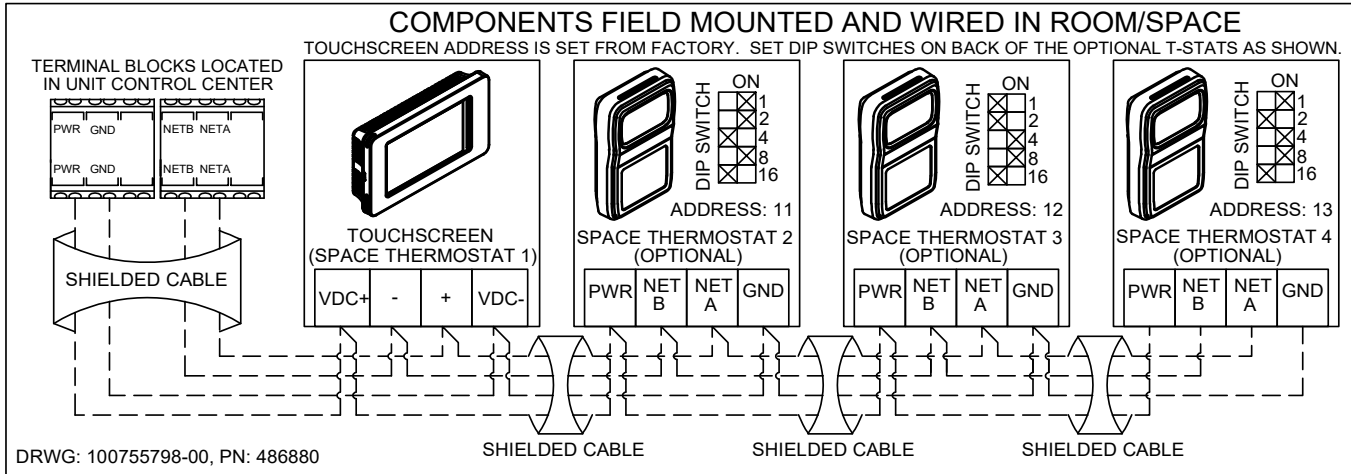

Appendix G: NTC Temperature Sensor Chart

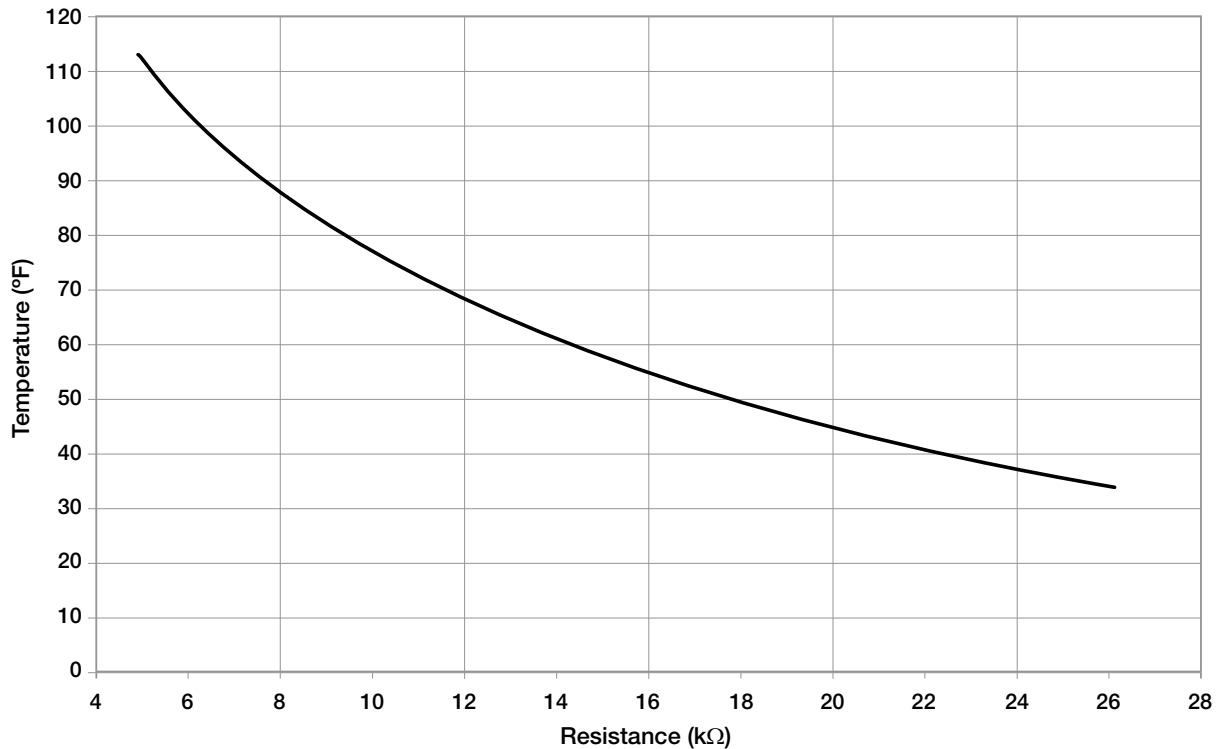

Appendix H: Refrigerant Leak Detection System

Units using R454B refrigerant are equipped with two sensors - one in the airstream and the other in the compressor cabinet - that can trigger a Refrigerant Leak Airstream alarm. The A2L sensors are normally-closed contacts with a 5 min reset delay, and an LED indicator on the back. When a leak is detected, the sensor contacts open which triggers electro-mechanical overrides, and a controller sequence mandated by UL60335-2-40.

If the controller receives a Fire Safety Shutdown Alarm signal, it will disable the unit and ignore electro-mechanical overrides for leak detection.

Refrigerant Leak Detected:

Refrigerant Leak Airstream Alarm signal is sent to the unit controller and terminals for the building to use. The following steps occur when this alarm is active:

- Unit is enabled.
- Occupancy status is changed to 'Occupied.'
- Compressors are disabled.
- If unit is equipped with direct gas heat, the heat is disabled.
- Damper is opened.
- Supply fan speed is adjusted to the minimum required supply air flow.
- Controller delays and system shutdown alarms are ignored.

An alarm notification will be sent to the building management system (BMS). When the alarm clears, devices and unit controller will return to normal operations. This sequence is required to reduce the leakage rate and safely dilute stagnant refrigerant in the unit.

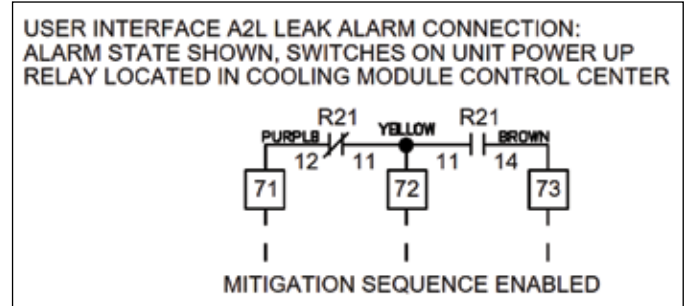

The terminals for Refrigerant alarms are provided as normally open or normally closed contacts for the building to use.

Below are the BMS Points available for Refrigerant Leak Detection:

Variable	Description	BACnet	Modbus	Read or Write	Text or Unit of M	
		Object	Register		Active	Inactive
Fire_Safety_Shutdown_Alarm.Active	Fire Safety Alarm Active	BV-25	10010	R	Alarm	Normal
Refrigerant_Leak_Alarm.Active	Refrigerant Leak Alarm Active	BV-26	10011	R	Alarm	Normal

Our Commitment

As a result of our commitment to continuous improvement, Greenheck reserves the right to change specifications without notice.

Specific Greenheck product warranties are located on greenheck.com within the product area tabs and in the Library under Warranties.

AMCA Publication 410-96, Safety Practices for Users and Installers of Industrial and Commercial Fans, provides additional safety information. This publication can be obtained from AMCA International, Inc. at www.amca.org.

