

Installation, Operation and Maintenance Manual

Please read and save these instructions for future reference. Read carefully before attempting to assemble, install, operate or maintain the product described. Protect yourself and others by observing all safety information. Failure to comply with these instructions will result in voiding of the product warranty and may result in personal injury and/or property damage.

Wind Load Table	
Design Pressure Rating	Maximum Single Section Size
+/- 150 PSF (7.2 kPa)	43 in. W x 144 in. H (1092 mm W x 3658 mm H)
+/- 130 (6.2 kPa)	49.5 in. W x 144 in. H (1257 mm W x 3658 mm H)
+/- 105 (5.0 kPa)	61.5 in. W x 144 in. H (1562 mm W x 3658 mm H)
+/- 90 (4.3 kPa)	72 in. W x 144 in. H (1829mm W x 3658 mm H)

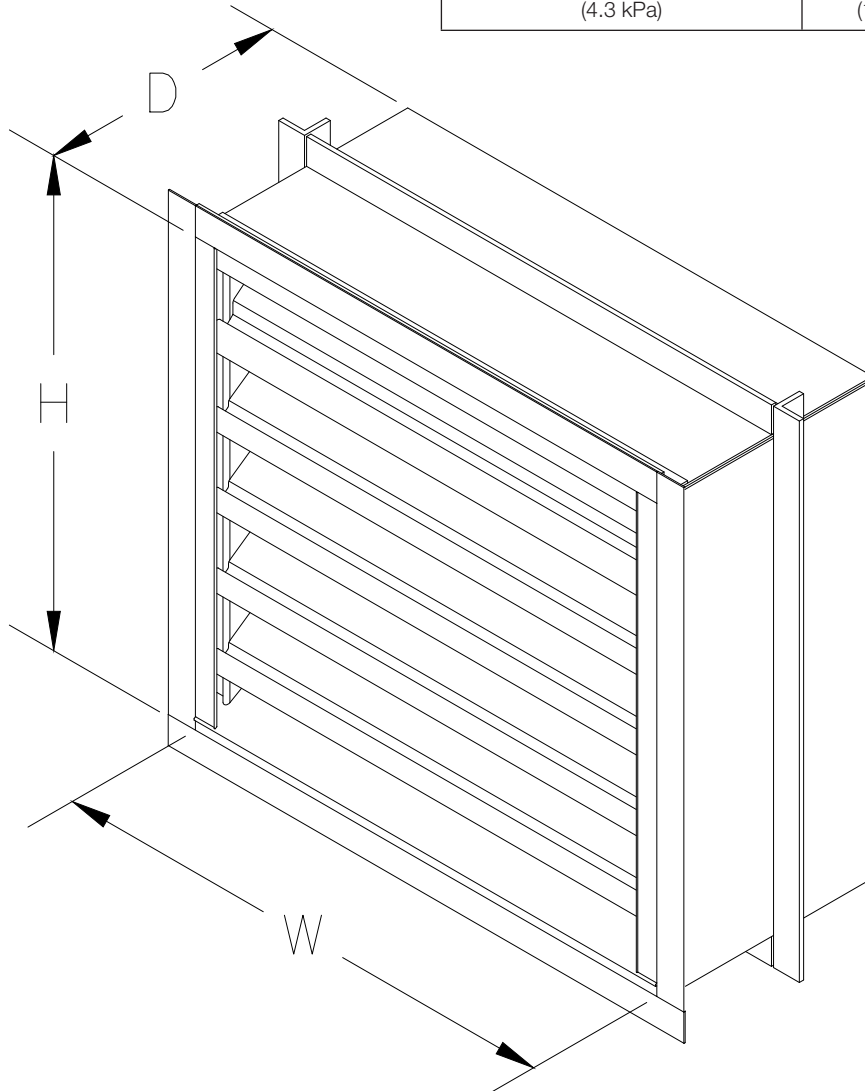

Maximum Size and Installation Information

Model K6746MD is a Miami-Dade Qualified and Florida Product Approved louver and must be installed in accordance with the installation instructions shown herein. Model K6746MD with Flange/Sleeve is qualified for installation into any substrate that can withstand the loads transferred to by the louver, including but not limited to concrete/masonry, aluminum, steel stud, and structural steel framed building conditions. Model K6746MD is structurally calculated to withstand positive and negative wind-loads up to 150 PSF (reference wind load table). The maximum single section rough opening width is 72.75 in. The maximum single section rough opening height is 144.50 in. While the maximum rough opening height is limited to 144.50 in., the rough opening width is limited to 1,000 in. as multiple sections may be installed side by side in accordance with installation instructions.

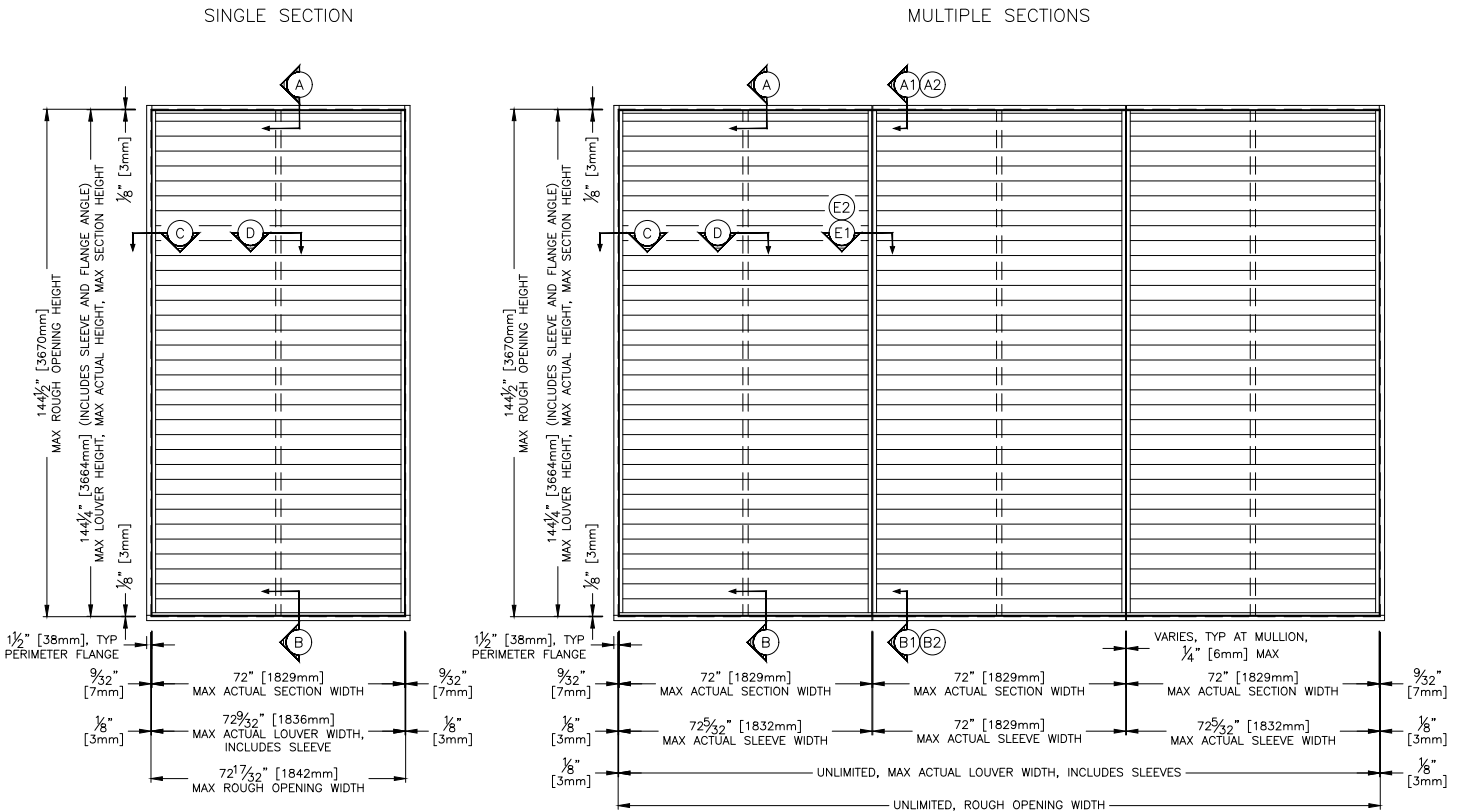

Minimum Rough Opening Size
 12 in. W x 12 in. H

Maximum Single Section Rough Opening Size
 72.75 in. W x 144.50 in. H

Building Condition/Substrate Limitations

Model K6746MD with Flange/Sleeve is qualified for installation into any substrate that can withstand the loads transferred to by the louver, including but not limited to concrete/masonry, aluminum, steel stud, and structural steel framed building conditions.

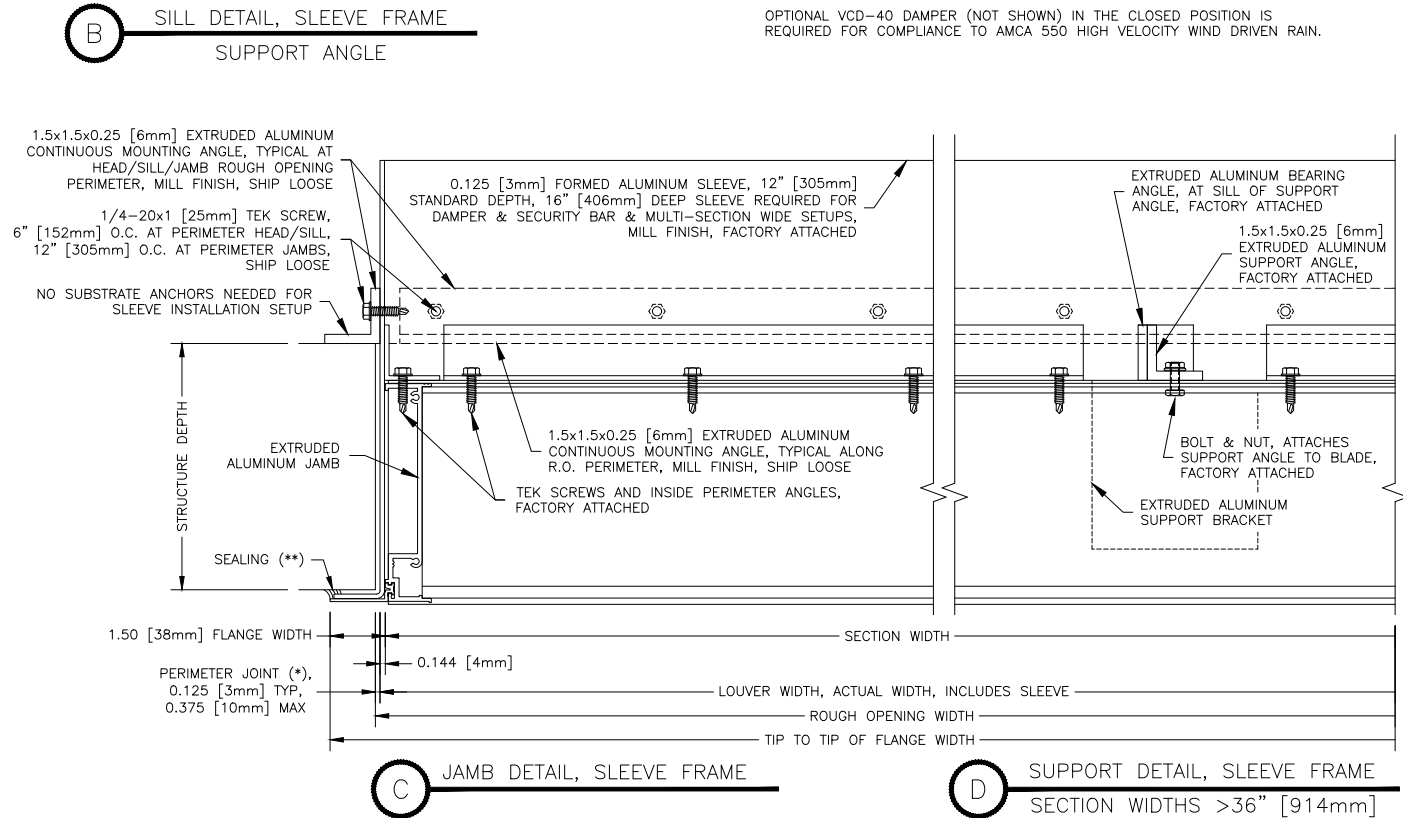
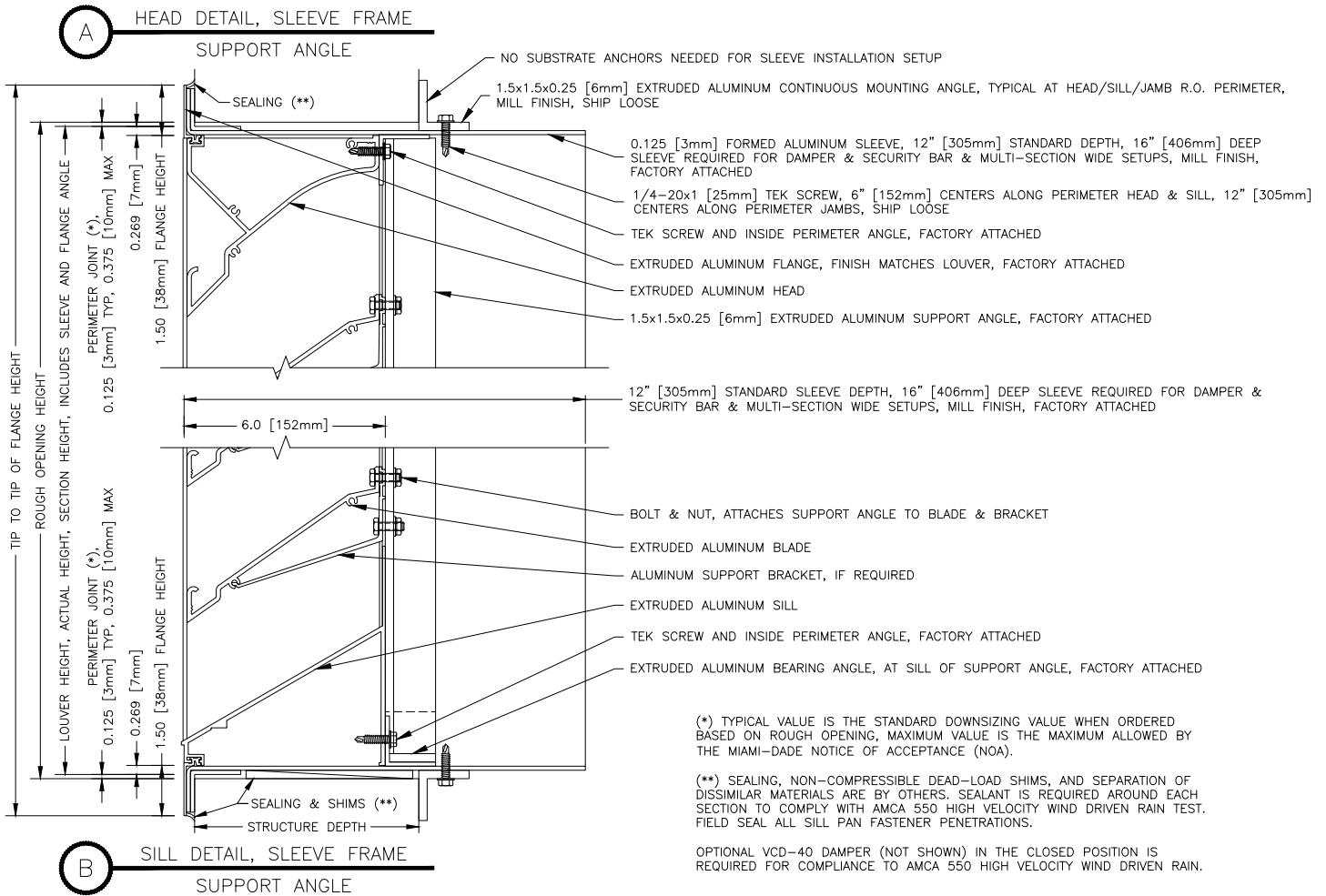

C JAMB DETAIL, SLEEVE FRAME

D SUPPORT DETAIL, SLEEVE FRAME
SECTION WIDTHS >36" [914mm]

A1 HEAD DETAIL, MULLION, SLEEVE FRAME

ROUGH OPENING HEIGHT $\leq 96.5"$ [2451mm]

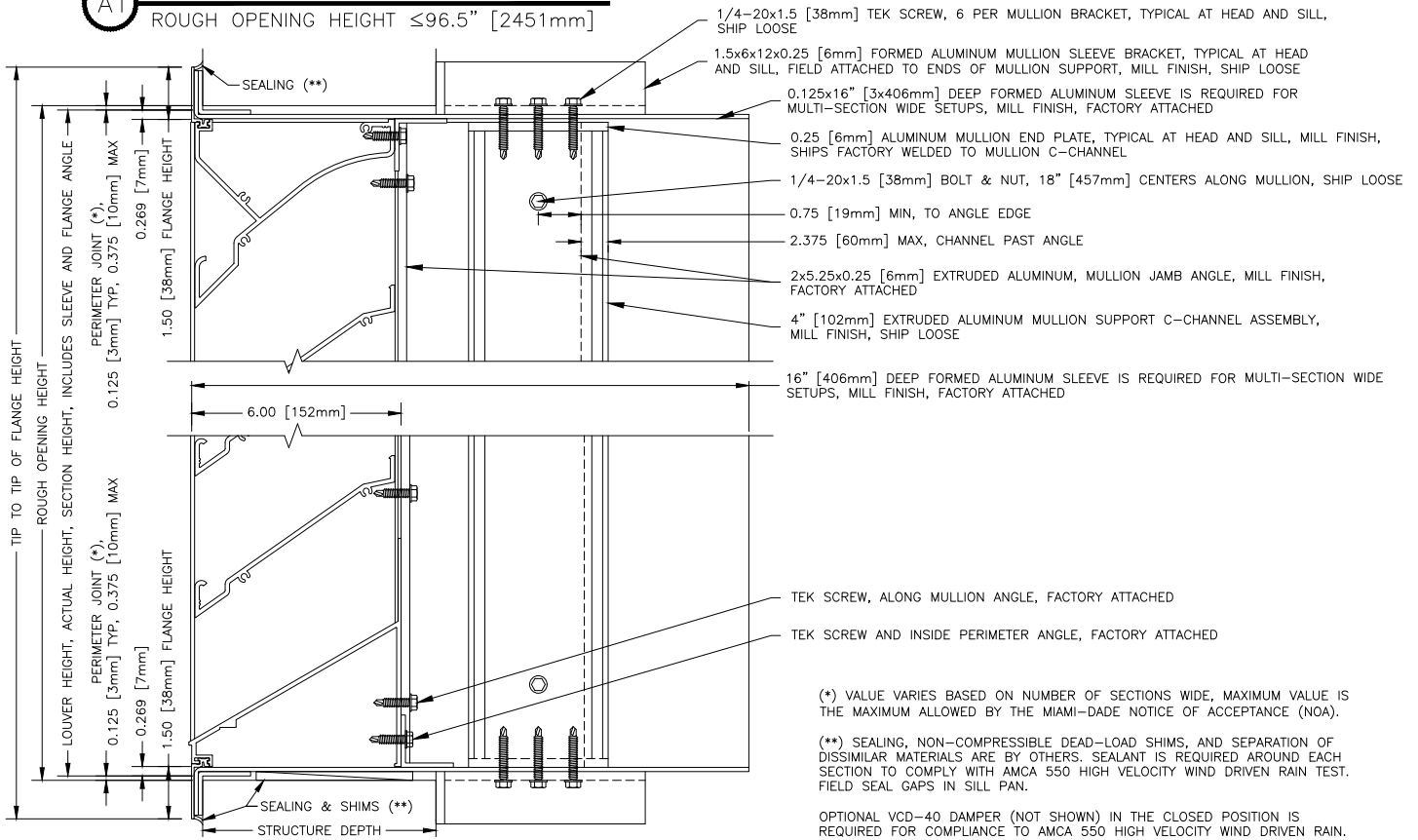

B1 SILL DETAIL, MULLION, SLEEVE FRAME

ROUGH OPENING HEIGHT $\leq 96.5"$ [2451mm]

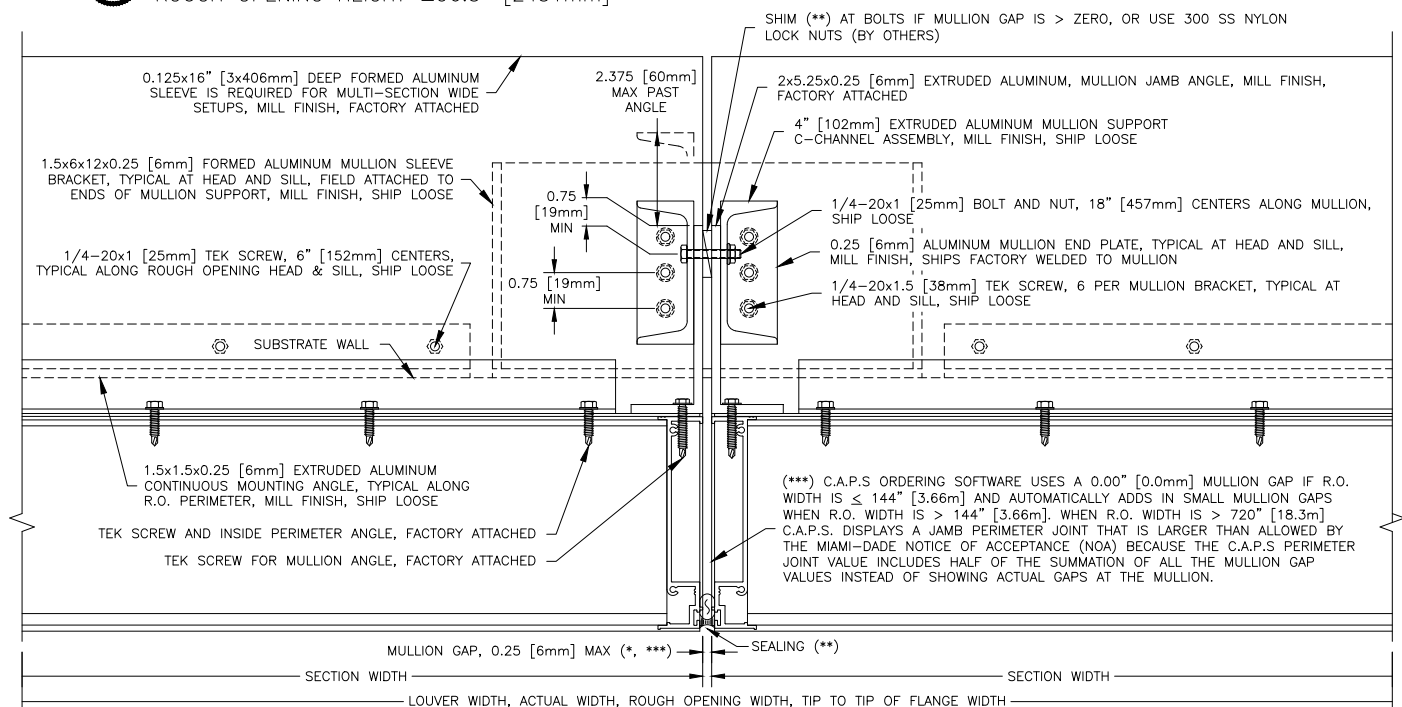

E1 MULLION DETAIL, SLEEVE FRAME

ROUGH OPENING HEIGHT $\leq 96.5"$ [2451mm]

A2 HEAD DETAIL, MULLION, SLEEVE FRAME

ROUGH OPENING HEIGHT >96.5" [2451mm]

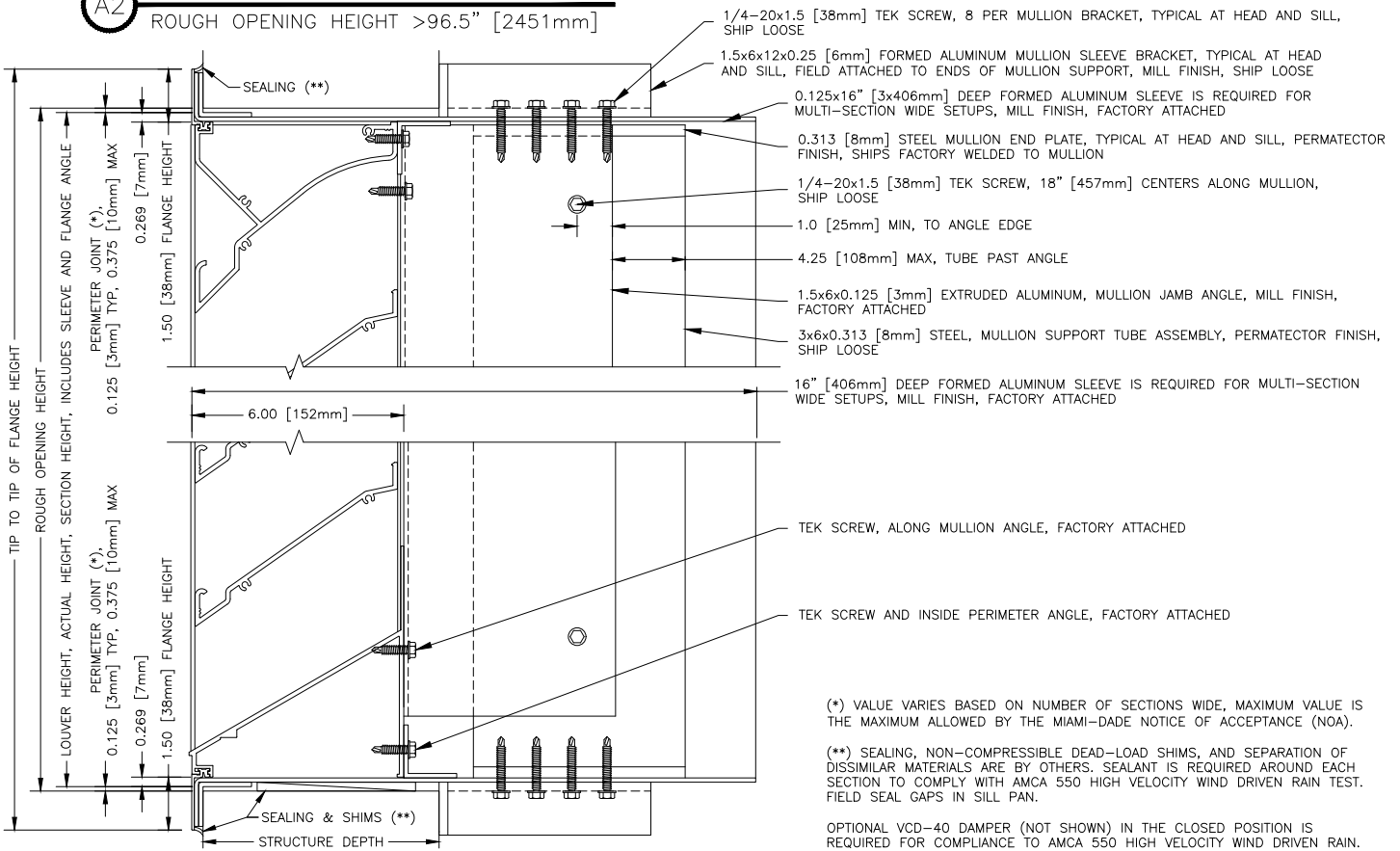

B2 SILL DETAIL, MULLION, SLEEVE FRAME

ROUGH OPENING HEIGHT >96.5" [2451mm]

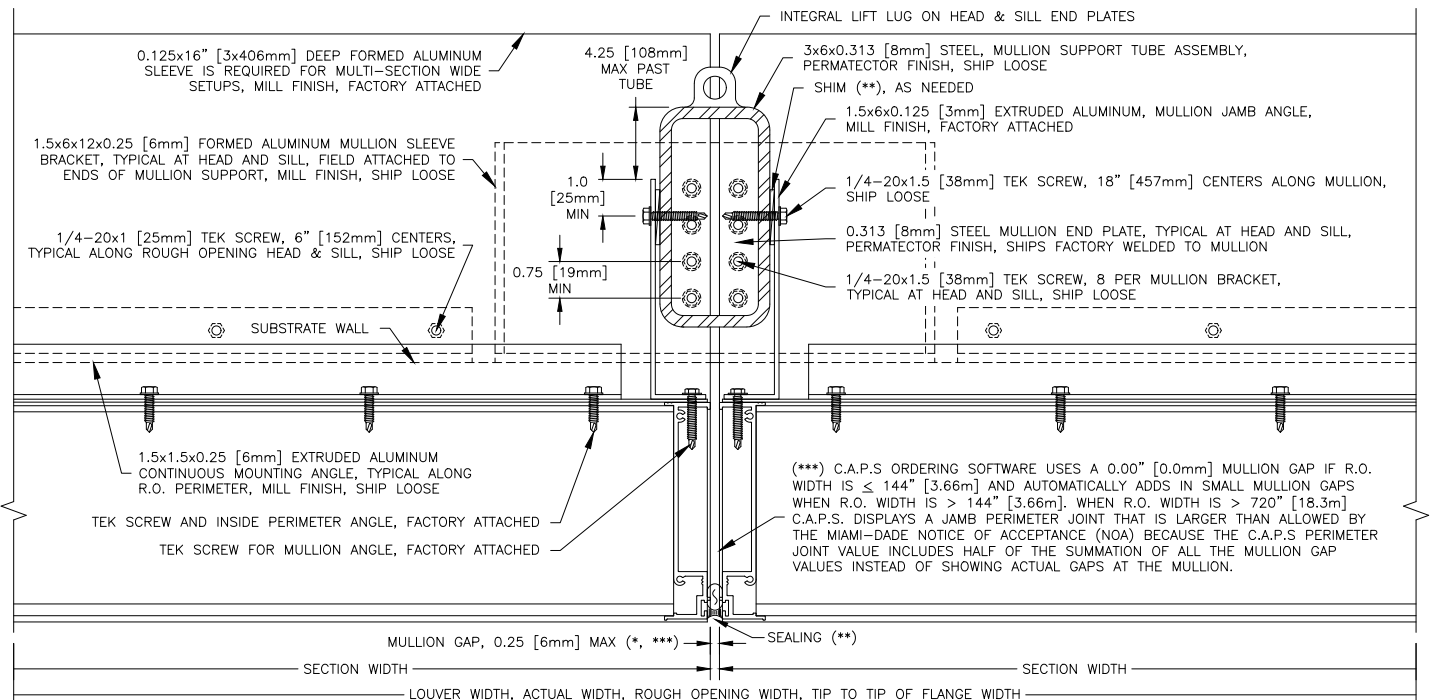

E2 MULLION DETAIL, SLEEVE FRAME

ROUGH OPENING HEIGHT >96.5" [2451mm]

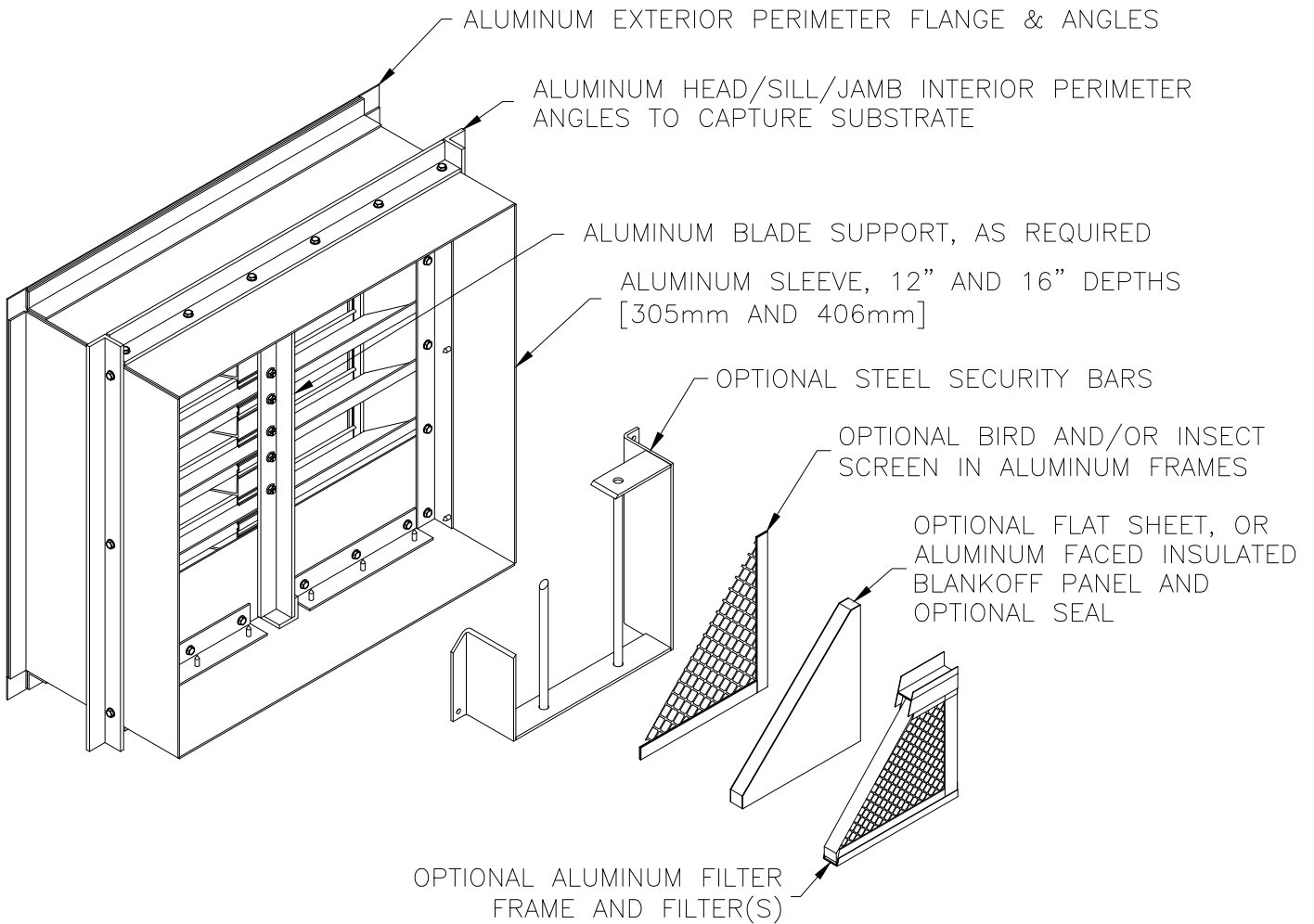

Structure Depth

- Min. structure depth 8.0 in.
- Max. structure depth 10.5 in.

BELOW CONFIGURATION IS FOR ROUGH OPENING
 HEIGHTS $\leq 96.5"$ [2451mm]

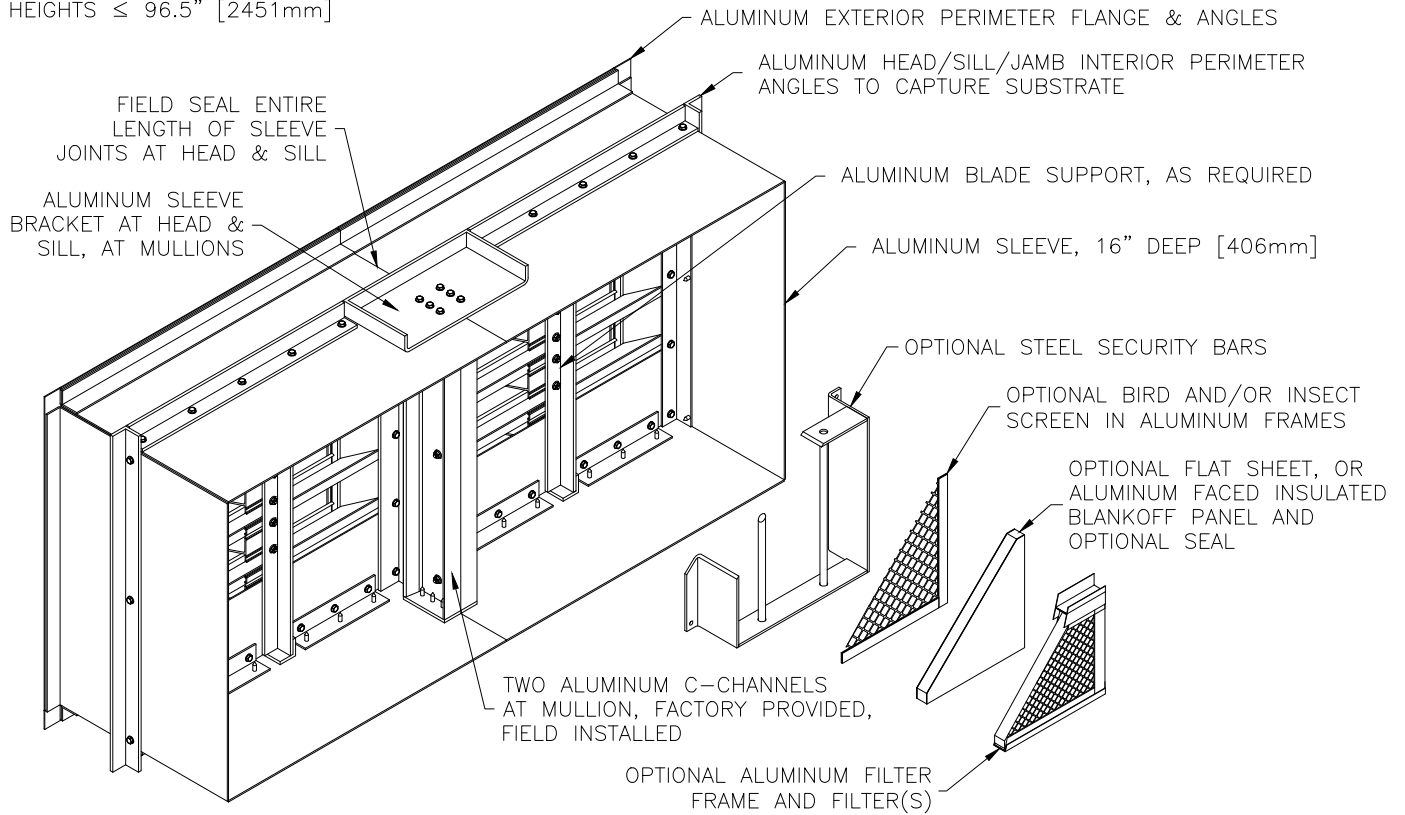

Structure Depth

- Min. structure depth 8.0 in.
- Max. structure depth 11.5 in.

BELOW CONFIGURATION IS FOR ROUGH OPENING HEIGHTS > 96.5" [2451mm]

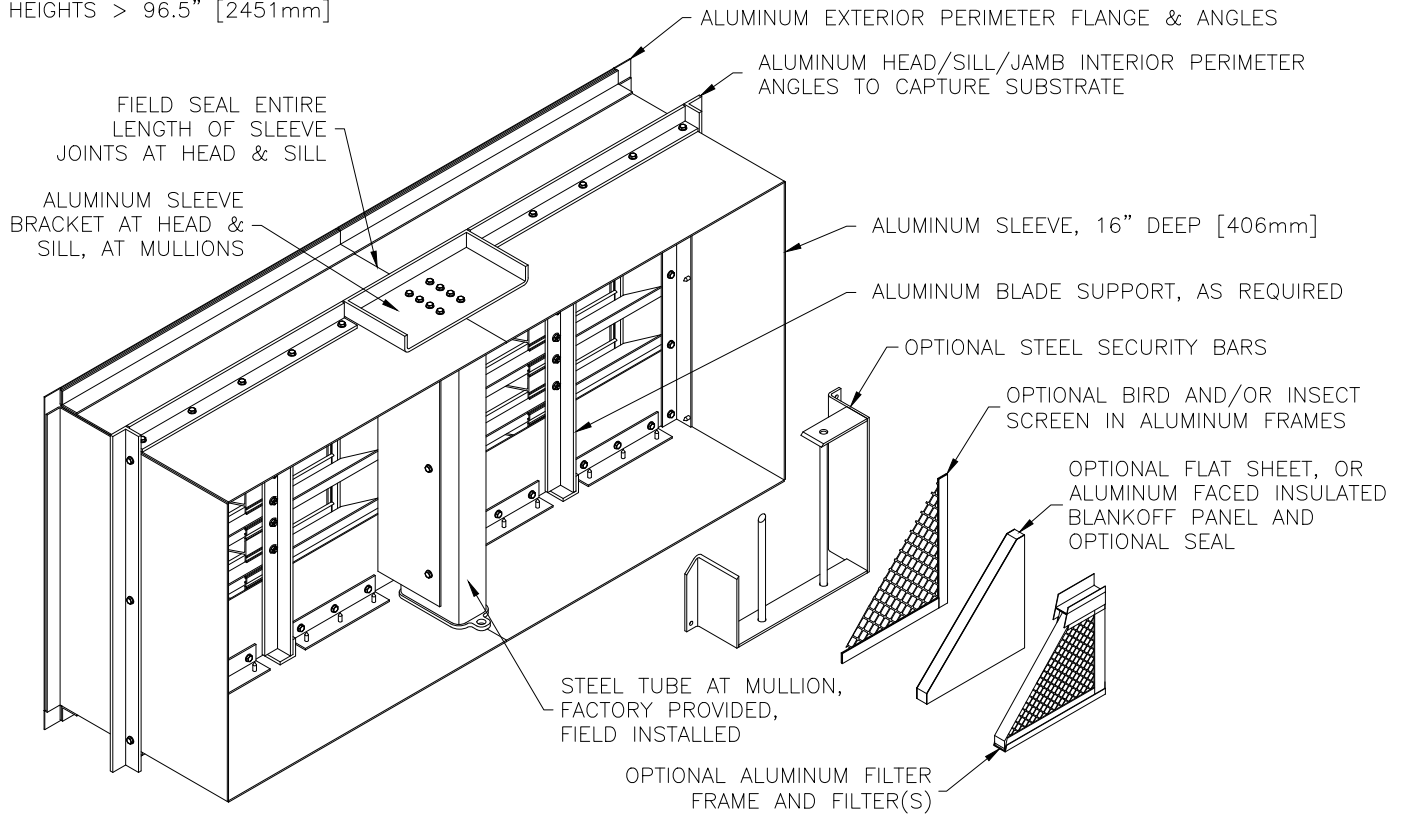

Structure Depth

- Min. structure depth 8.0 in.
- Max. structure depth 13.25 in.



P.O. Box 410, 525 Western Road, Schofield, WI 54476-0410 USA
 715.841.8757 • fax 715.841.8773 • www.airolite.com

As a result of our commitment to continuous improvement, Aiolite reserves the right to change specifications without notice.